

1

INTRODUZIONE
Introduction
Einleitung
Introduction

2

MATERIALI, FINITURE, AVVERTENZE
Materials, Finishes, Warning
Materialien, Oberflächen, Warnung
Matériaux, Finitions, Avertissement

3

MANIGLIE E COORDINATI PER PORTE E FINESTRE
Door handles - Door and window accessories
Türgriffe - Tür und Fenster Zubehör
Poignées de portes - Accessoires pour portes et fenêtres

4

SICUREZZA
Security
Schutzbeschläge
Ensemble béquille de sécurité

5



6



7

MANIGLIE E COORDINATI IN NYLON
Nylon door handles and accessories
Nylon Türgriffe und Zubehör
Poignées de portes en nylon et accessoires

8

COORDINATI PER PORTE SCORREVOLI
Sliding door accessories
Zubehör für Schiebetüren
Accessoires pour portes coulissantes

9

MANIGLIONI
Pull handles
Stossgriffe
Poignées tirantes

10

MANIGLIONI ALZANTI
Pull handle for sliding door
Hebeschiebetürbeschläge
Poignée de tirage pour levant coulissante externe

11

COORDINATI E COMPLEMENTI D'ARREDO - ARTICOLI VARI
Accessories and furniture fittings - Miscellaneous items
Verwirklichungszubehör - Übrige Posten
Accessoires d'accomplissement - Articles divers

12

POMOLI
Knobs
Knöpfe
Boutons

13

BATTENTI
Door knockers
Türklopfer
Heurtoir de porte

14

COORDINATI PER BASCULANTI-PORTE BLINDATE
Accessories for armored door and overhead door
Zubehör für Garagentore und Stahltüren
Accessoires pour porte basculantes et portes blindées

15

COORDINATI PER PORTE DA HOTEL
Accessories for hotel-doors
Zubehör für Türen des Hotels
Accessoires pour portes des hôtels

16

ACCESSORI PER INFISSI ESTERNI
Windows accessories equipment
Fensterzusatzgeräte
Équipement d'accessoires de fenêtre

17

METALMEC

18

ACCESSORI - SCHEMI DI MONTAGGIO
Accessories - Assembly instructions
Zubehör - Montageanleitung
Accessoires - Instructions d'assemblage

19

ESPOSITORI
Displays for samples
Muster-Tafel
Panneaux des échantillons



Stabilimento di Brozzo



Stabilimento di Tavernole



Stabilimento di Vestone



Stabilimento di Ponte Caffaro

Ghidini Pietro Bosco, dal 1929 una lunga storia di maniglie e coordinati. Lo sviluppo dell'azienda, che nasce addirittura nel secolo scorso, si inserisce nella operosa tradizione artigianale, prima, ed industriale, poi, che caratterizza la Val Trompia. Ghidini è uno dei nomi più diffusi nella vallata e quindi dalla cascinetta in località Bosco, dove si svolgeva una impegnativa seconda attività, Pietro mutua il soprannome che lo distingue. Nel 1929 Pietro Ghidini detto Bosco inizia la produzione di maniglie e posate in ottone, e via via, con il crescere della famiglia potenzia la fabbrica sino alle dimensioni di una moderna azienda.

Nel 1950 l'ingresso in azienda dei figli porta, dapprima, alla creazione dei nuovi stabilimenti ed inizia il costante processo d'innovazione tecnologica.

Attualmente, una serie di più recenti acquisizioni impone l'organizzazione di una più vasta realtà produttiva riunita sotto il marchio **Ghidini Group**.

Nel nuovo gruppo imprenditoriale sono quindi oggi compresi:

- **Ghidini**, il marchio storico che ha sede a Brozzo Val Trompia in uno stabilimento che occupa 18000 mq e con unità produttive a Tavernole e Vestone (BS).
- **Ghidini Aluminium**, un nuovo marchio nato dall'acquisizione di un produttore specializzato nella realizzazione di maniglie d'alluminio. La nuova realtà produttiva è localizzata nello stabilimento di Ponte Caffaro (BS).
- **GM**, per la produzione di maniglie e coordinati destinati al contract ed alle grandi forniture per le industrie del settore del serramento.
- **De Venieri**, una produzione creata, con maestri artigiani locali, per rieditare forme e materiali delle antiche maniglie della tradizione.

Il nuovo assetto di **Ghidini Group** risulta quindi essere un sicuro riferimento per il settore riunendo in un solo produttore il più vasto catalogo di soluzioni tecniche e formali per maniglie e coordinati in ottone, bronzo, acciaio inox, lega di zinco, alluminio, nylon e ferro.



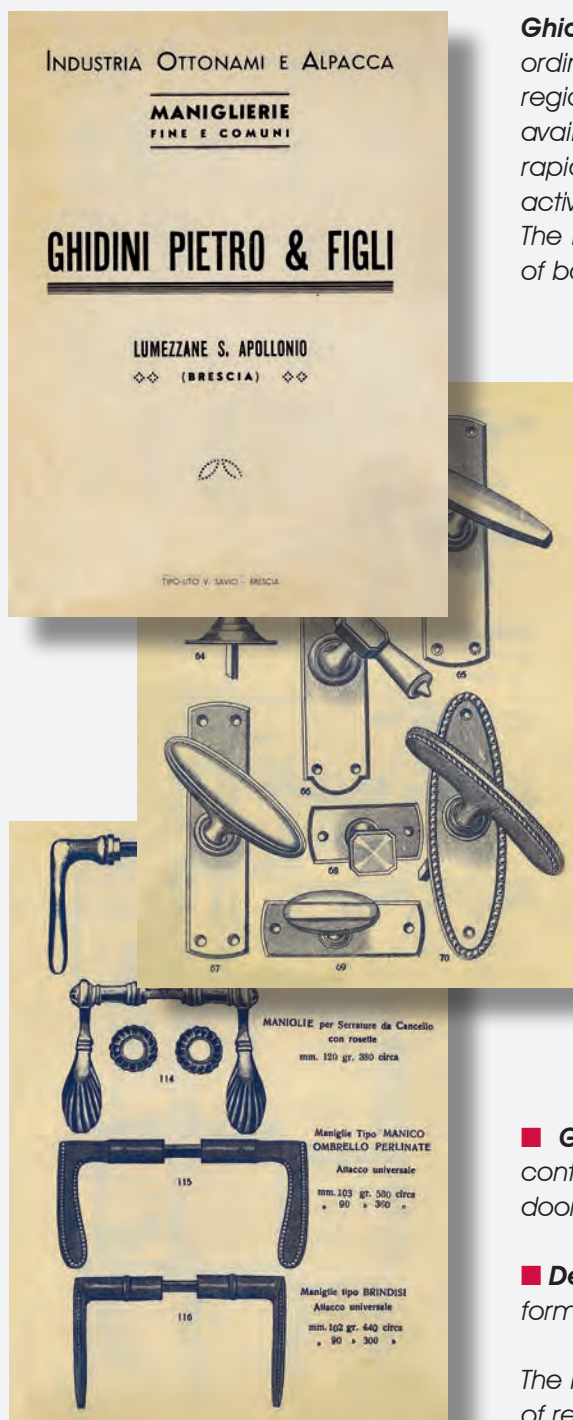

Ghidini Pietro Bosco, a company which makes handles and co-ordinates, with a long history dating back to 1929. Val Trompia, a region at the foot of the mountains whose streams provide easily available hydraulic energy, an area where many workshops rapidly developed alongside the more typical agricultural activities of the mountains.

The history of our company results from this industrious tradition of both skilled labour and agriculture. Ghidini is one of the most typical names in the valley so Pietro took his nickname, for which he has become well-known, from his small farm at Bosco where he also worked.

In 1929 Pietro Ghidini, also known as "Bosco" started manufacturing brass handles and cutlery and gradually, as the family grew the factory developed until it reached the size of the modern company.

In 1950 the sons entered the company which first of all led to the creation of new factories and also started a constant process of technological innovation.

Today a series of more recent acquisitions has made it necessary to organise a much larger manufacturing reality reunited under the **Ghidini Group** trademark. Today the new business group therefore includes:

■ **Ghidini**, the historic brand based in Brozzo Val Trompia in a factory which covers 18,000 with other factories in Tavernole and Vestone (BS).

■ **Ghidini Aluminium**, a new brand which comes from the takeover of a manufacturer specialised in making aluminium handles. These are manufactured in the factory in Ponte Caffaro (BS).

■ **GM**, which manufactures handles and coordinates for contracts and large supplies for industries in the window and door frames sector.

■ **De Venieri**, a product created by local craftsmen, to re-edit forms and materials of the ancient tradition of the handles.

The new structure of the **Ghidini Group** is therefore a sure point of reference for the sector with a single manufacturer offering a wide-ranging catalogue which answers all technical and formal needs with regard to handles and co-ordinates made of brass, stainless steel, zinc alloy, aluminium, nylon and iron.

CERTIFICATE



for the management system according to ISO 9001:2008

The proof of the conforming application with the regulation was furnished and in accordance with certification procedure it is certified for the company

Ghidini Pietro Bosco S.p.A.
Via Pietro Ghidini, 32/34
I – 25060 Brozzo di Marcheno (BS)

Scope

**Design, production and sales of handles and equipments
for doors and windows.**

Certificate Registration No.: TIC 15 100 64249

Valid until: 2015-11-29
Valid from: 2013-01-08

Audit Report No.:

3330 272W G0

Initial certification: 2006-11-30

This certification was conducted in accordance with the TIC auditing and certification procedures and is subject to regular surveillance audits.

TÜV Thüringen e.V.
Certification body for
systems and personnel



Jena, 2013-01-08

Deutsche
Gesellschaft für
Akkuordierung mbH



DGA-ZM-03-06-00



Original certificates
are branded with a hologram

The current validity can be demanded at our homepage www.tuev-thueringen.de.

Zertifizierungsstelle des TÜV Thüringen e.V. • Emsal-Rueke-Ring 8 • D-07745 Jena • ☎ +49 3841 389740 • ✉ zertifizierung@tuev-thueringen.de

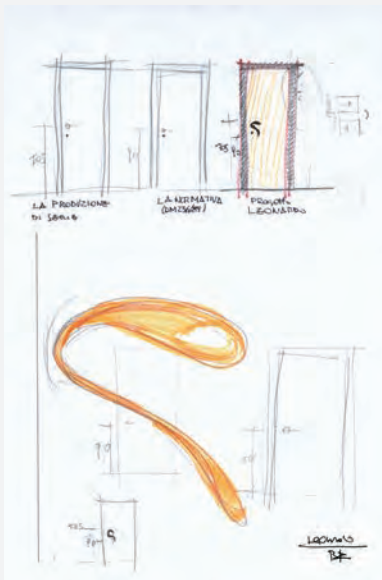

Una lunga tradizione di ricerca e realizzazione, tipica delle produzioni protoindustriali d'inizio secolo, accompagna sin dalla fondazione la storia della Ghidini Pietro Bosco.

Il primo fondatore era un valente artigiano capace di elaborare nuove forme e un attento ricercatore di innovative soluzioni tecnologiche e costruttive. Dal 1929 via via Ghidini ha sviluppato costantemente questa propria peculiarità strutturando al proprio interno un permanente laboratorio di ricerca: Ufficio Esperienze Ghidini, dedicato allo sviluppo di nuovi prodotti ed alla definizione delle più appropriate tecnologie di produzione.

Dagli anni Ottanta poi l'attenzione all'attività di progetto si è propriamente evoluta mediante il costante rapporto con qualificati designer esterni che hanno permesso all'azienda il confronto con nuovi stimoli di ricerca.

La presenza di Ghidini nel dibattito che coinvolge il design del prodotto è ormai largamente affermata come ci dimostrano alcune iniziative che sono di sicuro riferimento nel settore:

- Il periodico "Manua", rivolto ai progettisti ed agli operatori del settore, voluto per approfondire le relazioni tra progetto e tecnologia nel "mondo" delle maniglie, dei coordinati e dei serramenti.
- Il concorso Internazionale di design "La maniglia per il III Millennio", voluto per celebrare i 70 anni dell'azienda che ha consentito una efficace analisi delle tendenze produttive che "aprono" il nuovo millennio.
Da questo concorso nasce "Infinita", una maniglia che risolve in un unico oggetto il rapporto tra placca e leva di manovra.
- Il progetto "Leonardo" è la più significativa innovazione nel settore delle maniglie e risolve in una forma nuova i temi del "design for all".
- Leonardo ha vinto il premio "Vele d'Oro" ad Expocon 2004 ed è stato selezionato per la 19 Biennale di Lubiana, il Premio Costruire, le manifestazioni della Triennale di Milano e del museo della Scienza e della Tecnica, Design Parigi 2005, Piemonte Torino Design ed inoltre le conferenze EIDD.
- DfA Italia (Design for All Italia, membro di EIDD - Design for All Europe) ha assegnato alla maniglia Leonardo il prestigioso marchio di qualità DfA per la sua possibilità di essere usata dalla più ampia categoria di utenti senza porre barriere di tipo funzionale o psicologico.



A long tradition of research and manufacture, typical of the proto-industrial manufacture of the start of the last century, has accompanied the history of Ghidini Pietro Bosco right from its foundation. The first founder was a skilled craftsman capable of creating new shapes who carefully researched innovations in technology and construction. Since 1929 Ghidini has gradually and constantly developed this characteristic creating a permanent research laboratory within the company: the Ghidini Experimental Office, dedicated to the development of new products and the definition of the most appropriate manufacturing techniques. Since the eighties attention to design has developed by working constantly together with qualified external designers who have enabled the company to confront new incentives for research. Ghidini's presence in the debate involving product design is now widely recognised as is shown by some initiatives which are a point of reference in this field:

- The magazine "Manua", produced for designers and workers in this field, which was created to investigate the relationship between design and technology in the "world" of handles, coordinates and door and window frames.
- The International design competition "The handle for the III Millennium", created to celebrate the company's seventy year anniversary which has enabled us to make an effective analysis of the manufacturing trends at the start of the new millennium. This competition led to the creation of "Infinita", a handle which incorporates the plate and lever in just one object.
- The "Leonardo" project is the most significant innovation in the handles sector: with its new shape it answers to the theme "design for all".
- Leonardo won the "Vele d'Oro" prize at Expocon 2004 and has been selected for the 19th Biennial Exhibition in Lubiana, the Construire Prize, and for exhibition at the Triennial exhibition in Milan, the Museum of Science and Technology, Design Paris 2005, Piedmont Turin Design and furthermore the EIDD conferences.
- Dfa Italy (Design for All Italy, member of EIDD – Design for all Europe) has assigned to Leonardo handle the prestigious DFA quality marks for its ability to be used by the largest category of users without placing functional of psychological barriers.



PROGETTO LEONARDO

Il Progetto Leonardo rinnova il rapporto con l'oggetto maniglia indirizzandolo verso un uso ampliato realmente utilizzabile da bambini, adulti, anziani o persone con sedia a ruote. Un disegno semplice e "voluminoso" determina con eleganza le forme della maniglia e consente l'impugnatura a diverse altezze.

Una forma innovativa e gradevole risolve i temi dell'accessibilità e della praticità d'uso senza barriere formali o psicologiche.

Design for all = utenza universale

Il mondo della progettazione si è sempre rivolto ad un modello ideale di utente (ipotizzato già negli studi dell'uomo vitruviano di Leonardo e sino in tempi più recenti dal Modulor di Le Corbusier): un uomo di età media, di buona costituzione fisica che non ammette varianti. Il mondo reale invece è abitato da bambini, giovani, adulti ed anziani, pertanto anche senza tener conto di disabilità gravi l'utente reale non è in grado di usufruire a pienamente ed in modo autonomo le strutture ed i prodotti che la società gli offre. L'uomo di Leonardo non è superato ma deve essere integrato seguendo l'evoluzione di una società che è più attenta alle esigenze di un design for all e cioè universale (per tutti gli utenti). Il progetto deve quindi rivolgersi verso un'utenza più ampia per soddisfare senza barriere fisiche o psicologiche le diverse esigenze abitative di una società reale. La normativa vigente in tema di accessibilità prevede che le maniglie delle porte, solitamente applicate dalla produzione di serie a 105 cm, sia collocata ad altezza 90 cm. Con la maniglia Leonardo si ha la possibilità di impugnare la maniglia a diverse altezze.

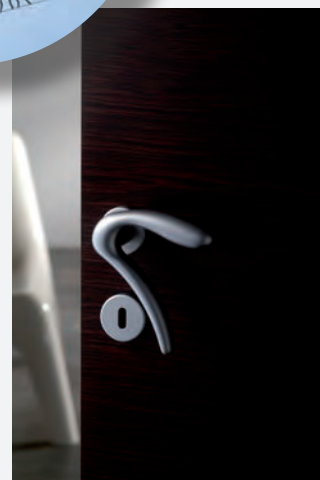
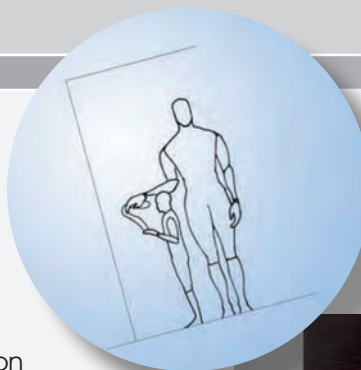

The Leonardo Project takes a new look at our relationship with the handle as an object aimed at a wide range of uses. It really can be used by children, adults, old people and people in wheelchairs.

A simple, voluminous design determines the elegant shape of the handle and makes it possible to grip it at different heights. An innovative and pleasing shape answers the need for accessibility and ease of use without formal or psychological barriers.



Dfa Italia (Design for All Italia, membro di EIDD - Design for All Europe) ha assegnato alla maniglia Leonardo il prestigioso marchio di qualità Dfa.

Dfa Italy (Design for All Italy, member of EIDD - Design for all Europe) has assigned to Leonardo handle the prestigious DFA quality marks for its ability to be used by the largest category of users without placing functional or psychological barriers.

PROGETTO DE VENIERI

Ripercorrendo le antiche tecniche produttive delle botteghe artigiane e dei forni fusori, tradizionalmente operanti sulle sponde del fiume Mella, De Venieri ha compiuto una scelta culturale tanto coraggiosa quanto interessante: ricreare esattamente le forme e l'impatto estetico degli antichi manufatti in bronzo ed in ottone, adoperando materiali, tecniche e processi di finitura coerenti con i valori del progetto.

Ecco perchè i manufatti non vengono neppure sottoposti a trattamenti di superficie moderni, lasciando bensì, che progressivamente il metallo acquisisca una sua identità attraverso la "patina del tempo"; qualcosa di unico e inconfondibile, per arredare case altrettanto personali ed esclusive.

Each piece in the De Venieri line is scrupulously researched from historical sources in order to re-create both the form and aesthetic impact of true artefacts.

Once the design is perfect, it is modelled by hand following age – old foundry and workshop techniques before being finely rendered in either red or white bronze and finished in one of the variety of applied treatments.

From that point onward, these "living object" begin to acquire their own individual identity, responding naturally to the various effects of use and environment and gradually taking on the "Patina of Time".

Likewise, custom-designed articles can be realized with the utmost care and attention to detail befitting the most demanding clientele.

Per maggiori informazioni sul prodotto, e/o per richiedere la brochure "Collezione Devenieri" consultare il sito www.devenieri.com

For more information about the product or to ask for Devenieri Brochure, please visit www.devenieri.com



de venIERI



MATERIALI E FINITURE

Ghidini Group può sicuramente vantare il più ampio catalogo di soluzioni, materiali e finiture presenti sul mercato delle maniglie e dei suoi coordinati.

OTTONE

L'ottone è una lega industriale di rame-zinco, nella quale il tenore di zinco è almeno del 50%. I primi utilizzi del rame e delle sue leghe risalgono a 5000 anni fa. Nel nostro caso la lega rappresenta una parte consistente della produzione e nei nostri stabilimenti viene trasformata dallo stato grezzo a semilavorati mediante processi di pressofusione, stampaggio a caldo, tranciatura e imbutitura, tornitura a seconda che si parta da lingotti, spezzoni di barra estrusa, lamiera, barra trafilata.

ZALOR

Zalor è un marchio registrato con cui indichiamo la speciale lega di zinco, alluminio e magnesio particolarmente adatta per pressofusione con cui produciamo articoli che, dopo operazioni di finitura superficiale, vengono sottoposti a trattamenti galvanici di doratura, nichelatura, rodatura, cromatura nonché all'esclusivo trattamento GHI.CO.TEC.

ALLUMINIO

L'alluminio è sicuramente uno dei metalli non ferrosi più interessanti grazie al suo basso peso specifico ed alla sua buona resistenza alla corrosione che viene notevolmente incrementata mediante ossidazione anodica ed ora anche con l'innovativo trattamento GHI.CO.TEC

NYLON

Nylon è la denominazione commerciale della poliammide 6.6, resina termoplastica sintetica con elevate proprietà meccaniche e buona resistenza agli agenti chimici. Tutta la produzione in Nylon è ottenuta mediante stampaggio per iniezione.

ACCIAIO

L'acciaio è una lega di ferro contenente carbonio fino a circa il 2% ed altri elementi che conferiscono al metallo determinate caratteristiche.

In base al loro impiego gli acciai vengono comunemente divisi in acciai di uso generale e acciai speciali. Gli acciai inossidabili (inox) appartengono a questa seconda categoria ed hanno resistenza all'ossidazione ed alla corrosione, caratteristiche determinate dalla presenza in lega di nichel e cromo.

PRODUCTS AND FINISHES

Ghidini Group can surely boast the largest catalogue of products, materials and finishes available on the handles and coordinates market.

BRASS

Brass is an industrial alloy of copper and zinc, of which zinc makes up at least 50%. The first use of copper and its alloys dates back to 5000 years ago. In our case the alloy represents a consistent part of our production and in our factories it is transformed from the original state to semi-finished products using processes of die casting, hot pressing, blanking and drawing, and turning according to whether the product is manufactured from ingots, cut down sizes of extruded bars, sheet or drawn bars.

ZALOR

Zalor is a registered trademark used to indicate a special alloy of zinc, aluminium and magnesium which is particularly suitable for die casting, used to produce articles which, after surface finishing operations, undergo galvanic treatments with gold, nickel, rhodium and chrome as well as our exclusive GHI.CO.TEC. treatment.

ALUMINIUM

Aluminium is definitely one of the most interesting non-ferrous metals due to its low specific weight and its strong resistance to corrosion. This feature is considerably increased by means of anodic oxidation and now also by using the innovative GHI.CO.TEC treatment.

NYLON

Nylon is the trade name for 6.6 polyamide, a synthetic thermoplastic resin with high mechanical properties and strong resistance to chemical agents. All nylon products are made using injection presses.
STEEL. Steel is an iron alloy containing up to 2% carbon and other elements which give the metal certain characteristics.

STEEL

Steels are commonly divided into steels for general use and steels for specific uses according to their final use.
Stainless steels belong to the second category and resist oxidation and corrosion, a characteristic which is determined by the presence of nickel and chrome in the alloy.



	LEGENDA FINITURE	Finishings legend	Farben Legenda	Légende de finitions
G-PLUS - M36	trattamento PVD	<i>PVD G-PLUS treatment</i>	<i>PVD G-PLUS Beschichtet</i>	<i>PVD G-PLUS traitement</i>
OANT - M75	ottone brunito anticato	<i>Brass antik brown</i>	<i>Messing antik goldbraun</i>	<i>Laiton antique</i>
OBR - M45	ottone brunito	<i>Brass bronzed</i>	<i>Messing brüniert</i>	<i>Laiton bronzé</i>
OCL - M4	ottone cromo lucido	<i>Brass polished chrome</i>	<i>Messing verchromt</i>	<i>Laiton chromé poli</i>
OCS - M18	ottone cromo satinato	<i>Brass satin chrome</i>	<i>Messing verchromt satiniert</i>	<i>Laiton chromé satiné</i>
OF - M3	ottone fumè	<i>Brass fumè</i>	<i>Messing fumè</i>	<i>Laiton fumé</i>
OFA - M69	ottone ferro antico	<i>Brass old iron</i>	<i>Messing Eisen antik</i>	<i>Laiton fer antique</i>
OGV - M27	ottone graffiato verniciato	<i>Brass bronzed scratch</i>	<i>Messing brüniert zerkratzt</i>	<i>Laiton rayé</i>
OLD - MV3	ottone anticato naturale	<i>Brass antique natural</i>	<i>Messing antik Natur</i>	<i>Laiton antique naturel</i>
OLS - M33	ottone lucido-satinato	<i>Brass polished & brushed</i>	<i>Messing poliert-matt</i>	<i>Laiton poli-satiné</i>
OLV - M1	ottone lucido verniciato	<i>Brass polished</i>	<i>Messing poliert</i>	<i>Laiton poli</i>
ONL - M7	ottone nichel lucido	<i>Brass polished nickel</i>	<i>Messing glanznickel</i>	<i>Laiton nickelé poli</i>
ONO - M25	ottone nero opaco	<i>Brass black matt</i>	<i>Messing schwarz matt</i>	<i>Laiton noir mat époxy</i>
ONS - M9	ottone nichel satinato	<i>Brass nickeld matt</i>	<i>Messing nickel matt satiniert</i>	<i>Laiton nickelé-satiné mat</i>
OS - M2	ottone satinato	<i>Brass brushed</i>	<i>Messing matt</i>	<i>Laiton satiné</i>
ZCL	Zalor cromo lucido	<i>Zinc alloy chrome plated</i>	<i>Zamak verchromt</i>	<i>Zamac chromé poli</i>
ZCS	Zalor cromo satinato	<i>Zinc alloy satin chrome</i>	<i>Zamak verchromt satiniert</i>	<i>Zamac chromé satiné</i>
ZNO	Zalor nero opaco	<i>Zinc alloy black matt</i>	<i>Zamak schwarz matt</i>	<i>Zamac noir mat époxy</i>
ZNS	Zalor nichel satinato	<i>Zinc alloy nickeld matt</i>	<i>Zamak nickel matt satiniert</i>	<i>Zamac nickelé-satiné mat</i>
ABI	alluminio bianco RAL 9010	<i>Aluminium white</i>	<i>Aluminium weiss beschichtet</i>	<i>Aluminium époxy blanc</i>
ACL	alluminio cromo lucido	<i>Aluminium polished chrome</i>	<i>Aluminium verchromt poliert</i>	<i>Aluminium poli-chromé</i>
ACP	alluminio cromo perla	<i>Aluminium satin chrome pearl</i>	<i>Aluminium chromt Perla</i>	<i>Aluminium perle-chromé</i>
ANO	alluminio nero opaco	<i>Aluminium black matt textured</i>	<i>Aluminium schwarz matt</i>	<i>Aluminium noir mat</i>
F1	anodizzato argento	<i>Aluminium silver</i>	<i>Aluminium Silber</i>	<i>Aluminium argent</i>
F1-SAT	anodizzato argento satinato	<i>Aluminium brushed silver</i>	<i>Aluminium Silber satiniert</i>	<i>Aluminium argent satiné</i>
F2	anodizzato champagne	<i>Aluminium champagne</i>	<i>Aluminium Neusilber</i>	<i>Aluminium champagne</i>
F3	anodizzato oro	<i>Aluminium gold</i>	<i>Aluminium Gold</i>	<i>Aluminium or</i>
F4	anodizzato bronzo	<i>Aluminium bronze</i>	<i>Aluminium Bronze</i>	<i>Aluminium bronze</i>
F9	anodizzato inox	<i>Aluminium steel</i>	<i>Aluminium Stahl</i>	<i>Aluminium aspect inox</i>
GBR	bronzo verniciato a polvere	<i>Aluminium bronze</i>	<i>Aluminium Bronze beschichtet</i>	<i>Aluminium bronze époxy</i>
GCTCL	GHI.CO.TEC cromo lucido	<i>Like brass polished chrome</i>	<i>Wie Messing verchromt</i>	<i>Alu aspect laiton chromé poli</i>
GCTCS	GHI.CO.TEC cromo satinato	<i>Like brass satin chrome</i>	<i>Wie Messing verchromt satiniert</i>	<i>Alu aspect laiton chromé satiné</i>
GCTOL	GHI.CO.TEC ottone lucido	<i>Like brass polished</i>	<i>Wie Messing poliert</i>	<i>Alu aspect laiton poli</i>
GCTOS	GHI.CO.TEC ottone satinato	<i>Like brass brushed</i>	<i>Wie Messing matt</i>	<i>Alu aspect laiton satiné</i>
NAM	nylon amaranto	<i>Nylon amaranthine</i>	<i>Kunststoff amaranthine</i>	<i>Polyamide amarante</i>
NBI	nylon bianco	<i>Nylon white</i>	<i>Kunststoff verkehrsweiss</i>	<i>Polyamide blanc</i>
NGI	nylon giallo	<i>Nylon yellow</i>	<i>Kunststoff gelb</i>	<i>Polyamide jaune</i>
NGR	nylon grigio	<i>Nylon grey</i>	<i>Kunststoff grau</i>	<i>Polyamide gris</i>
NMA	nylon marrone	<i>Nylon brown</i>	<i>Kunststoff braun</i>	<i>Polyamide marron</i>
NNE	nylon nero	<i>Nylon black</i>	<i>Kunststoff tiefschwarz</i>	<i>Polyamide noir</i>
NRO	nylon rosso	<i>Nylon red</i>	<i>Kunststoff rot</i>	<i>Polyamide rouge</i>
NVE	nylon verde	<i>Nylon green</i>	<i>Kunststoff grün</i>	<i>Polyamide vert</i>

GHI.CO.TEC.

Nel 1995 entra in funzione il nuovo impianto per il trattamento denominato **GHI.CO.TEC.**, **Ghidini Coating Technology**, un nuovo modo di concepire protezione e colorazione di maniglie e coordinati in ottone, Zalor, alluminio.

Mediante un processo di cataforesi **GHI.CO.TEC.** deposita sul metallo resine che aderiscono ad esso per azione di un campo elettrico che si genera nelle vasche in cui i pezzi vengono immersi; con un successivo passaggio a forno la resina si indurisce ed il pezzo assume l'aspetto definitivo.

La resina di base è trasparente ed incolore, ma con l'aggiunta di pigmenti potrebbe assumere qualsiasi colorazione. nel nostro caso utilizziamo la protezione incolore su ottone lucidato e quella "gialla" su Zalor ed alluminio.

Per l'ottone, **GHI.CO.TEC.**, è dunque un'alternativa alla tradizionale verniciatura trasparente. Mentre per Zalor ed alluminio in un unico passaggio, il pezzo si colora, assumendo il tono dell'ottone, e si protegge dall'ossidazione e dall'usura con un deposito diretto sul metallo di base.

Il rivestimento ha uno spessore assolutamente uniforme e garantisce caratteristiche di resistenza ad usura e ossidazione superiori a quanto ottenibile con i trattamenti tradizionali.

Da non trascurare l'aspetto ecologico del processo che lavora completamente a ciclo chiuso, quindi senza scarichi nell'ambiente e senza sviluppo di fumi o sostanze nocive per gli operatori.

*In 1995 the new plant for the **GHI.CO.TEC.**, **Ghidini Coating Technology**, started working. This new plant is a new way to conceive protection and colouring of brass, Zalor or aluminium handles and co-ordinates. By means of a cathoporesis process, **GHI.CO.TEC.** deposits resins on metal and they adhere to it through an electric field which is generated in the bath tank where the pieces are dipped; with a further kiln step, the resin hardens and the piece takes the definite look.*

The basic resin is transparent and colourless, but adding pigments, it can acquire any sort of colour.

In our case we use a colourless protection on polished brass and a "yellow" protection on Zalor or aluminium.

*As far as brass is concerned, **GHI.CO.TEC.** is therefore a great change to the traditional transparent coating. Instead of treating Zalor and aluminium with the usual brass coating galvanized system, with a single **GHI.CO.TEC.** operation, it is possible to colour the article and at the same time give it the right protection from oxidation.*

The coating is absolutely uniform as far as the thickness is concerned and guarantees those characteristics of hardness, adhesion, resistance to solvents and to corrosion in saline fog, with better results compared to those which could be reached by means of traditional treatments.

The ecological aspect has to be taken into account as well, being the process a closed cycle, therefore no emissions in the environment, no fumes or dangerous substances for the operators are developed.





G-PLUS

Ghidini group, proseguendo la propria ricerca che tende ad offrire i migliori caratteri tecnici e formali, presenta **G-PLUS**: il più aggiornato sviluppo della tecnologia PVD (Physical Vapour Deposition) applicata alle maniglie ed ai coordinati.

Superficie dura e compatta, grande resistenza alle abrasioni ed alle aggressioni atmosferiche ed un piacevolissimo colore vivo dell'ottone sono i caratteri che distinguono **G-PLUS**.

G-PLUS realizza rivestimenti ad elevate caratteristiche mediante condensazione sotto vuoto sulla base da rivestire di vapori ottenuti con fattori fisici.

G-PLUS prevede una reazione fisica tra ioni di zirconio che si depositano sulla base in ottone precedentemente nichelata e cromata. La generazione dei vapori avviene per effetto di una scarica ad arco sotto vuoto tra un catodo, ovvero la sorgente dei vapori stessi e la camera in cui avviene l'intero processo.

Le maniglie ed i coordinati trattati con **G-PLUS** godono di caratteristiche ampiamente superiori rispetto a quanto possibile con tutti i trattamenti tradizionali.

Prendendo come termine di confronto la cromatura galvanica otteniamo:

	G-PLUS	Cromatura galvanica
Durezza in HV	2600/2800	800
Resistenza allo sfregamento	600 passate	400 passate
Resistenza alla corrosione in nebbia salina NSS UNI-ISO 9227	1200 ore	700 ore
Resistenza alla corrosione prova Cass-test CASS UNI-ISO 9227	300 ore	180 ore

G-PLUS ha superato severi test di laboratorio che ci consentono di certificare:

- Aderenza 100% secondo la normativa UNI-ISO 4524/5
- Nessuna alterazione dopo 1000 ore di prova accelerata di resistenza alla luce secondo la normativa UNI 9397
- Nessun intacco da parte di acido cloridrico, solforico, nitrico, ossalico, acetico e citrico, soda e potassa caustica, cianuri e sgrassature alcaline a caldo.

I risultati di protezione del trattamento **G-PLUS** permettono, anche ai clienti più esigenti, di ottenere maniglie e coordinati con una superficie di durezza paragonabile all'acciaio, resistenza agli agenti atmosferici che ne permette l'uso anche in esposizioni esterne in ambienti aggressivi, brillantezza del colore dell'ottone grazie alla protezione inalterabile nel tempo, garanzia illimitata perchè la protezione offerta supera anche i limiti di garanzia previsti per legge.

G-PLUS

Carrying on their research in order to offer the best technical and formal features, **GHIDINI group** are presenting **G-PLUS**: the most up to date technological development: PVD (Physical Vapour Deposition) applied to handles and co-ordinates.

Hard and compact surface, great abrasion proof, atmospheric aggression resistant and a very pleasant vivid brass colour are the features which distinguish **G-PLUS**.

G-PLUS is the result of the most innovative deposition technique PVD, by means of which it is possible to carry out coatings having high features through vacuum condensation of vapours obtained with physical factors on the surface to be coated. In the **G-PLUS** case, a physical reaction among zirconium ions (ZrN) which are deposited on the brass surface previously nickel and chromium plated is foreseen. The vapours are originated by means of vacuum discharge pressure between a cathode, that is the source of vapours and the chamber in which the entire process takes place. The handles and coordinates treated with **G-PLUS** have characteristics which are vastly superior compared to what obtainable by means of traditional treatments.

G-PLUS underwent severe laboratory tests which allow us to certify:

- 100% adhesion according to UNI-ISO 425415 Norm.
- No alterations after a 1000 hour accelerated resistance to light test according to UNI 9397 norm.
- No indentation was caused by using hydrochloric, sulphuric, nitric, oxalic, acetic and citric acids, caustic soda and potassium hydroxide, cyanide and alkaline and hot degreasing.

The protective results of **G-PLUS** treatment allow, even to the most demanding customers, to obtain handles and coordinates with a hardened surface which can be compared to steel, which is resistant to external atmospheric agents and which can be placed externally even in saline fog. Thanks to the inalterability of protection, the brass colour brightness doesn't change and an unlimited guarantee due to protection which goes even beyond the limit guarantee foreseen by the law.

G-PLUS a protection unlimited guaranteed for people who want beautiful long lasting handles.





La norma **EN 1906** definisce i requisiti e i metodi di prova per maniglie e pomoli per porte.

Vengono definiti i parametri che definiscono le prestazioni.

La tabella di classificazione è una stringa alfanumerica composta da 8 caratteri.

1	2	3	4	5	6	7	8
Categoria d'utilizzo	Durabilità	Massa della porta	Resistenza al fuoco	Sicurezza (personale)	Resistenza alla corrosione	Sicurezza (contro effrazione)	Tipo di azionamento

1 (prima casella) Categoria d'utilizzo: Le guarniture sono suddivise in 4 categorie d'utilizzo (da 1 a 4), assegnate in riferimento alla frequenza d'utilizzo e al relativo campo applicativo.

1: Utilizzo di media frequenza delle guarniture, da parte di persone che sostanzialmente esercitano un utilizzo accurato e presentano un rischio ridotto per quanto riguarda l'uso non corretto (ad esempio per le porte interne di abitazioni).

Momento di torsione	Trazione	Gioco assiale in posizione di non utilizzo	Gioco perpendicolare sulla maniglia
* 20 Nm	300 N	< 10 mm	< 10 mm

2: Utilizzo di media frequenza delle guarniture, da parte di persone che esercitano un utilizzo sostanzialmente accurato ma che presentano un certo rischio per quanto riguarda l'uso non corretto. (ad esempio per le porte interne di uffici).

Momento di torsione	Trazione	Gioco assiale in posizione di non utilizzo	Gioco perpendicolare sulla maniglia
* 30 Nm	500 N	< 10 mm	< 10 mm

3: Utilizzo ad elevata frequenza delle guarniture, da parte del pubblico o di altre persone, che non hanno particolare cura nell'uso e per le quali esiste un notevole rischio d'utilizzo errato. (ad esempio per le porte di edifici pubblici notevolmente frequentati).

Momento di torsione	Trazione	Gioco assiale in posizione di non utilizzo	Gioco perpendicolare sulla maniglia
* 40 Nm	800 N	< 6 mm	< 5 mm

4: Per impiego su porte che vengono azionate spesso e con forza (ad esempio per porte in stadi da calcio, su piattaforme petrolifere, nelle caserme, toilette pubbliche, ecc).

Momento di torsione	Trazione	Gioco assiale in posizione di non utilizzo	Gioco perpendicolare sulla maniglia
* 60 Nm	1000 N	< 6 mm	< 5 mm

2 (seconda casella) Durabilità: viene inserita la classificazione 6 o 7, 6 = 100.000 cicli di prova , 7 = 200.000 cicli di prova

3 (terza casella) Massa della porta: Non è utilizzata.

4 (quarta casella) Resistenza al fuoco: 0, A, B o C

0 = non adatta per porte tagliafuoco ed antifumo

A = adatta per porte antifumo

B = adatta per porte tagliafuoco ed antifumo

C = adatto per porte tagliafuoco e antifumo, obbligo di un'anima in acciaio nella maniglia

5 (quinta casella) Sicurezza personale: 0 o 1.

(opzionale per cui in questa casella è possibile anche inserire uno 0)

0 = per uso normale

1 = per uso con requisiti di sicurezza . (Secondo DIN 18255, tutte le guarniture per gli edifici pubblici devono superare questa prova corrispondente alle categorie 3 e 4)

6 (sesta casella) Resistenza alla corrosione: da 0 a 5.

0 = nessuna resistenza alla corrosione

1 = resistenza ridotta alla corrosione (test nebbia salina 24 h)

2 = resistenza media alla corrosione (test nebbia salina 48 h)

3 = resistenza alta alla corrosione (test nebbia salina 96 h)

4 = resistenza molto alta alla corrosione (test nebbia salina 240 h)

5 = resistenza estremamente alta alla corrosione (test nebbia salina 480 h)

7 (settima casella) Sicurezza contro l'effrazione: da 0 a 4.

0 = nessuna resistenza allo scasso

1 = ridotta resistenza allo scasso

2 = media resistenza allo scasso

3 = notevole resistenza allo scasso

4 = resistenza estremamente alta allo scasso

8 (ottava casella) Tipo di azionamento: A, B o U.

A = guarnitura con molla

B = guarnitura con precarico a molla

U = guarnitura senza molla

ESEMPIO : guarnitura in alluminio con finitura GHI.CO.TEC, assistita da molla.

(1) Categoria d'utilizzo	(2) Durabilità	(3) Massa della porta	(4) Resistenza al fuoco	(5) Sicurezza personale	(6) Resistenza alla corrosion	(7) Sicurezza effrazione	(8) Tipo di azionamento
3	7	-	0	0	5	0	B



The **EN 1906** standard defines requirements and test methods for door handles and knobs..

The parameters defining the performance are specified below.

The classification table is an alphanumeric string made up of 8 characters.

1	2	3	4	5	6	7	8
Category of use	Durability	Door mass	Fire Resistance	Personal Safety	Corrosion Resistance	Security (in terms of burglary resistance)	Type of operation

1 (first digit) Category of use: Handle sets are classified into 4 categories of use (ranging from 1 to 4), depending on frequency and expected area of use.

1: Medium frequency of use of handle sets, by people with a high incentive to exercise care and with a small chance of misuse (e.g. internal residential doors).

Rotational Torque Strength Test	Axial Strength Test	Free Play "at rest"	Free Angular Movement
* 20 Nm	300 N	< 10 mm	< 10 mm

2: Medium frequency of use of handle sets, by people with some incentive to exercise care but where there is some chance of misuse.
 (e.g. internal office doors).

Rotational Torque Strength Test	Axial Strength Test	Free Play "at rest"	Free Angular Movement
* 30 Nm	500 N	< 10 mm	< 10 mm

3: High frequency of use of handle sets, by the general public or by other people with little incentive to exercise care and with a high chance of misuse.
 (e.g. doors of highly frequented public buildings).

Rotational Torque Strength Test	Axial Strength Test	Free Play "at rest"	Free Angular Movement
* 40 Nm	800 N	< 6 mm	< 5 mm

4: Per impiego su porte che vengono azionate spesso e con forza (ad esempio per porte in stadi da calcio, su piattaforme petrolifere, nelle caserme, toilette pubbliche, ecc).

Rotational Torque Strength Test	Axial Strength Test	Free Play "at rest"	Free Angular Movement
* 60 Nm	1000 N	< 6 mm	< 5 mm

2 (second digit) Durability: the classification figure is either 6 or 7, 6 = 100,000 test cycles, 7 = 200,000 test cycles

3 (third digit) Door Mass: not applicable.

4 (fourth digit) Fire Resistance: 0, A, B or C

0 = not approved for use on fire/smoke doors

A = suitable for use on smoke doors

B = suitable for use on fire/smoke doors

C = suitable for use on fire/smoke doors, steel core in the handle is required

5 (fifth digit) Personal Safety: 0 or 1.

as this is optional, the figure 0 may appear)

0 = normal use

1 = to be used in safety applications. (According to DIN 18255, all handle sets for public buildings - i.e. items included in categories 3 and 4 - must pass this test)

6 (sixth digit) Corrosion Resistance: ranging between 0 and 5.

0 = no corrosion resistance

1 = mild corrosion resistance (24-hr salt-spray test)

2 = moderate corrosion resistance (48-hr salt-spray test)

3 = high corrosion resistance (96-hr salt-spray test)

4 = very high corrosion resistance (240-hr salt-spray test)

5 = extremely high corrosion resistance (480-hr salt-spray test)

7 (seventh digit) Security (in terms of burglary resistance): ranging between 0 and 4.

0 = not approved for use on burglary resistant doors

1 = mild burglary resistance

2 = moderate burglary resistance

3 = high burglary resistance

4 = very high burglary resistance

8 (eighth digit) Type of operation: A, B or U.

A = spring assisted handle set

B = spring loaded handle set

U = unsprung handle set

EXAMPLE: spring assisted aluminum handle set with GHI.CO.TEC. coating

(1) Category of use	(2) Durability	(3) Door Mass	(4) Fire Resistance	(5) Personal Safety	(6) Corrosion Resistance	(7) Security (burglary)	(8) Type of operation
3	7	-	0	0	5	0	B

PROVE E CERTIFICAZIONI IN RIFERIMENTO ALLA NORMATIVA GENERALE UNI EN 1906 TESTING AND CERTIFICATION WITH REFERENCE TO THE GENERAL RULE UNI EN 1906

RESISTENZA ALLA CORROSIONE CORROSION RESISTANCE

UNI EN 1670 - Resistenza alla corrosione: la norma specifica i requisiti di resistenza alla corrosione degli accessori per porte, finestre, chiusure oscuranti e facciate continue. Si applica anche agli elementi di collegamento metallico richiesti per il fissaggio degli accessori per serramenti.

Eseguiamo prove certificate da ente esterno e prove interne con una moderna camera in nebbia salina.

I nostri prodotti sono testati e classificati in riferimento alle normative:

- UNI EN ISO 1670
- UNI EN ISO 9227

UNI EN 1670 Resistance to corrosion: the standard specifies requirements for corrosion resistance of accessories for doors, windows, shutters and curtain walls.

It also applies to metal fasteners required for attachment of accessories for doors.

We perform tests certified by an external organization and we perform also in house tests by a 'salt spray chamber' machinery.

Our products are tested and classified with reference to the following standard:

- UNI EN ISO 1670
- UNI EN ISO 9227



DURABILITÀ DURABILITY

UNI EN 1906 - Durabilità : i nostri prodotti vengono sottoposti a prove di durabilità con test e attrezzature interne, e i risultati (> 280.000 cicli) superano di gran lunga le richieste della normativa:

- frequenza d'uso media: 100 000 cicli.
- frequenza d'uso elevata: 200 000 cicli.

UNI EN 1906 Durability: our products are tested for durability with internal test and equipment, and the results (>280.000 cycles) exceed the requirements of the legislation.

- *Average frequency of use: 100.000 cycles*
- *High frequency of use: 200.000 cycles*

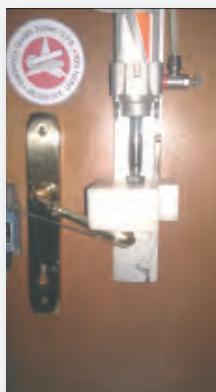

RESISTENZA AL FUOCO FIRE RESISTANCE

UNI EN 1634 - Resistenza al fuoco: i prodotti da utilizzare su porte tagliafuoco / antifumo devono essere conformi ai requisiti appropriati della UNI EN 1906 e ai requisiti supplementari della norma UNI EN 1634.

Uni EN 1634 - Fire resistance : products for use on fire/smoke door must comply with requirements of EN 1906 and to the additional requirements of UNI EN 1634



PRECAUZIONI PER INSTALLATORI ED UTILIZZATORI FINALI

Protezione dall'acido tannico: nelle finestre e porte-finestre in legno di rovere o altre essenza con un elevato contenuto di tannino, assicurarsi che questo non possa evaporare dal legno. La guarnitura non deve avere contatto diretto con una superficie del legno non trattato.

Protezione da sigillante: non utilizzare mai sigillanti a reticolazione acetica o contenenti altre sostanze aggressive, ad esempio acido formico o acetico, composti di ammoniaca, aldeide, fenoli, cloro, tannino ecc., perché sia il contatto diretto con il sigillante che i vapori di queste sostanze possono aggredire la superficie dei particolari.

Durante i lavori in genere, demolizione, ristrutturazione, realizzazione di intonaci e tinteggiatura, riparare le guarniture (comunque tutti i nostri prodotti) dal contatto con polveri, calce, intonaco, tempere e smalti vari. Fare aerare bene il locale prima di togliere le protezioni, il consiglio se possibile sarebbe di montare le guarniture dopo aver eseguito i lavori e dopo essersi assicurati che il locale sia stato ben aerato.

Pulizia e protezione da detergenti aggressivi contenenti acidi: pulire le guarniture esclusivamente con panno morbido e detergenti a pH neutro diluito. Non usare mai detergenti o abrasivi aggressivi contenenti acidi. Questi potrebbero danneggiare le guarniture.

La non osservanza delle suddette indicazioni può causare danni irreparabili al prodotto.

PRECAUTIONS FOR INSTALLATION AND CONSUMERS

Tannic acid protection: in the windows and glass doors in oak or other trees with a high tannin content, make sure that this can not evaporate from the wood. The crank should not have direct contact with a surface of untreated wood.

Sealant protection: Do not use any sealant acetic or other aggressive substances such as formic acid, acetic acid, ammonia compounds, aldehyde, phenol, chlorine, tannin etc..., for a direct contact with the sealant, the vapors of these substances can damage the finishings of the products.

During general maintenance, demolition, renovation, plastering and painting, repairing the cranks (though all of our products) from contact with dust, lime, plaster, tempera and various glazes. Make sure the rooms are ventilated enough before removing the protections. The best advice if possible is to mount the cranks after performing other works and after making sure that the premises was well aerated.

Cleaning and protection from detergents containing acids: clean the cranks only with soft cloth and neutral pH detergent diluted. Never use harsh or abrasive cleaners containing acids. These could damage the crank.

The non-observance of these instructions may cause irreparable damage to the product.

LEGENDA MATERIALI / MATERIALS LEGEND

■ OTTONE / BRASS

■ ALLUMINIO / ALUMINIUM

■ NYLON

■ ZALOR

■ ACCIAIO / STEEL

LEGENDA SIMBOLI / SYMBOLS LEGEND



GUARNITURA CON MOLLA DI RITORNO
HANDLE WITH SPRING



GUARNITURA SENZA MOLLA DI RITORNO
HANDLE WITHOUT SPRING



VITI IN DOTAZIONE
SCREWS PROVIDED



VITI NON IN DOTAZIONE
SCREWS NOT PROVIDED



SPESSORE PORTA GARANTITO CON FERRO QUADRO DI SERIE
DOOR THICKNESS WITH STANDARD SPINDLE

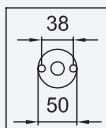

VARIANTE A RICHIESTA RB 50 mm - INTERASSE VITI 38 mm
ON REQUEST

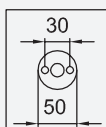

VARIANTE A RICHIESTA RB 50 mm - INTERASSE VITI 30 mm
ON REQUEST

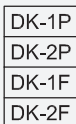

TIPOLOGIA DI GIOCO
TYPE OF MECHANISM

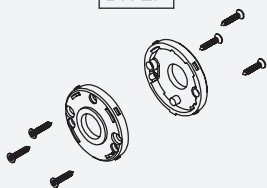



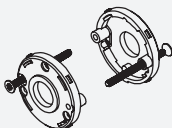



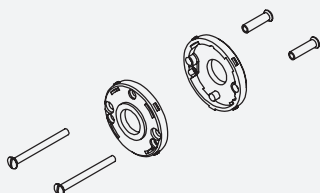







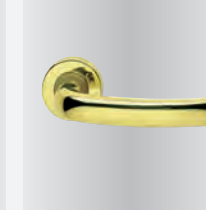

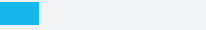
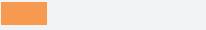

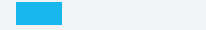
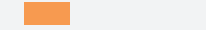
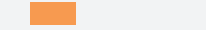





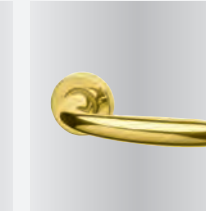
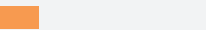
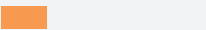

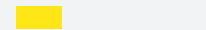
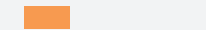
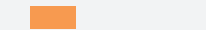



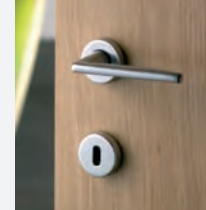
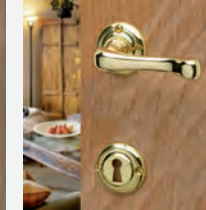

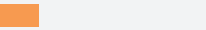
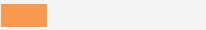
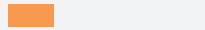
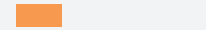
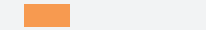





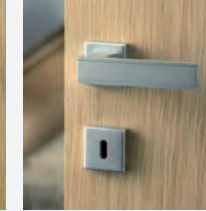

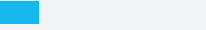
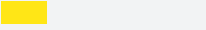
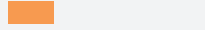
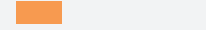
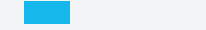
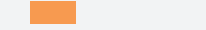

VL = VITI A LEGNO
VL = WOOD SCREWS

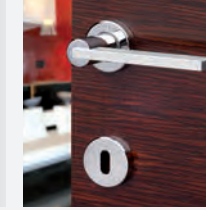

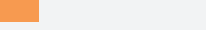
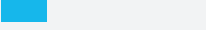
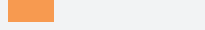
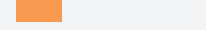

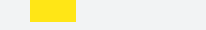

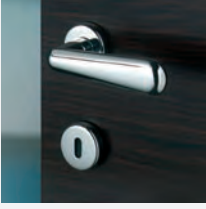
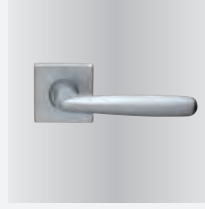
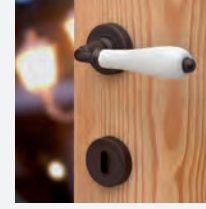
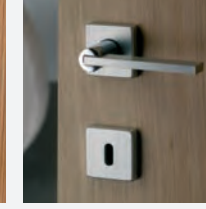
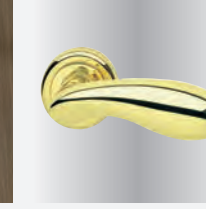
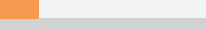
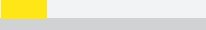
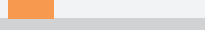
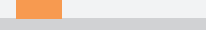

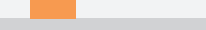

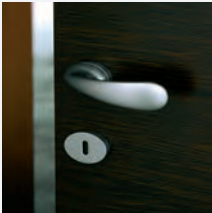
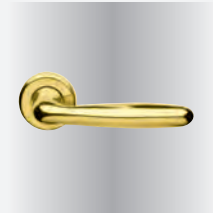
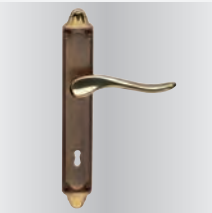

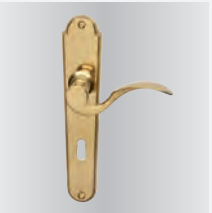









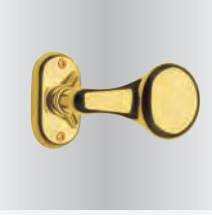

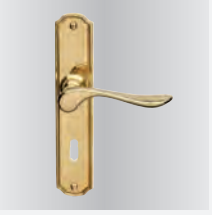
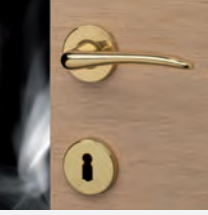
VPA = VITI PASSANTI AUTOFILETTANTI
VPA = THROUGH BOLTS SELF-DRILLING SCREWS

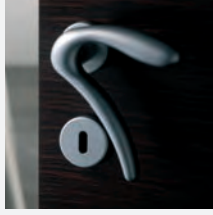

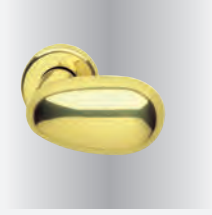
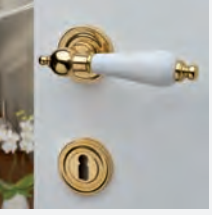
VPM = VITI PASSANTI METRICHE
VPM = THROUGH BOLTS METRIC SCREWS

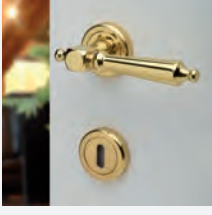
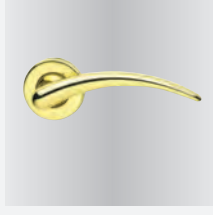
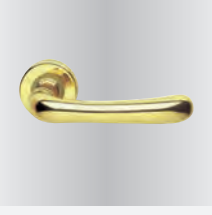
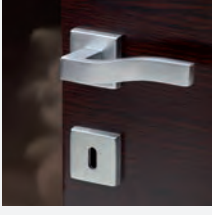
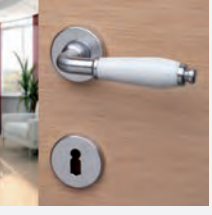
1050 150	ARIETE 168	CARTESIO 22	DAFNE 146	ELY 160	GINEVRA 44
					
					
AIRONE 116	AURORA 162	CARTESIO Q 24-26	DREAM 142	EPOCA 118	GM03 152
					
					
ALEXANDRA 220-222	BAROCCO 238	CHIARA 226	EASY 34	FLORENTIA 174	GM05 132
					
					
ARCHIMEDE 40-42	BELLA 114	CINZIA 52	EASY Q 36	FRAME 6-8	GM06 154
					
					
ARCO 54	BRIXIA 144	COMETA 120	ELBA 158	GALILEO 28	GM07 86
					
					
ARIANNA 210-212	CADDY 38	COMETA Q 122	ELITE 202-204	GALILEO Q 30-32	GOLF 46
					
					

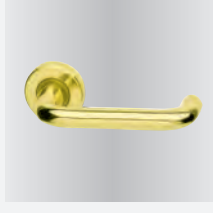
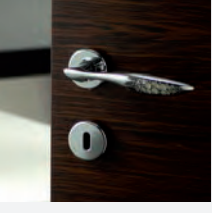
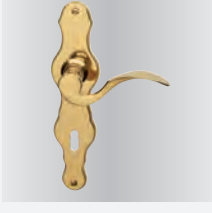
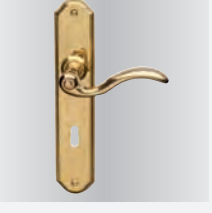
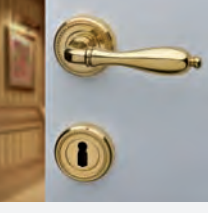
GRAN PRIX 14 	ITACA-2005 148 	MAYA 234 	NOVECENTO 198-200 	R11/23 231 	R716 90-92 
ICEBERG 16 	KELLY 206-208 	MILENA 134-136 	PERLA 216-218 	R1230 74 	R744 94 
IDEA 108 	LADY 236 	MILENA pom. sp. 169 	PIGNA 48 	R31/41 232 	R771 96 
IDEA Q 110-112 	LEONARDO 18 	MILENA-Z 124-138 	PIGNA-2008 50 	R39 176-178 	R774 98 
IMPERO 228 	LORD 156 	MONICA 166 	Q-URVA 2-4 	R5200 194 	R775 100 
INFINITA 20 	MARZIA 164 	MORFEO 10 	R11/21 230 	R54/45 233 	R901 180-182 

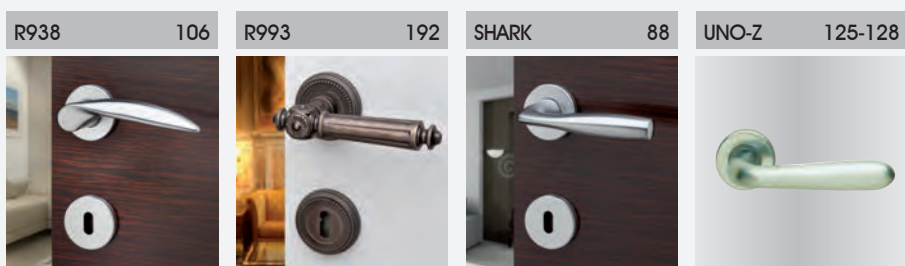
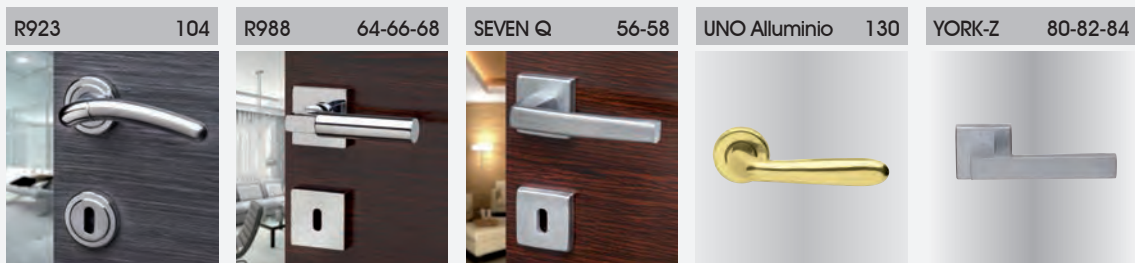
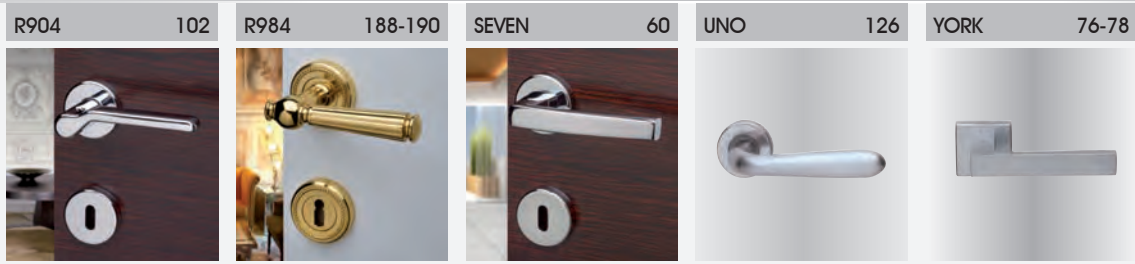

BOCCHETTE, NOTTOLINI,
 MANIGLIERIA PER FINESTRE
*ESCHUTCHEONS, TOILETTE
 SETS, WAINDOWN HANDLES*



BOCCHETTE	246-257
GIOCHI PER CREMONESI	245
GUARNITURA PENDENTE	241
LINDA COLLO BASSO	240



NOTTOLINI WC	258-261
OLIVA CREMONESE MP	243
PLACCHE	265-267
ROSETTE	246-257

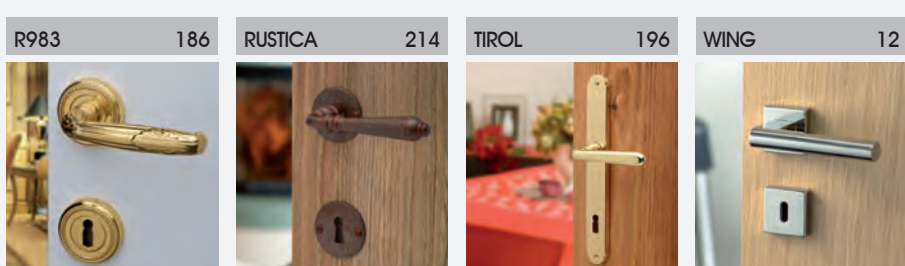

SILVIA CREMONESE MP	242
SMALL	244
TIPOLOGIE DK	262-264



ZCS

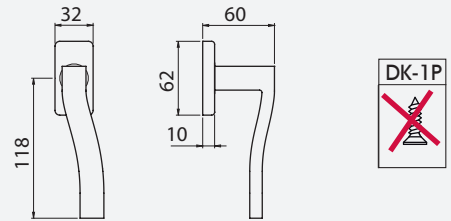
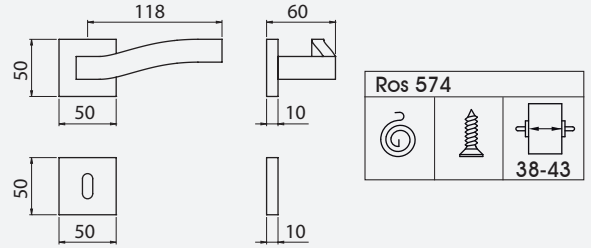

ZCL



ZCS



ZCL

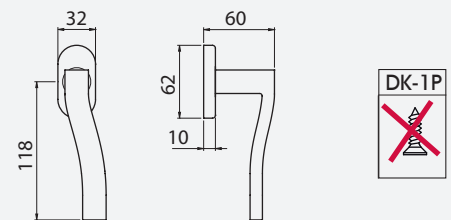
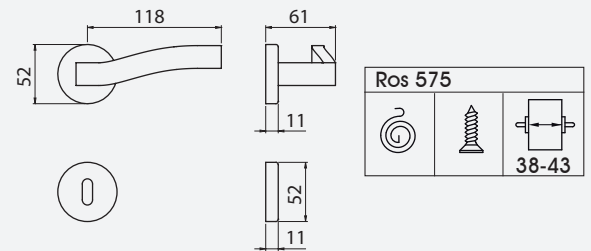

Per maggiori informazioni - For more information:

Rosette da pag. 246 a pag. 257
 Placche da pag. 265 a pag. 267
 DK da pag. 262 a pag. 264

Roses from pag. 246 to pag. 257
 Plates from pag. 265 to pag. 267
 Window handles from pag. 262 to pag. 264

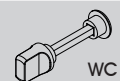

	ZCL	ZCS	ZNS	Conf. pz.
Q8 RQ	66450280007	66450280013	66450280027	
Guarnitura Q8 ros. senza bocc.				1
<i>Lever handle Q8 on rose</i>	34,00	34,00	34,50	
Q8 RBQ	66450281007	66450281013	66450281027	
Guarnitura Q8 ros./bocc. Patent				1
<i>Lever handle Q8 on rose-key escutcheon</i>	42,20	42,20	43,20	
Q8 RBQY	66450285007	66450285013	66450285027	
Guarnitura Q8 ros./bocc. Yale				1
<i>Lever handle Q8 on rose-cyl escutcheon</i>	42,20	42,20	43,20	
Q8 RBQWC	66450288007	66450288013	66450288027	
Guarnitura Q8 ros./bocc. Wc				1
<i>Lever handle Q8 on rose-Wc function</i>	50,30	50,30	52,30	

DK x 40	66450557007	66450557013	66450557027	
Martellina DK Q7 x 40				2
<i>Window handle Q7 DK-tilt & turn handle</i>	16,60	16,60	17,10	
DK x 40 C/BUSS	66450558007	66450558013	66450558027	
Martellina DK Q7 x 40 con bussole D. 9,5				2
<i>Window handle Q7 DK-tilt & turn handle with pins D. 9,5</i>	16,60	16,60	17,10	

Q8 RT	66450280907	66450280913	66450280927	
Guarnitura Q8 ros. senza bocc.				1
<i>Lever handle Q8 on rose</i>	30,80	30,80	31,30	
Q8 RBT	66450281907	66450281913	66450281927	
Guarnitura Q8 ros./bocc. Patent				1
<i>Lever handle Q8 on rose-key escutcheon</i>	36,20	36,20	37,20	
Q8 RBTY	66450285907	66450285913	66450285927	
Guarnitura Q8 ros./bocc. Yale				1
<i>Lever handle Q8 on rose-cyl escutcheon</i>	36,20	36,20	37,20	
Q8 RBTWC	66450288907	66450288913	66450288927	
Guarnitura Q8 ros./bocc. Wc				1
<i>Lever handle Q8 on rose-Wc function</i>	44,20	44,20	46,20	

DK x 40	66450567007	66450567013	66450567027	
Martellina DK Q7 x 40				2
<i>Window handle Q7 DK-tilt & turn handle</i>	15,20	15,20	15,70	
DK x 40 C/BUSS	66450568007	66450568013	66450568027	
Martellina DK Q7 x 40 con bussole D. 9,5				2
<i>Window handle Q7 DK-tilt & turn handle with pins D. 9,5</i>	15,20	15,20	15,70	



ZCS

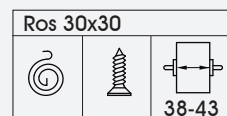
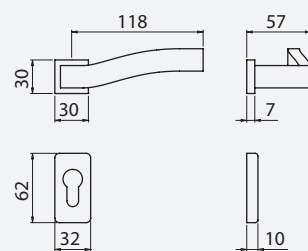
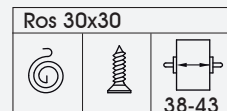
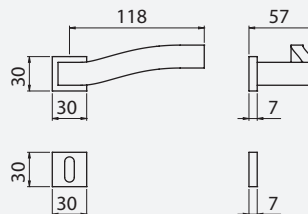

ZCL

Per maggiori informazioni - For more information:

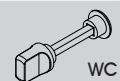

Q-URVA

Design: Ghidini Group

	ZCL	ZCS	ZNS	Conf. pz.
Q8 RBQ 30x30	66450261607	66450261613	66450261627	
Guarnitura Q8 ros./bocc. quadra patent				1
<i>Lever handle Q8 on rose-key escutcheon</i>	42,20	42,20	43,20	

Q8 RQ 30x30 BRettY 30x60	66450265607	66450265613	66450265627	
Guarnitura Q8 ros.quadra bocc.rettangolare Yale				1
<i>Lever handle Q8 on rose-cyl escutcheon</i>	42,20	42,20	43,20	



F1-SAT

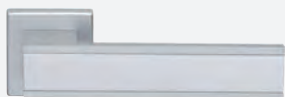
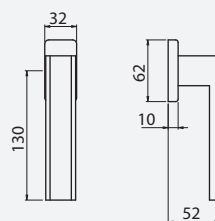
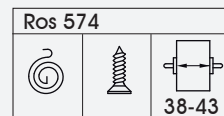
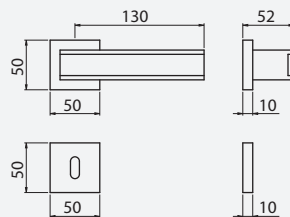

F1-SAT/
GCTCL

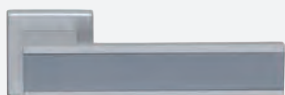

F9-SAT



ARAB



ST



LC



PN

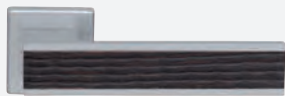

WE

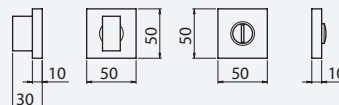

Per maggiori informazioni - For more information:

Rosette da pag. 246 a pag. 257 Roses from pag. 246 to pag. 257
 Placche da pag. 265 a pag. 267 Plates from pag. 265 to pag. 267
 DK da pag. 262 a pag. 264 Window handles from pag. 262 to pag. 264

FRAME

Design: Fabrizio Bianchetti

	F1-SAT	F1-SAT/GCTCL	F1-SAT/F9-SAT	F1-SAT/ARAB	Conf. pz.
Q8 RBQ	77472281033	7747228103324	7747228103334	7747228103374	
Guarnitura Q8 ros./bocc. patent	51,30	53,90	59,10	66,80	1
<i>Lever handle Q8 on rose-key escutcheon</i>					
Q8 RBYQ	77472285033	7747228503324	7747228503334	7747228503374	
Guarnitura Q8 ros./bocc. yale	51,30	53,90	59,10	66,80	1
<i>Lever handle Q8 on rose-cyl escutcheon</i>					
Q8 RBQWC	77472288033	7747228803324	7747228803334	7747228803374	
Guarnitura Q8 ros./bocc.Wc	62,90	65,40	70,60	73,30	1
<i>Lever handle Q8 on rose-WC function</i>					
DK x 40	77472555033	7747255503324	7747255503334	7747255503374	
Martellina DK Q7 x 40	21,20	22,50	24,40	29,90	2
<i>Window handle Q7 DK-tilt & turn handle</i>					
DK x 40 C/BUSS.	77472556033	7747255603324	7747255603334	7747255603374	
Martellina DK Q7 x 40 con bussole D. 9,5	21,20	22,50	24,40	29,90	2
<i>Window handle Q7 DK-tilt & turn handle with pins d.9,5</i>					
	F1-SAT/ST	F1-SAT/LC	F1-SAT/PN	F1-SAT/WE	Conf. pz.
Q8 RBQ	7747228103356	7747228103357	7747228103358	7747228103359	
Guarnitura Q8 ros./bocc. patent	48,50	48,50	48,50	48,50	1
<i>Lever handle Q8 on rose-key escutcheon</i>					
Q8 RBYQ	7747228503356	7747228503357	7747228503358	7747228503359	
Guarnitura Q8 ros./bocc. yale	48,50	48,50	48,50	48,50	1
<i>Lever handle Q8 on rose-cyl escutcheon</i>					
Q8 RBQWC	7747228803356	7747228803357	7747228803358	7747228803359	
Guarnitura Q8 ros./bocc.Wc	60,00	60,00	60,00	60,00	1
<i>Lever handle Q8 on rose-WC function</i>					
DK x 40	7747255503356	7747255503357	7747255503358	7747255503359	
Martellina DK Q7 x 40	20,70	20,70	20,70	20,70	2
<i>Window handle Q7 DK-tilt & turn handle</i>					
DK x 40 C/BUSS.	7747255603356	7747255603357	7747255603358	7747255603359	
Martellina DK Q7 x 40 con bussole D. 9,5	20,70	20,70	20,70	20,70	2
<i>Window handle Q7 DK-tilt & turn handle with pins d.9,5</i>					
	ACL/ST	ACL/LC	ACL/PN	ACL/WE	Conf. pz.
Q8 RBQ	7747228100756	7747228100757	7747228100758	7747228100759	
Guarnitura Q8 ros./bocc. patent	65,50	65,50	65,50	65,50	1
<i>Lever handle Q8 on rose-key escutcheon</i>					
Q8 RBYQ	7747228500756	7747228500757	7747228500758	7747228500759	
Guarnitura Q8 ros./bocc. yale	65,50	65,50	65,50	65,50	1
<i>Lever handle Q8 on rose-cyl escutcheon</i>					
Q8 RBQWC	7747228800756	7747228800757	7747228800758	7747228800759	
Guarnitura Q8 ros./bocc.Wc	77,10	77,10	77,10	77,10	1
<i>Lever handle Q8 on rose-WC function</i>					
DK x 40	7747255500756	7747255500757	7747255500758	7747255500759	
Martellina DK Q7 x 40	26,80	26,80	26,80	26,80	2
<i>Window handle Q7 DK-tilt & turn handle</i>					
DK x 40 C/BUSS.	7747255600756	7747255600757	7747255600758	7747255600759	
Martellina DK Q7 x 40 con bussole D. 9,5	26,80	26,80	26,80	26,80	2
<i>Window handle Q7 DK-tilt & turn handle with pins d.9,5</i>					



F1-SAT

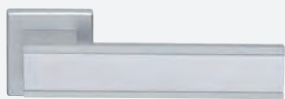
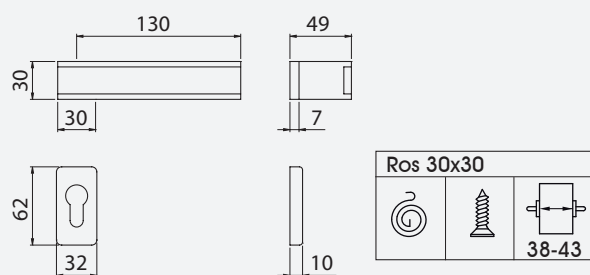
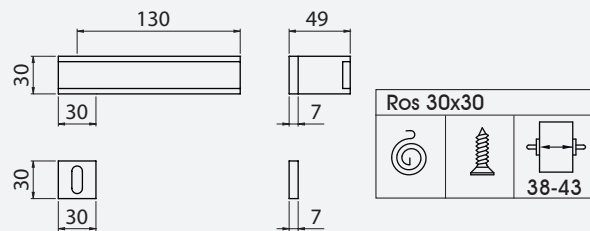

F1-SAT/
GCTCL



F9-SAT



ARAB

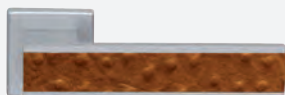

ST



LC



PN

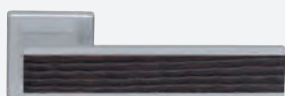

WE

Per maggiori informazioni - For more information:

Rosette da pag. 246 a pag. 257 Roses from pag. 246 to pag. 257
 Placche da pag. 265 a pag. 267 Plates from pag. 265 to pag. 267
 DK da pag. 262 a pag. 264 Window handles from pag. 262 to pag. 264

FRAME

Design: Fabrizio Bianchetti

	F1-SAT	F1-SAT/GCTCL	F1-SAT/F9-SAT	F1-SAT/ARAB	Conf. pz.
Q8 RBQ 30x30	77472261633	7747226163324	7747226163334	7747226163374	
Guarnitura Q8 ros./bocc. quadra patent	51,30	53,90	59,10	66,80	1
<i>Lever handle Q8 on rose-key escutcheon</i>					
Q8 RQ 30x30 BRetY 30x60	77472265633	7747226563324	7747226563334	7747226563374	
Guarnitura Q8 ros.quadra bocc.rettangolare Yale	51,30	53,90	59,10	66,80	1
<i>Lever handle Q8 on rose-cyl escutcheon</i>					
	F1-SAT/ST	F1-SAT/LC	F1-SAT/PN	F1-SAT/WE	Conf. pz.
Q8 RBQ 30x30	7747226163356	7747226163357	7747226163358	7747226163359	
Guarnitura Q8 ros./bocc. quadra patent	48,50	48,50	48,50	48,50	1
<i>Lever handle Q8 on rose-key escutcheon</i>					
Q8 RQ 30x30 BRetY 30x60	7747226563356	7747226563357	7747226563358	7747226563359	
Guarnitura Q8 ros.quadra bocc.rettangolare Yale	48,50	48,50	48,50	48,50	1
<i>Lever handle Q8 on rose-cyl escutcheon</i>					
	ACL/ST	ACL/LC	ACL/PN	ACL/WE	Conf. pz.
Q8 RBQ 30x30	7747226160756	7747226160757	7747226160758	7747226160759	
Guarnitura Q8 ros./bocc. quadra patent	65,50	65,50	65,50	65,50	1
<i>Lever handle Q8 on rose-key escutcheon</i>					
Q8 RQ 30x30 BRetY 30x60	7747226560756	7747226560757	7747226560758	7747226560759	
Guarnitura Q8 ros.quadra bocc.rettangolare Yale	65,50	65,50	65,50	65,50	1
<i>Lever handle Q8 on rose-cyl escutcheon</i>					



ACL

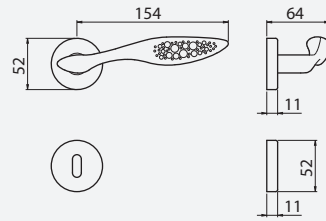

Ros 575		
		38-43

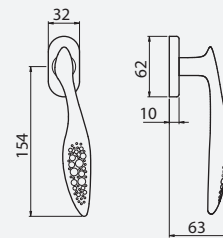

Per maggiori informazioni - For more information:

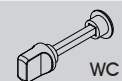

	ACL	Conf. pz.
Q8 R	77962280017	
Guarnitura Q8 ros. senza bocc.	57,10	1
<i>Lever handle Q8 on rose</i>		
Q8 RB	77962281017	
Guarnitura Q8 ros/bocc. patent	62,60	1
<i>Lever handle Q8 on rose-key escutcheon</i>		
Q8 RBY	77962285017	
Guarnitura Q8 ros/bocc. Yale	62,60	1
<i>Lever handle Q8 on rose-cil. escutcheon</i>		
Q8 RBWC	77962288017	
Guarnitura Q8 ros/bocc. Wc	70,50	1
<i>Lever handle Q8 on rose-wc function</i>		
DK x 40	77962557017	
Martellina DK Q7 x 40	31,00	2
<i>Window handle Q7 DK-tilt & turn handle</i>		
DK x 40 C/BUSS.	77962558017	
Martellina DK Q7 x 40 con bussole D. 9,5	31,00	2
<i>Window handle Q7 DK-tilt & turn handle with pins d.9,5</i>		



ACL

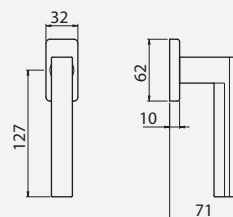
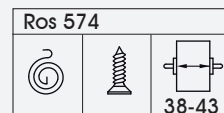
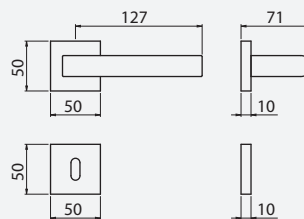

ACS

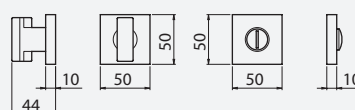

Per maggiori informazioni - For more information:

	ACS	ACL	Conf. pz.
Q8 R	77792280013	77792280017	
Guarnitura Q8 ros. senza bocc.	53,20	53,20	1
<i>Lever handle Q8 on rose</i>			
Q8 RB	77792281013	77792281017	
Guarnitura Q8 ros/bocc. patent	61,20	61,20	1
<i>Lever handle Q8 on rose-key escutcheon</i>			
Q8 RBY	77792285013	77792285017	
Guarnitura Q8 ros/bocc. Yale	61,20	61,20	1
<i>Lever handle Q8 on rose-cil. escutcheon</i>			
Q8 RBWC	77792288013	77792288017	
Guarnitura Q8 ros/bocc. Wc	74,30	74,30	1
<i>Lever handle Q8 on rose-wc function</i>			

DK x 40	77792555013	77792555017	
Martellina DK Q7 x 40	34,30	34,30	2
<i>Window handle Q7 DK-tilt & turn handle</i>			
DK x 40 C/BUSS.	77792556013	77792556017	
Martellina DK Q7 x 40 con bussole D. 9,5	34,30	34,30	2
<i>Window handle Q7 DK-tilt & turn handle with pins d.9,5</i>			



ACP

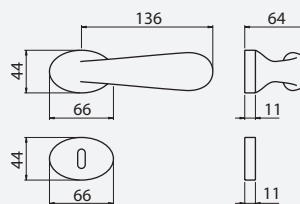

Ros GRAN PRIX		
		38-43

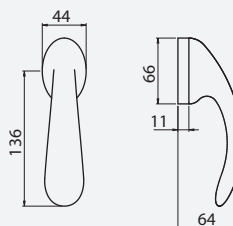

ACL



ANO



Per maggiori informazioni - For more information:

Rosette da pag. 246 a pag. 257
 Placche da pag. 265 a pag. 267
 DK da pag. 262 a pag. 264

Roses from pag. 246 to pag. 257
 Plates from pag. 265 to pag. 267
 Window handles from pag. 262 to pag. 264

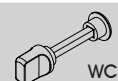

	ACP	ACL	ANO	Conf. pz.
Q8 R	77964280013	77964280017	77964280016	
Guarnitura Q8 ros. senza bocc.	39,70	39,70	37,60	1
<i>Lever handle Q8 on rose</i>				
Q8 RB	77964281013	77964281017	77964281016	
Guarnitura Q8 ros/bocc. patent	47,70	47,70	45,00	1
<i>Lever handle Q8 on rose-key escutcheon</i>				
Q8 RBY	77964285013	77964285017	77964285016	
Guarnitura Q8 ros/bocc. Yale	47,70	47,70	45,00	1
<i>Lever handle Q8 on rose-cil. escutcheon</i>				
Q8 RBWC	77964288013	77964288017	77964288016	
Guarnitura Q8 ros/bocc. Wc	58,60	58,60	56,00	1
<i>Lever handle Q8 on rose-wc function</i>				
DK x 40	77964557013	77964557017	77964557016	
Martellina DK Q7 x 40	20,50	20,50	11,70	2
<i>Window handle Q7 DK-tilt & turn handle</i>				
DK x 40 C/BUSS.	77964558013	77964558017	77964558016	
Martellina DK Q7 x 40 con bussole D. 9,5	20,50	20,50	11,70	2
<i>Window handle Q7 DK-tilt & turn handle with pins d.9,5</i>				



ZCL

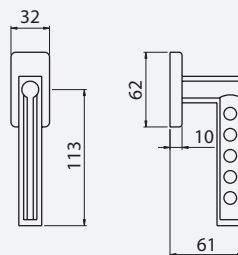
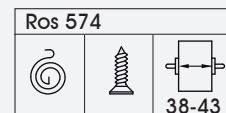
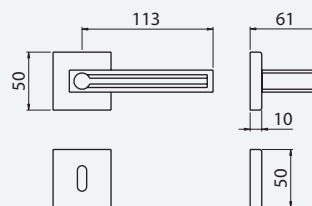

Per maggiori informazioni - For more information:

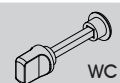

	ZCL	Conf. pz.
Q8 R	66796280007	
Guarnitura Q8 ros. senza bocc.	48,00	1
<i>Lever handle Q8 on rose</i>		
Q8 RB	66796281007	
Guarnitura Q8 ros./bocc. patent	56,30	1
<i>Lever handle Q8 on rose-key escutcheon</i>		
Q8 RBY	66796285007	
Guarnitura Q8 ros/bocc. Yale	56,30	1
<i>Lever handle Q8 on rose-cyl escutcheon</i>		
Q8 RBWC	66796288007	
Guarnitura Q8 ros/bocc. Wc	67,30	1
<i>Lever handle Q8 on rose-wc function</i>		
<hr/>		
DK x 40	66796555007	
Martellina DK Q7 x 40	29,10	2
<i>Window handle Q7 DK-tilt & turn handle</i>		
DK x 40 C/BUSS.	66796556007	
Martellina DK Q7 x 40 con bussole D. 9,5	29,10	2
<i>Window handle Q7 DK-tilt & turn handle with pins d.9,5</i>		



ACP

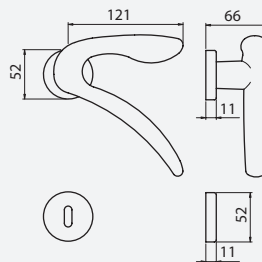

Ros 575		
		38-43

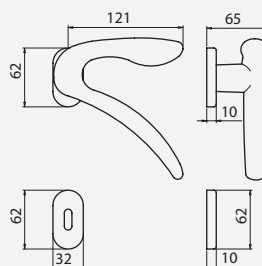

Ros 0006		
		38-43



ACL



ANO



Per maggiori informazioni - For more information:

Rosette da pag. 246 a pag. 257 Roses from pag. 246 to pag. 257
 Placche da pag. 265 a pag. 267 Plates from pag. 265 to pag. 267
 DK da pag. 262 a pag. 264 Window handles from pag. 262 to pag. 264

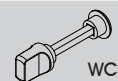

	ACP	ACL	ANO	Conf. pz.
Q8 R	77042280013	77042280017	77042280016	
Guarnitura Q8 ros. senza bocc.	52,00	52,00	37,60	1
<i>Lever handle Q8 on rose</i>				
Q8 RB	77042281013	77042281017	77042281016	
Guarnitura Q8 ros/bocc. patent	59,70	59,70	45,00	1
<i>Lever handle Q8 on rose-key escutcheon</i>				
Q8 RBY	77042285013	77042285017	77042285016	
Guarnitura Q8 ros/bocc. Yale	59,70	59,70	45,00	1
<i>Lever handle Q8 on rose-cil. escutcheon</i>				
Q8 RBWC	77042288013	77042288017	77042288016	
Guarnitura Q8 ros/bocc. Wc	66,50	66,50	50,30	1
<i>Lever handle Q8 on rose-wc function</i>				
Q8 ROC	77042220513	77042220517	77042220516	
Guarnitura Q8 ros.ovale senza bocc.	57,20	57,20	41,40	1
<i>Lever handle Q8 on oval rose</i>				
Q8 RBOC	77042221513	77042221517	77042221516	
Guarnitura Q8 ros/bocc. ovale patent	65,70	65,70	49,50	1
<i>Lever handle Q8 on oval rose-key escutcheon</i>				
Q8 RBOYC	77042225513	77042225517	77042225516	
Guarnitura Q8 ros/bocc. ovale Yale	65,70	65,70	49,50	1
<i>Lever handle Q8 on oval rose-cil. escutcheon</i>				



OCS

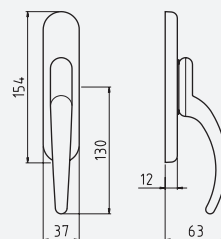
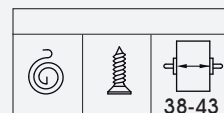
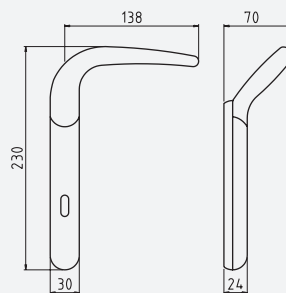

OLV

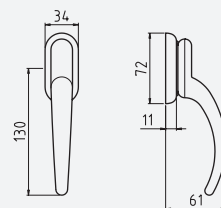

OCL

Per maggiori informazioni - For more information:

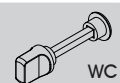

	OLV	OCS	OCL	Conf. pz.
Q8 P90	55940089001	55940089003	55940089007	
Guarnitura Q8 placca patent 90	108,90	136,20	136,20	1
<i>Lever handle Q8 on key plate 90</i>				
Q8 P70	55940087001	55940087003	55940087007	
Guarnitura Q8 placca patent 70	108,90	136,20	136,20	1
<i>Lever handle Q8 on key plate 70</i>				
Q8 PY85	55940088501	55940088503	55940088507	
Guarnitura Q8 placca yale 85	108,90	136,20	136,20	1
<i>Lever handle Q8 on cyl. plate 85</i>				

EZ	55940406001	55940406003	55940406007	
Cremonese gioco EZ	46,40	47,60	47,60	2
<i>Window handle Q7 with mechanism</i>				
EZQ7	55940407001	55940407003	55940407007	
Cremonese gioco EZ + Q7	46,80	48,00	48,00	2
<i>Window handle Q7 with mechanism</i>				
MART	55940500001	55940500003	55940500007	
Martellina Q7	46,40	47,60	47,60	2
<i>Window handle Q7</i>				

DK x 40-35	55940557001	55940557003	55940557007	
Martellina DK Q7 x 40-35	46,40	47,60	47,60	2
<i>Window handle Q7 DK-tilt & turn handle</i>				



OCL-M4/F1

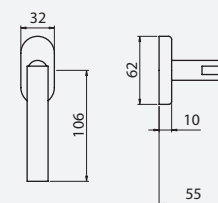
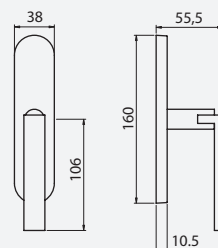
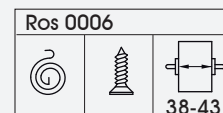
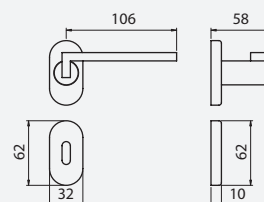
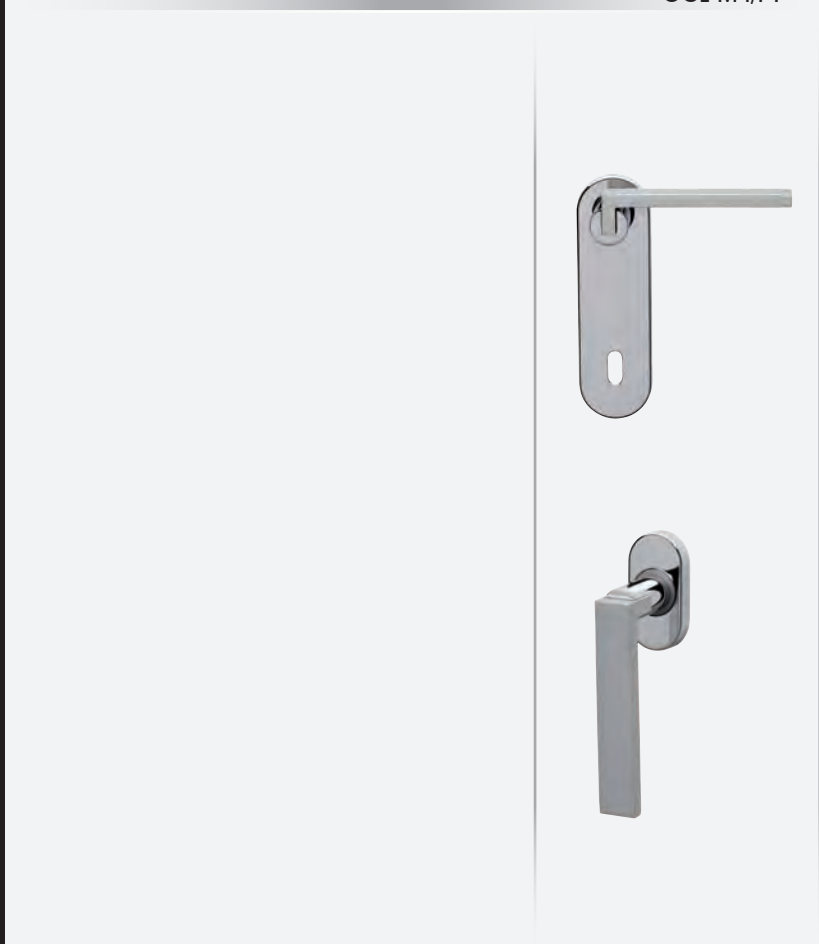
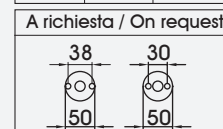
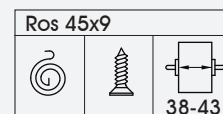
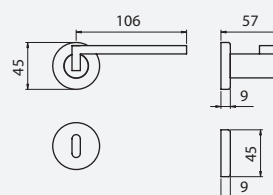
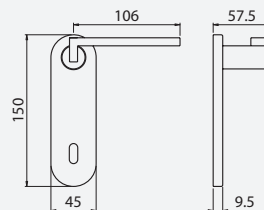

Per maggiori informazioni - For more information:



	OCL-M4/F1	Conf. pz.
Q8 P90 Guarnitura Q8 placca patent 90 <i>Lever handle Q8 on key plate 90</i>	55012089054 41,30	1
Q8 P70 Guarnitura Q8 placca patent 70 <i>Lever handle Q8 on key plate 70</i>	55012087054 41,30	1
Q8 PY85 Guarnitura Q8 placca yale 85 <i>Lever handle Q8 on cyl. plate 85</i>	55012088554 41,30	1
Q8 R Guarnitura Q8 ros. senza bocc. <i>Lever handle Q8 on rose</i>	55012280054 33,20	1
Q8 RB Guarnitura Q8 ros./bocc. patent <i>Lever handle Q8 on rose-key escutcheon</i>	55012281054 38,60	1
Q8 RBY Guarnitura Q8 ros./bocc. yale <i>Lever handle Q8 on rose-cyl escutcheon</i>	55012285054 38,60	1
Q8 RBWC Guarnitura Q8 ros./bocc.Wc <i>Lever handle Q8 on rose-WC function</i>	55012288054 49,60	1
Q8 ROC Guarnitura Q8 ros.ovale senza bocc. <i>Lever handle Q8 on oval rose</i>	55012220554 36,50	1
Q8 RBOC Guarnitura Q8 ros/bocc.ovale patent <i>Lever handle Q8 on oval rose-key escutcheon</i>	55012221554 42,50	1
Q8 RBOYC Guarnitura Q8 ros/bocc.ovale yale <i>Lever handle Q8 on oval rose-cyl escutcheon</i>	55012225554 42,50	1
EZ IM Cremonese gioco EZ imp. maniglia <i>Window handle Q7 with mechanism-lever handle</i>	55012456054 22,00	2
EZQ7 IM Cremonese gioco EZ + Q7 imp. maniglia <i>Window handle Q7 with mechanism-lever handle</i>	55012457054 22,50	2
MART IM Martellina Q7 imp. maniglia <i>Window handle Q7 -lever handle</i>	55012550054 22,00	2
DK x 40 Martellina DK Q7 x 40 <i>Window handle Q7 DK-tilt & turn handle</i>	55012557054 20,90	2
DK x 40 C/BUSS. Martellina DK Q7 x 40 con bussole D. 9,5 <i>Window handle Q7 DK-tilt & turn handle with pins d.9,5</i>	55012558054 20,90	2



OCL-M4/F1

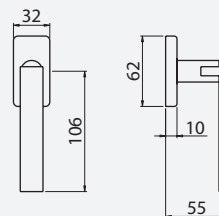
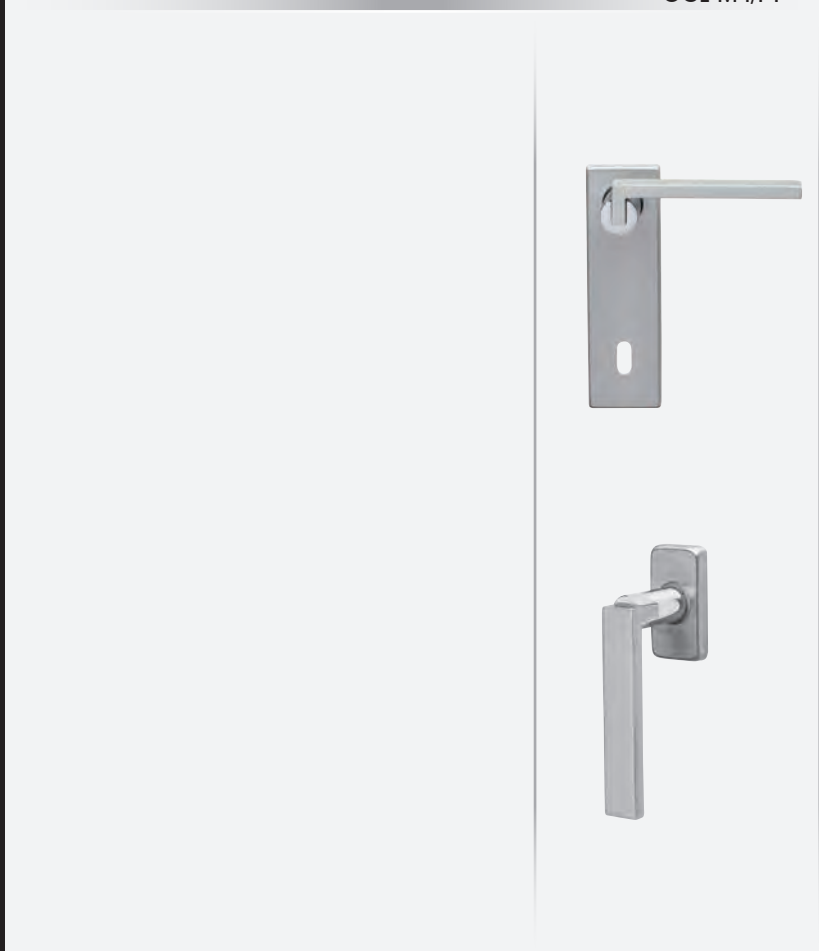
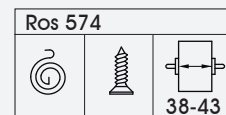
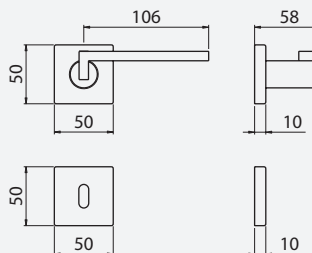
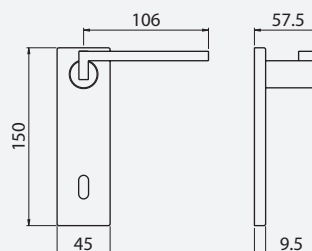

Per maggiori informazioni - For more information:

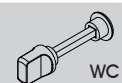

	OCL-M4/F1	Conf. pz.
Q8 P90		
Guarnitura Q8 placca patent 90	44994089054	1
<i>Lever handle Q8 on key plate 90</i>	41,30	
Q8 P70		
Guarnitura Q8 placca patent 70	44994087054	1
<i>Lever handle Q8 on key plate 70</i>	41,30	
Q8 PY85		
Guarnitura Q8 placca yale 85	44994088554	1
<i>Lever handle Q8 on cyl. plate 85</i>	41,30	
Q8 RBQ		
Guarnitura Q8 ros./bocc. patent	44994281054	1
<i>Lever handle Q8 on rose-key escutcheon</i>	41,30	
Q8 RBYQ		
Guarnitura Q8 ros./bocc. yale	44994285054	1
<i>Lever handle Q8 on rose-cyl escutcheon</i>	41,30	
Q8 RBQWC		
Guarnitura Q8 ros./bocc.Wc	44994288054	1
<i>Lever handle Q8 on rose-WC function</i>	52,20	
DK x 40		
Martellina DK Q7 x 40	44994557054	2
<i>Window handle Q7 DK-tilt & turn handle</i>	20,90	
DK x 40 C/BUSS.		
Martellina DK Q7 x 40 con bussole D. 9,5	44994558054	2
<i>Window handle Q7 DK-tilt & turn handle with pins d.9,5</i>	20,90	



OCL-M4/F1

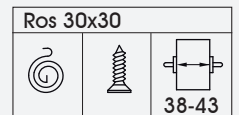
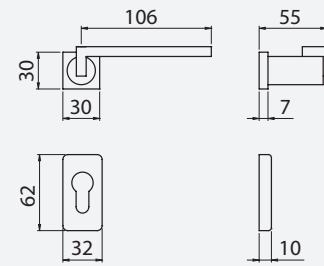
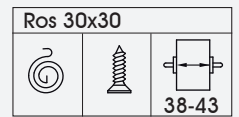
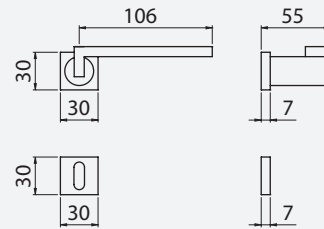

Per maggiori informazioni - For more information:

	OCL-M4/F1	Conf. pz.
Q8 RBQ 30x30	44994261654	1
Guarnitura Q8 ros./bocc. quadra patent		
<i>Lever handle Q8 on rose-key escutcheon</i>	41,30	

Q8 RQ 30x30 BRetY 30x60	44994265654	1
Guarnitura Q8 ros.quadra bocc.rettangolare Yale		
<i>Lever handle Q8 on rose-cyl escutcheon</i>	41,30	



OCL-M4/F1

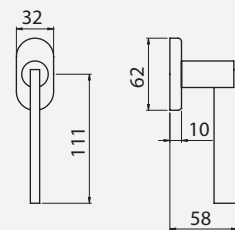
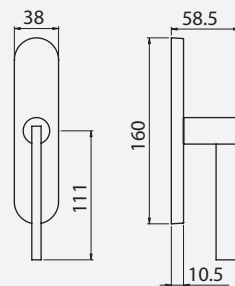
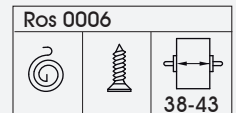
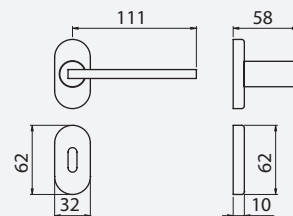
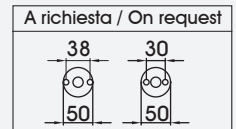
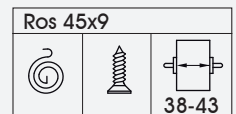
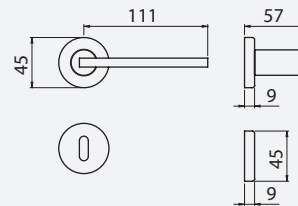
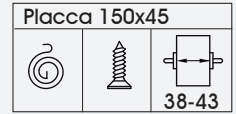
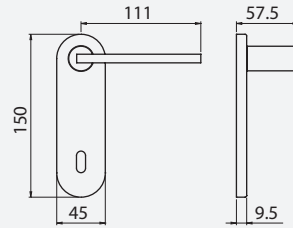

Per maggiori informazioni - For more information:

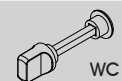

	OCL-M4/F1	Conf. pz.
Q8 P90	55112089054	
Guarnitura Q8 placca patent 90	41,30	1
<i>Lever handle Q8 on key plate 90</i>		
Q8 P70	55112087054	
Guarnitura Q8 placca patent 70	41,30	1
<i>Lever handle Q8 on key plate 70</i>		
Q8 PY85	55112088554	
Guarnitura Q8 placca yale 85	41,30	1
<i>Lever handle Q8 on cyl. plate 85</i>		
Q8 R	55112280054	
Guarnitura Q8 ros. senza bocc.	33,20	1
<i>Lever handle Q8 on rose</i>		
Q8 RB	55112281054	
Guarnitura Q8 ros./bocc. patent	38,60	1
<i>Lever handle Q8 on rose-key escutcheon</i>		
Q8 RBY	55112285054	
Guarnitura Q8 ros./bocc. yale	38,60	1
<i>Lever handle Q8 on rose-cyl escutcheon</i>		
Q8 RBWC	55112288054	
Guarnitura Q8 ros./bocc.Wc	49,60	1
<i>Lever handle Q8 on rose-WC function</i>		
Q8 ROC	55112220554	
Guarnitura Q8 ros.ovale senza bocc.	36,50	1
<i>Lever handle Q8 on oval rose</i>		
Q8 RBOC	55112221554	
Guarnitura Q8 ros/bocc.ovale patent	42,50	1
<i>Lever handle Q8 on oval rose-key escutcheon</i>		
Q8 RBOYC	55112225554	
Guarnitura Q8 ros/bocc.ovale yale	42,50	1
<i>Lever handle Q8 on oval rose-cyl escutcheon</i>		
EZ IM	55112456054	
Cremonese gioco EZ imp. maniglia	22,00	2
<i>Window handle Q7 with mechanism-lever handle</i>		
EZQ7 IM	55112457054	
Cremonese gioco EZ + Q7 imp. maniglia	22,50	2
<i>Window handle Q7 with mechanism-lever handle</i>		
MART IM	55112550054	
Martellina Q7 imp. maniglia	22,00	2
<i>Window handle Q7-lever handle</i>		
DK x 40	55112557054	
Martellina DK Q7 x 40	20,90	2
<i>Window handle Q7 DK-tilt & turn handle</i>		
DK x 40 C/BUSS.	55112558054	
Martellina DK Q7 x 40 con bussole D. 9,5	20,90	2
<i>Window handle Q7 DK-tilt & turn handle with pins d.9,5</i>		



OCL-M4/F1

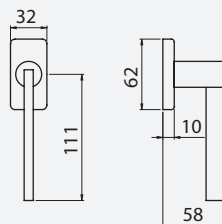
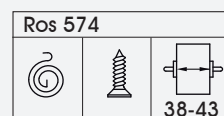
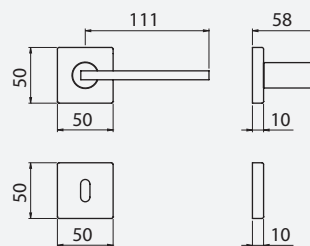
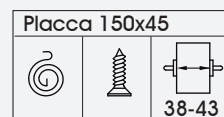
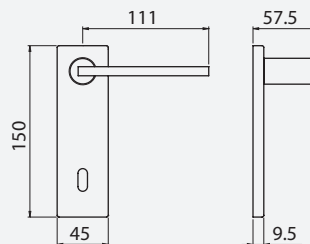

Per maggiori informazioni - For more information:

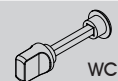

	OCL-M4/F1	Conf. pz.
Q8 P90	44996089054	
Guarnitura Q8 placca patent 90	41,30	1
<i>Lever handle Q8 on key plate 90</i>		
Q8 P70	44996087054	
Guarnitura Q8 placca patent 70	41,30	1
<i>Lever handle Q8 on key plate 70</i>		
Q8 PY85	44996088554	
Guarnitura Q8 placca yale 85	41,30	1
<i>Lever handle Q8 on cyl. plate 85</i>		
Q8 RBQ	44996281054	
Guarnitura Q8 ros./bocc. patent	41,30	1
<i>Lever handle Q8 on rose-key escutcheon</i>		
Q8 RBYQ	44996285054	
Guarnitura Q8 ros./bocc. yale	41,30	1
<i>Lever handle Q8 on rose-cyl escutcheon</i>		
Q8 RBQWC	44996288054	
Guarnitura Q8 ros./bocc.Wc	52,20	1
<i>Lever handle Q8 on rose-WC function</i>		
DK x 40	44996557054	
Martellina DK Q7 x 40	20,90	2
<i>Window handle Q7 DK-tilt & turn handle</i>		
DK x 40 C/BUSS.	44996558054	
Martellina DK Q7 x 40 con bussole D. 9,5	20,90	2
<i>Window handle Q7 DK-tilt & turn handle with pins d.9,5</i>		



OCL-M4/F1

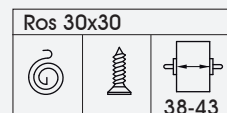
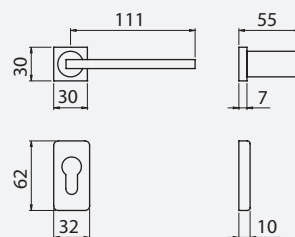
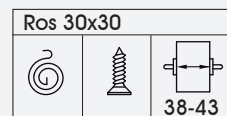
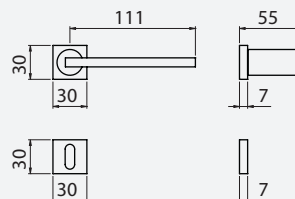

Per maggiori informazioni - For more information:

	OCL-M4/F1	Conf. pz.
Q8 RBQ 30x30	44996261654	1
Guarnitura Q8 ros./bocc. quadra patent	41,30	
<i>Lever handle Q8 on rose-key escutcheon</i>		

Q8 RQ 30x30 BRetY 30x60	44996265654	1
Guarnitura Q8 ros.quadra bocc.rettangolare Yale	41,30	
<i>Lever handle Q8 on rose-cyl escutcheon</i>		



OCS-M18

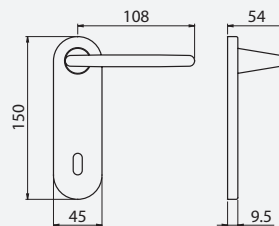

Placca 150x45		
38-43		

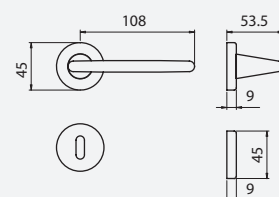

Ros 45x9		
38-43		
A richiesta / On request		
38	30	
50	50	



OLV-M1



OCL-M4

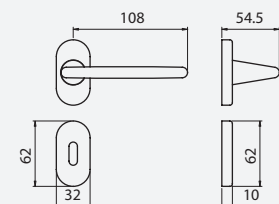

Ros 0006		
38-43		

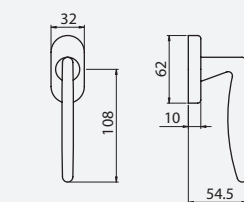
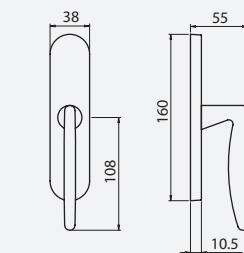

Per maggiori informazioni - For more information:

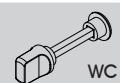

	OLV M1	OCS M18	OCL M4	Conf. pz.
Q8 P90 Guarnitura Q8 placca patent 90 <i>Lever handle Q8 on key plate 90</i>	55014089001 50,40	55014089003 53,60	55014089007 53,60	1
Q8 P70 Guarnitura Q8 placca patent 70 <i>Lever handle Q8 on key plate 70</i>	55014087001 50,40	55014087003 53,60	55014087007 53,60	1
Q8 PY85 Guarnitura Q8 placca yale 85 <i>Lever handle Q8 on cyl. plate 85</i>	55014088501 50,40	55014088503 53,60	55014088507 53,60	1
Q8 R Guarnitura Q8 ros. senza bocc. <i>Lever handle Q8 on rose</i>	55014280001 42,00	55014280003 43,10	55014280007 43,10	1
Q8 RB Guarnitura Q8 ros./bocc. patent <i>Lever handle Q8 on rose-key escutcheon</i>	55014281001 45,20	55014281003 47,30	55014281007 47,30	1
Q8 RBY Guarnitura Q8 ros./bocc. yale <i>Lever handle Q8 on rose-cyl escutcheon</i>	55014285001 45,20	55014285003 47,30	55014285007 47,30	1
Q8 RBWC Guarnitura Q8 ros./bocc.Wc <i>Lever handle Q8 on rose-WC function</i>	55014288001 51,50	55014288003 54,60	55014288007 54,60	1
Q8 ROC Guarnitura Q8 ros.ovale senza bocc. <i>Lever handle Q8 on oval rose</i>	55014220501 43,10	55014220503 44,10	55014220507 44,10	1
Q8 RBOC Guarnitura Q8 ros/bocc.ovale patent <i>Lever handle Q8 on oval rose-key escutcheon</i>	55014221501 48,30	55014221503 50,40	55014221507 50,40	1
Q8 RBOYC Guarnitura Q8 ros/bocc.ovale yale <i>Lever handle Q8 on oval rose-cyl escutcheon</i>	55014225501 48,30	55014225503 50,40	55014225507 50,40	1
EZ IM Cremonese gioco EZ imp. maniglia <i>Window handle Q7 with mechanism-lever handle</i>	55014456001 27,30	55014456003 29,40	55014456007 29,40	2
EZQ7 IM Cremonese gioco EZ + Q7 imp. maniglia <i>Window handle Q7 with mechanism-lever handle</i>	55014457001 28,40	55014457003 30,50	55014457007 30,50	2
MART IM Martellina Q7 imp. maniglia <i>Window handle Q7-lever handle</i>	55014550001 28,40	55014550003 30,50	55014550007 30,50	2
DK x 40-35 Martellina DK Q7 x 40-35 <i>Window handle Q7 DK-tilt & turn handle</i>	55014557001 22,10	55014557003 23,10	55014557007 23,10	2
DK x 40-35 C/BUSS. Martellina DK Q7 x 40-35 con bussole D. 9,5 <i>Window handle Q7 DK-tilt & turn handle with pins d.9,5</i>	55014558001 22,10	55014558003 23,10	55014558007 23,10	2



OCS-M18

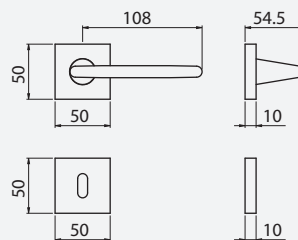

Ros 574		
		38-43

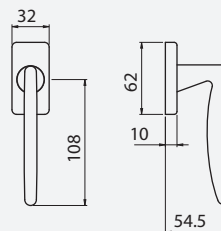

OCL-M4



Per maggiori informazioni - For more information:

Rosette da pag. 246 a pag. 257 Roses from pag. 246 to pag. 257
 Placche da pag. 265 a pag. 267 Plates from pag. 265 to pag. 267
 DK da pag. 262 a pag. 264 Window handles from pag. 262 to pag. 264

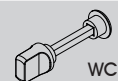

	OLV M1	OCS M18	OCL M4	Conf. pz.
Q8 RQ	55062280001	55062280003	55062280007	
Guarnitura Q8 ros. senza bocc.				1
<i>Lever handle Q8 on rose</i>	47,30	49,40	49,40	
Q8 RBQ	55062281001	55062281003	55062281007	
Guarnitura Q8 ros./bocc. patent				1
<i>Lever handle Q8 on rose-key escutcheon</i>	55,70	57,80	57,80	
Q8 RBQY	55062285001	55062285003	55062285007	
Guarnitura Q8 ros./bocc. yale				1
<i>Lever handle Q8 on rose-cyl escutcheon</i>	55,70	57,80	57,80	
Q8 RBQWC	55062288001	55062288003	55062288007	
Guarnitura Q8 ros./bocc.Wc				1
<i>Lever handle Q8 on rose-WC function</i>	60,90	63,00	63,00	

DK x 40-35	55062557001	55062557003	55062557007	
Martellina DK Q7 x 40-35				2
<i>Window handle Q7 DK-tilt & turn handle</i>	23,10	24,20	24,20	
DK x 40-35 C/BUSS.	55062558001	55062558003	55062558007	
Martellina DK Q7 x 40-35 con bussole D. 9,5				2
<i>Window handle Q7 DK-tilt & turn handle with pins d.9,5</i>	23,10	24,20	24,20	



ZCL

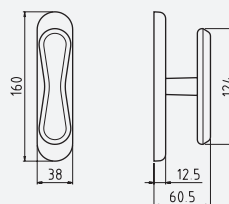
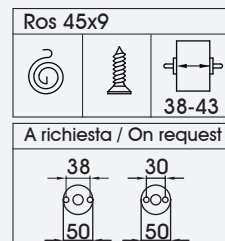
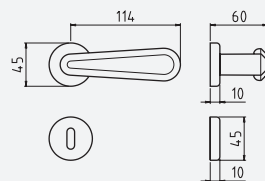

ZCS

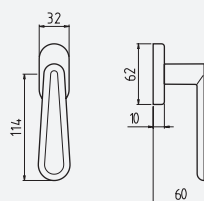

Per maggiori informazioni - For more information:

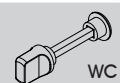

CADDY

Design: Fabrizio Bianchetti

	ZCL	ZCS	Conf. pz.
Q8 R	66084280007	66084280013	
Guarnitura Q8 ros. senza bocc.	29,90	29,90	1
<i>Lever handle Q8 on rose</i>			
Q8 RB	66084281007	66084281013	
Guarnitura Q8 ros./bocc. patent	37,90	37,90	1
<i>Lever handle Q8 on rose-key escutcheon</i>			
Q8 RBY	66084285007	66084285013	
Guarnitura Q8 ros./bocc. yale	37,90	37,90	1
<i>Lever handle Q8 on rose-cyl escutcheon</i>			
Q8 RBWC	66084288007	66084288013	
Guarnitura Q8 ros./bocc.Wc	43,20	43,20	1
<i>Lever handle Q8 on rose-WC function</i>			
EZ	66084406007	66084406013	
Cremonese gioco EZ	25,40	25,40	2
<i>Window handle Q7 with mechanism</i>			
EZQ7	66084407007	66084407013	
Cremonese gioco EZ + Q7	25,80	25,80	2
<i>Window handle Q7 with mechanism</i>			
MART	66084500007	66084500013	
Martellina Q7	25,40	25,40	2
<i>Window handle Q7</i>			
DK x 40	66084557007	66084557013	
Martellina DK Q7 x 40	25,40	25,40	2
<i>Window handle Q7 DK-tilt & turn handle</i>			



F1-SAT

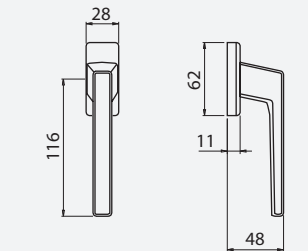
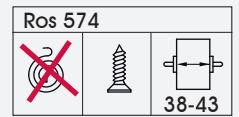
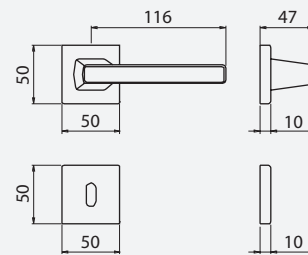
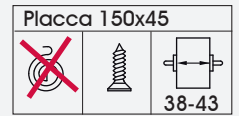
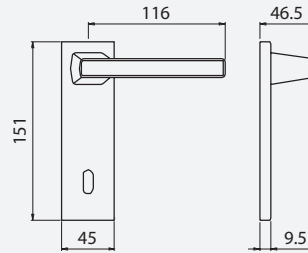

Per maggiori informazioni - For more information:



	F1-SAT	Conf. pz.
Q8 P90		
Guarnitura Q8 placca patent 90	77696089033	1
<i>Lever handle Q8 on key plate 90</i>	20,80	
Q8 P70		
Guarnitura Q8 placca patent 70	77696087033	1
<i>Lever handle Q8 on key plate 70</i>	20,80	
Q8 PY85		
Guarnitura Q8 placca yale 85	77696088533	1
<i>Lever handle Q8 on cyl. plate 85</i>	20,80	
Q8 RBQ		
Guarnitura Q8 ros./bocc. patent	77696211333	1
<i>Lever handle Q8 on rose-key escutcheon</i>	25,60	
Q8 RBYQ		
Guarnitura Q8 ros./bocc. yale	77696215333	1
<i>Lever handle Q8 on rose-cyl escutcheon</i>	25,60	
Q8 RBWCQ		
Guarnitura Q8 ros./bocc.Wc	77696218333	1
<i>Lever handle Q8 on rose-WC function</i>	31,90	
DK x 40		
Martellina DK Q7 x 40	77696555033	2
<i>Window handle Q7 DK-tilt & turn handle</i>	8,70	
DK x 40 C/BUSS.		
Martellina DK Q7 x 40 con bussole D. 9,5	77696556033	2
<i>Window handle Q7 DK-tilt & turn handle with pins d.9,5</i>	8,70	



F1-SAT

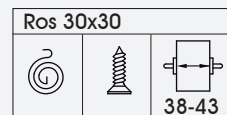
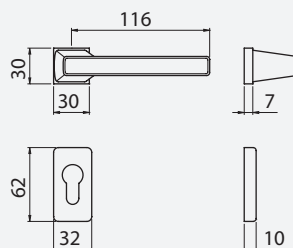
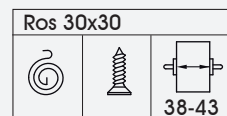
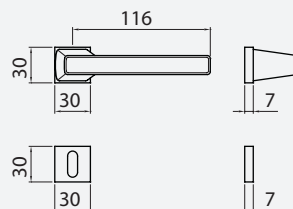

Per maggiori informazioni - For more information:

	F1-SAT	Conf. pz.
Q8 RBQ 30x30		
Guarnitura Q8 ros./bocc. quadra patent	77696261633	1
<i>Lever handle Q8 on rose-key escutcheon</i>	26,80	

Q8 RQ 30x30 BRetY 30x60	77696265633	1
Guarnitura Q8 ros.quadra bocc.rettangolare Yale	26,80	
<i>Lever handle Q8 on rose-cyl escutcheon</i>		



OCL-OCS/M60

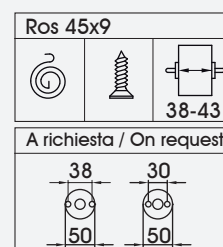
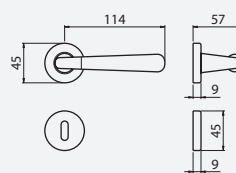
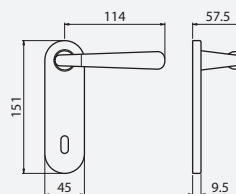

OLS/M33

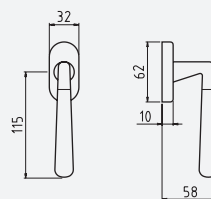
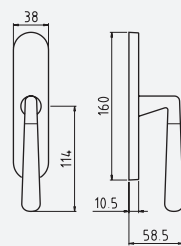
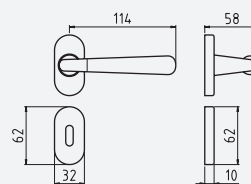

Per maggiori informazioni - For more information:

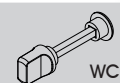

	OLS M33	OCL-OCS M60	Conf. pz.
Q8 P90 Guarnitura Q8 placca patent 90 <i>Lever handle Q8 on key plate 90</i>		5584608900703 50,10	1
Q8 P70 Guarnitura Q8 placca patent 70 <i>Lever handle Q8 on key plate 70</i>		5584608700703 50,10	1
Q8 PY85 Guarnitura Q8 placca yale 85 <i>Lever handle Q8 on cyl. plate 85</i>		5584608850703 50,10	1
Q8 R Guarnitura Q8 ros. senza bocc. <i>Lever handle Q8 on rose</i>	55846230302 40,20	5584623030703 38,60	1
Q8 RB Guarnitura Q8 ros./bocc. patent <i>Lever handle Q8 on rose-key escutcheon</i>	55846231302 43,30	5584623130703 42,00	1
Q8 RBY Guarnitura Q8 ros./bocc. yale <i>Lever handle Q8 on rose-cyl escutcheon</i>	55846235302 43,30	5584623530703 42,00	1
Q8 RBWC Guarnitura Q8 ros./bocc.Wc <i>Lever handle Q8 on rose-WC function</i>	55846238302 49,40	5584623830703 50,70	1
Q8 ROC Guarnitura Q8 ros.ovale senza bocc. <i>Lever handle Q8 on oval rose</i>	55846220502 47,80	5584622050703 42,50	1
Q8 RBOC Guarnitura Q8 ros/bocc.ovale patent <i>Lever handle Q8 on oval rose-key escutcheon</i>	55846221502 65,80	5584622150703 46,20	1
Q8 RBOYC Guarnitura Q8 ros/bocc.ovale yale <i>Lever handle Q8 on oval rose-cyl escutcheon</i>	55846225502 65,80	5584622550703 46,20	1
EZ IM Cremonese gioco EZ imp. maniglia <i>Window handle Q7 with mechanism-lever handle</i>	55846456002 27,40	5584645600703 25,90	2
EZQ7 IM Cremonese gioco EZ + Q7 imp. maniglia <i>Window handle Q7 with mechanism-lever handle</i>	55846457002 27,80	5584645700703 26,30	2
MART IM Martellina Q7 imp. maniglia <i>Window handle Q7 -lever handle</i>	55846550002 27,40	5584655000703 25,90	2
DK x 40-35 Martellina DK Q7 x 40-35 <i>Window handle Q7 DK-tilt & turn handle</i>	55846557002 27,40	5584655700703 21,20	2
DK x 40-35 C/BUSS. Martellina DK Q7 x 40-35 con bussole D. 9,5 <i>Window handle Q7 DK-tilt & turn handle with pins d.9,5</i>	55846558002 27,40	5584655800703 21,20	2

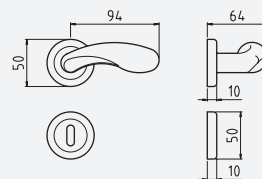

Ros GOLF		
38-43		
A richiesta / On request		
38 	30 	
50	50	

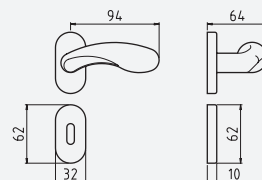

Ros 0006		
38-43		

OLV-M1



OCS-M18



OCL-M4



G-PLUS-M36

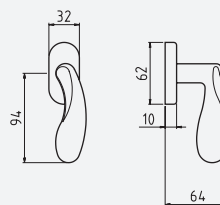
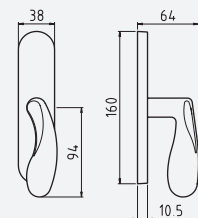

Per maggiori informazioni - For more information:

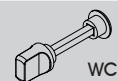

	OLV M1	OCS M18	OCL M4	G-PLUS M36	Conf. pz.
Q8 R Guarnitura Q8 ros. senza bocc. <i>Lever handle Q8 on rose</i>	55146280001 52,00	55146280003 57,80	55146280007 57,80	55146280050 80,60	1
Q8 RB Guarnitura Q8 ros./bocc. patent <i>Lever handle Q8 on rose-key escutcheon</i>	55146281001 68,40	55146281003 76,90	55146281007 76,90	55146281050 103,90	1
Q8 RBY Guarnitura Q8 ros./bocc. Yale <i>Lever handle Q8 on rose-cyl escutcheon</i>	55146285001 68,40	55146285003 76,90	55146285007 76,90	55146285050 103,90	1
Q8 RBWC Guarnitura Q8 ros./bocc.Wc <i>Lever handle Q8 on rose-WC function</i>	55146288001 75,20	55146288003 86,50	55146288007 86,50	55146288050 124,40	1
Q8 ROC Guarnitura Q8 ros.ovale senza bocc. <i>Lever handle Q8 on oval rose</i>	55146220501 57,20	55146220503 63,50	55146220507 63,50	55146220550 88,70	1
Q8 RBOC Guarnitura Q8 ros/bocc.ovale patent <i>Lever handle Q8 on oval rose-key escutcheon</i>	55146221501 75,20	55146221503 84,60	55146221507 84,60	55146221550 114,20	1
Q8 RBOYC Guarnitura Q8 ros/bocc.ovale Yale <i>Lever handle Q8 on oval rose-cyl escutcheon</i>	55146225501 75,20	55146225503 84,60	55146225507 84,60	55146225550 114,20	1
EZ IM Cremonese gioco EZ imp. maniglia <i>Window handle Q7 with mechanism-lever handle</i>	55146456001 47,80	55146456003 57,40	55146456007 57,40	55146456050 71,80	2
EZQ7 IM Cremonese gioco EZ + Q7 imp. maniglia <i>Window handle Q7 with mechanism-lever handle</i>	55146457001 48,20	55146457003 57,80	55146457007 57,80	55146457050 72,20	2
MART IM Martellina Q7 imp. maniglia <i>Window handle Q7-lever handle</i>	55146550001 47,80	55146550003 57,40	55146550007 57,40	55146550050 71,80	2
DK x 40 Martellina DK Q7 x 40 <i>Window handle Q7 DK-tilt & turn handle</i>	55146557001 47,80	55146557003 57,40	55146557007 57,40	55146557050 71,80	2

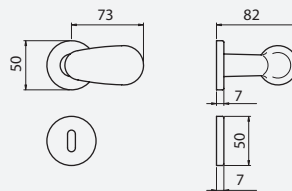

Ros 0005		
		38-43
A richiesta / On request		
50	50	

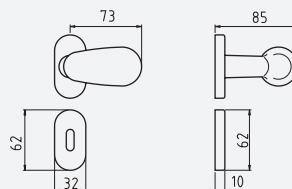

Ros 0006		
		38-43

OCS-M18



OLV-M1



OCL-M4



G-PLUS-M36

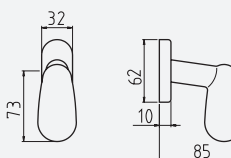
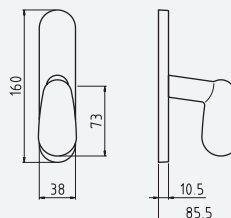

Per maggiori informazioni - For more information:

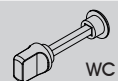

	OLV M1	OCS M18	OCL M4	G-PLUS M36	Conf. pz.
Q8 R50 Guarnitura Q8 ros.50x7 senza bocc. <i>Lever handle Q8 on rose 50x7</i>	55442250501 35,90	55442250503 41,20	55442250507 41,20	55442250550 60,50	1
Q8 RB50 Guarnitura Q8 ros./bocc.50x7 patent <i>Lever handle Q8 on rose 50X7 -key escutcheon</i>	55442251501 40,40	55442251503 47,20	55442251507 47,20	55442251550 72,50	1
Q8 RBY50 Guarnitura Q8 ros./bocc. yale 50x7 <i>Lever handle Q8 on rose 50X7 - cyl escutcheon</i>	55442255501 40,40	55442255503 47,20	55442255507 47,20	55442255550 72,50	1
Q8 RBWC50 Guarnitura Q8 ros./bocc.Wc 50x7 <i>Lever handle Q8 on rose 50X7-WC function</i>	55442258501 48,60	55442258503 58,10	55442258507 58,10	55442258550 86,80	1
Q8 ROC Guarnitura Q8 ros.ovale senza bocc. <i>Lever handle Q8 on oval rose</i>	55442220501 39,40	55442220503 45,30	55442220507 45,30	55442220550 66,60	1
Q8 RBOC Guarnitura Q8 ros/bocc.ovale patent <i>Lever handle Q8 on oval rose-key escutcheon</i>	55442221501 44,40	55442221503 51,90	55442221507 51,90	55442221550 79,70	1
Q8 RBOYC Guarnitura Q8 ros/bocc.ovale Yale <i>Lever handle Q8 on oval rose-cyl escutcheon</i>	55442225501 44,40	55442225503 51,90	55442225507 51,90	55442225550 79,70	1
EZ IM Cremonese gioco EZ imp. maniglia <i>Window handle Q7 with mechanism-lever handle</i>	55442456001 54,70	55442456003 57,80	55442456007 57,80	55442456050 79,70	2
EZQ7 IM Cremonese gioco EZ + Q7 imp. maniglia <i>Window handle Q7 with mechanism-lever handle</i>	55442457001 55,10	55442457003 58,20	55442457007 58,20	55442457050 80,10	2
MART IM Martellina Q7 imp. maniglia <i>Window handle Q7 -lever handle</i>	55442550001 54,70	55442550003 57,80	55442550007 57,80	55442550050 79,70	2
DK x 40 Martellina DK Q7 x 40 <i>Window handle Q7 DK-tilt & turn handle</i>	55442557001 54,70	55442557003 57,80	55442557007 57,80	55442557050 79,70	2
DK x 40 C/BUSS. Martellina DK Q7 x 40 con bussole D. 9,5 <i>Window handle Q7 DK-tilt & turn handle with pins d.9,5</i>	55442558001 54,70	55442558003 57,80	55442558007 57,80	55442558050 79,70	2

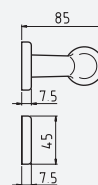
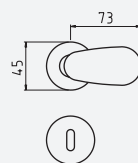

Ros 45x7		
		38-43

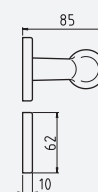
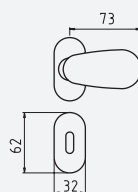

Ros 0006		
		38-43

GCTOL



GCTOS



F1-SAT

Per maggiori informazioni - For more information:

	GCTOL	GCTOS	F1-SAT	Conf. pz.
Q8 R	77450280012	77450280023	77450280033	
Guarnitura Q8 ros. senza bocc.				25
<i>Lever handle Q8 on rose</i>	35,20	37,30	37,30	
Q8 RB	77450281012	77450281023	77450281033	
Guarnitura Q8 ros./bocc. patent				25
<i>Lever handle Q8 on rose-key escutcheon</i>	39,30	42,70	42,70	
Q8 RBY	77450285012	77450285023	77450285033	
Guarnitura Q8 ros./bocc. Yale				25
<i>Lever handle Q8 on rose-cyl escutcheon</i>	39,30	42,70	42,70	
Q8 ROC	77450220512	77450220523	77450220533	
Guarnitura Q8 ros.ovale senza bocc.				25
<i>Lever handle Q8 on oval rose</i>	38,70	41,00	41,00	
Q8 RBOC	77450221512	77450221523	77450221533	
Guarnitura Q8 ros/bocc.ovale patent				25
<i>Lever handle Q8 on oval rose-key escutcheon</i>	43,30	47,00	47,00	
Q8 RBOYC	77450225512	77450225523	77450225533	
Guarnitura Q8 ros/bocc.ovale Yale				25
<i>Lever handle Q8 on oval rose-cyl escutcheon</i>	43,30	47,00	47,00	

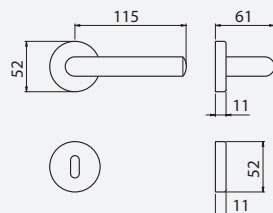
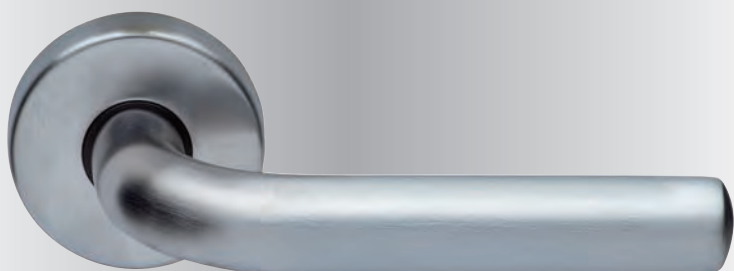

Ros 575		
38-43		
A richiesta / On request		
38	30	
50	50	

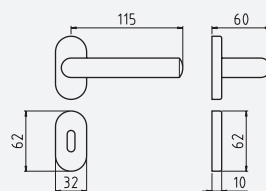

Ros 0006		
38-43		

OCS-M18



OLV-M1



OCL-M4

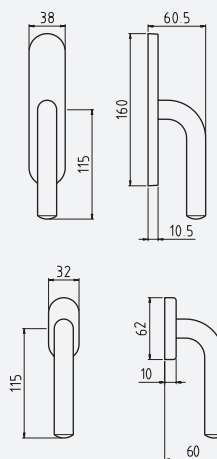

Per maggiori informazioni - For more information:

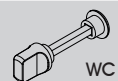

	OLV M1	OCS M18	OCL M4	Conf. pz.
Q8 R 52x10	55436280001	55436280003	55436280007	
Guarnitura Q8 ros. senza bocc.				1
<i>Lever handle Q8 on rose</i>	44,80	46,90	46,90	
Q8 RB 52x10	55436281001	55436281003	55436281007	
Guarnitura Q8 ros./bocc. patent				1
<i>Lever handle Q8 on rose-key escutcheon</i>	48,80	51,90	51,90	
Q8 RBY 52x10	55436285001	55436285003	55436285007	
Guarnitura Q8 ros./bocc. Yale				1
<i>Lever handle Q8 on rose-cyl escutcheon</i>	48,80	51,90	51,90	
Q8 RBWC 52x10	55436288001	55436288003	55436288007	
Guarnitura Q8 ros./bocc.Wc				1
<i>Lever handle Q8 on rose-WC function</i>	55,00	59,20	59,20	
Q8 ROC	55436220501	55436220503	55436220507	
Guarnitura Q8 ros.ovale senza bocc.				1
<i>Lever handle Q8 on oval rose</i>	43,60	50,00	50,00	
Q8 RBOC	55436221501	55436221503	55436221507	
Guarnitura Q8 ros/bocc.ovale patent				1
<i>Lever handle Q8 on oval rose-key escutcheon</i>	61,60	71,00	71,00	
Q8 RBOYC	55436225501	55436225503	55436225507	
Guarnitura Q8 ros/bocc.ovale Yale				1
<i>Lever handle Q8 on oval rose-cyl escutcheon</i>	61,60	71,00	71,00	
EZ IM	55436456001	55436456003	55436456007	
Cremonese gioco EZ imp. maniglia				2
<i>Window handle Q7 with mechanism-lever handle</i>	30,40	36,60	36,60	
EZQ7 IM	55436457001	55436457003	55436457007	
Cremonese gioco EZ + Q7 imp. maniglia				2
<i>Window handle Q7 with mechanism-lever handle</i>	30,80	37,00	37,00	
MART IM	55436550001	55436550003	55436550007	
Martellina Q7 imp. maniglia				2
<i>Window handle Q7-lever handle</i>	30,40	36,60	36,60	
DK x 40	55436557001	55436557003	55436557007	
Martellina DK Q7 x 40				2
<i>Window handle Q7 DK-tilt & turn handle</i>	30,40	36,60	36,60	

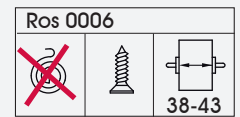
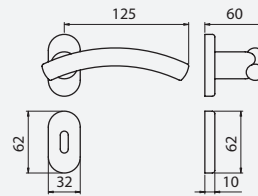
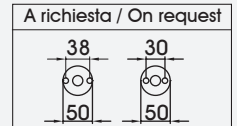
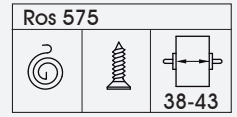
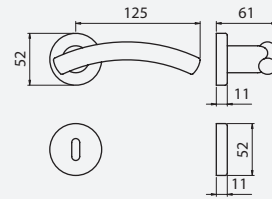
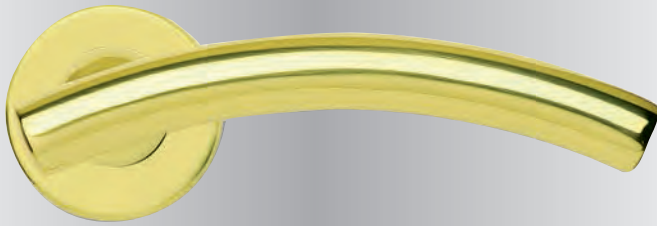

OLV-M1



OCS-M18



OCL-M4

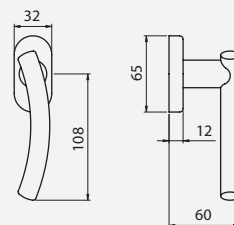
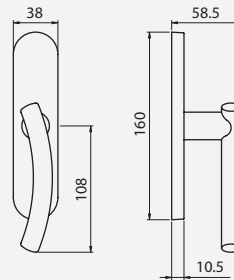

Per maggiori informazioni - For more information:

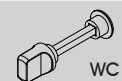

DISPONIBILE FINO AD ESAURIMENTO SCORTE

	OLV M1	OCS M18	OCL M4	Conf. pz.
Q8 R	55116280001	55116280003	55116280007	
Guarnitura Q8 ros. senza bocc.				1
<i>Lever handle Q8 on rose</i>	64,20	70,30	70,30	
Q8 RB	55116281001	55116281003	55116281007	
Guarnitura Q8 ros./bocc. patent				1
<i>Lever handle Q8 on rose-key escutcheon</i>	68,70	75,60	75,60	
Q8 RBY	55116285001	55116285003	55116285007	
Guarnitura Q8 ros./bocc. yale				1
<i>Lever handle Q8 on rose-cyl escutcheon</i>	68,70	75,60	75,60	
Q8 RBWC	55116288001	55116288003	55116288007	
Guarnitura Q8 ros./bocc.Wc				1
<i>Lever handle Q8 on rose-WC function</i>	73,60	83,20	83,20	
Q8 ROC	55116220501	55116220503	55116220507	
Guarnitura Q8 ros.ovale senza bocc.				1
<i>Lever handle Q8 on oval rose</i>	70,60	77,30	77,30	
Q8 RBOC	55116221501	55116221503	55116221507	
Guarnitura Q8 ros/bocc.ovale patent				1
<i>Lever handle Q8 on oval rose-key escutcheon</i>	75,60	83,20	83,20	
Q8 RBOYC	55116225501	55116225503	55116225507	
Guarnitura Q8 ros/bocc.ovale yale				1
<i>Lever handle Q8 on oval rose-cyl escutcheon</i>	75,60	83,20	83,20	
EZ IM	55116456001	55116456003	55116456007	
Cremonese gioco EZ imp. maniglia				2
<i>Window handle Q7 with mechanism-lever handle</i>	48,10	53,70	53,70	
EZQ7 IM	55116457001	55116457003	55116457007	
Cremonese gioco EZ + Q7 imp. maniglia				2
<i>Window handle Q7 with mechanism-lever handle</i>	48,50	54,10	54,10	
MART IM	55116550001	55116550003	55116550007	
Martellina Q7 imp. maniglia				2
<i>Window handle Q7-lever handle</i>	48,10	53,70	53,70	
DK x 40	55116557001	55116557003	55116557007	
Martellina DK Q7 x 40				2
<i>Window handle Q7 DK-tilt & turn handle</i>	48,10	53,70	53,70	
DK x 40 C/BUSS.	55116558001	55116558003	55116558007	
Martellina DK Q7 x 40 con bussole D. 9,5				2
<i>Window handle Q7 DK-tilt & turn handle with pins d.9,5</i>	48,10	53,70	53,70	



ZCS

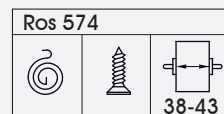
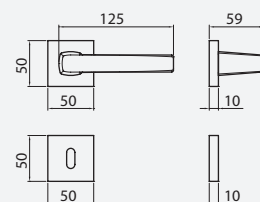
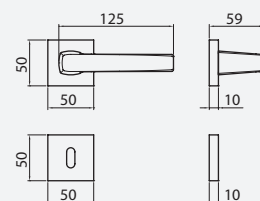

ZCL



GCTOL



ZNS

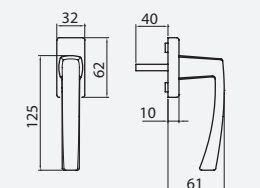
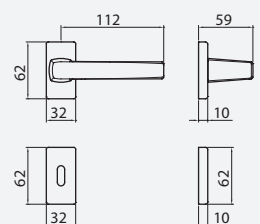

Per maggiori informazioni - For more information:

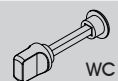

WC

	ZCL	GCTOL	ZCS	ZNS	Conf. pz.
Q8 RQ VL Guarnitura Q8 ros. senza bocc. con viti legno <i>Lever handle Q8 on rose with wood screw</i>	66470210307	66470210312	66470210313	66470210327	1
	22,25	21,75	22,25	22,75	
Q8 RBQ VL Guarnitura Q8 ros./bocc. Patent con viti legno <i>Lever handle Q8 on rose-key escutcheon with wood screw</i>	66470211307	66470211312	66470211313	66470211327	1
	26,95	26,05	26,95	27,45	
Q8 RBQ PZ VL Guarnitura Q8 ros./bocc. Yale con viti legno <i>Lever handle Q8 on rose-cyl escutcheon with wood screw</i>	66470215307	66470215312	66470215313	66470215327	1
	26,95	26,05	26,95	27,45	
Q8 RBQ WC Q6 VL Guarnitura Q8 ros./bocc. WC Q6 con viti legno <i>Lever handle Q8 on rose-WC Q6 function with wood screw</i>	66470218307	66470218312	66470218313	66470218327	1
	32,35	30,35	32,35	32,85	
Q8 RBQ WC Q8 VL Guarnitura Q8 ros./bocc. WC Q8 con viti legno <i>Lever handle Q8 on rose-WC Q8 function with wood screw</i>	66470218807	66470218812	66470218813	66470218827	1
	32,35	30,35	32,35	32,85	
Q8 RQ C/BUSS. VPA Guarnitura Q8 ros. senza bocc. con buss. viti passanti autofilettanti <i>Lever handle Q8 on rose with pins / thread forming screw</i>	6647021030700	6647021031200	6647021031300	6647021032700	1
	22,50	22,00	22,50	23,00	
Q8 RBQ C/BUSS. VPA Guarnitura Q8 ros./bocc. Patent con buss. viti passanti autofilettanti <i>Lever handle Q8 on rose-key escutcheon with pins / thread forming screw</i>	6647021130700	6647021131200	6647021131300	6647021132700	1
	27,20	26,30	27,20	27,70	
Q8 RBQ PZ C/BUSS. VPA Guarnitura Q8 ros./bocc. Yale con buss. viti passanti autofilettanti <i>Lever handle Q8 on rose-cyl escutcheon with pins / thread forming screw</i>	6647021530700	6647021531200	6647021531300	6647021532700	1
	27,20	26,30	27,20	27,70	
Q8 RBQ WC Q6 C/BUSS. VPA Guarnitura Q8 ros./bocc. WC Q6 con buss. viti passanti autofilettanti <i>Lever handle Q8 on rose-WC Q6 function with pins / thread forming screw</i>	6647021830700	6647021831200	6647021831300	6647021832700	1
	32,60	30,60	32,60	33,10	
Q8 RBQ WC Q8 C/BUSS. VPA Guarnitura Q8 ros./bocc. WC Q8 con buss. viti passanti autofilettanti <i>Lever handle Q8 on rose-WC Q8 function with pins / thread forming screw</i>	6647021880700	6647021881200	6647021881300	6647021882700	1
	32,60	30,60	32,60	33,10	
Q8 RRC VL Guarnitura Q8 ros. senza bocc. con viti legno <i>Lever handle Q8 on rose with wood screw</i>	66470210407	66470210412	66470210413	66470210427	1
	23,90	22,80	23,90	24,50	
Q8 RBRC VL Guarnitura Q8 ros./bocc. Patent con viti legno <i>Lever handle Q8 on rose-key escutcheon with wood screw</i>	66470211407	66470211412	66470211413	66470211427	1
	28,80	26,80	28,80	29,40	
Q8 RBRC PZ VL Guarnitura Q8 ros./bocc. Yale con viti legno <i>Lever handle Q8 on rose-cyl escutcheon with wood screw</i>	66470215407	66470215412	66470215413	66470215427	1
	28,80	26,80	28,80	29,40	
DK x 40 Martellina DK Q7 x 40 <i>Window handle Q7 DK-tilt & turn handle</i>	66470555007	66470555012	66470555013	66470555027	2
	10,70	10,20	10,70	10,50	
DK x 40 C/BUSS. Martellina DK Q7 x 40 con bussole D.9,5 mm <i>Window handle Q7 DK-tilt & turn handle with pins D.9,5 mm</i>	66470556007	66470556012	66470556013	66470556027	2
	10,70	10,20	10,70	10,50	

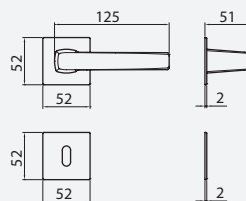

ZCS

Per maggiori informazioni - For more information:

	ZCL	GCTOL	ZCS	ZNS	Conf. pz.
Q8 RQ Guarnitura Q8 ros. senza bocc. <i>Lever handle Q8 on rose</i>	66470210607	66470210612	66470210613	66470210627	1
	20,30	20,20	20,30	21,10	
Q8 RBQ Guarnitura Q8 ros./bocc. Patent <i>Lever handle Q8 on rose-key escutcheon</i>	66470211607	66470211612	66470211613	66470211627	1
	24,40	24,20	24,40	25,00	
Q8 RBQ PZ Guarnitura Q8 ros./bocc. Yale <i>Lever handle Q8 on rose-cyl escutcheon</i>	66470215607	66470215612	66470215613	66470215627	1
	24,40	24,20	24,40	25,00	
Q8 RBQ WC Q6 Guarnitura Q8 ros./bocc. WC Q6 <i>Lever handle Q8 on rose-WC Q6 function</i>	66470218607	66470218612	66470218613	66470218627	1
	29,80	29,20	29,80	30,30	
Q8 RBQ WC Q8 Guarnitura Q8 ros./bocc. WC Q8 <i>Lever handle Q8 on rose-WC Q8 function</i>	66470218907	66470218912	66470218913	66470218927	1
	29,80	29,20	29,80	30,30	



ZCL

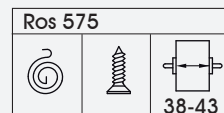
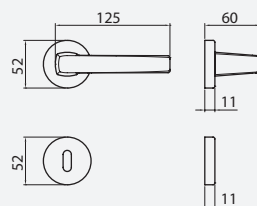
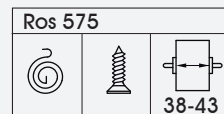
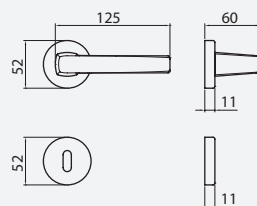

GCTOL



ZCS



ZNS

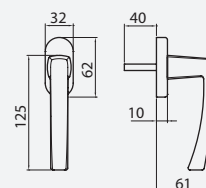
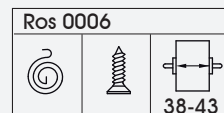
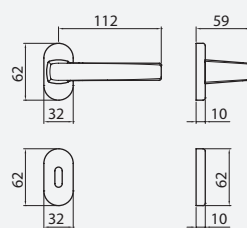

Per maggiori informazioni - For more information:

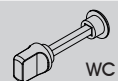

	ZCL	GCTOL	ZCS	ZNS	Conf. pz.
Q8 R VL Guarnitura Q8 ros. senza bocc. con viti legno <i>Lever handle Q8 on rose with wood screw</i>	66470280907	66470280912	66470280913	66470280927	1
	28,05	27,25	28,05	29,15	
Q8 RB VL Guarnitura Q8 ros./bocc. Patent con viti legno <i>Lever handle Q8 on rose-key escutcheon with wood screw</i>	66470281907	66470281912	66470281913	66470281927	1
	32,15	30,45	32,15	33,55	
Q8 RB PZ VL Guarnitura Q8 ros./bocc. Yale con viti legno <i>Lever handle Q8 on rose-cyl escutcheon with wood screw</i>	66470285907	66470285912	66470285913	66470285927	1
	32,15	30,45	32,15	33,55	
Q8 RB WC Q6 VL Guarnitura Q8 ros./bocc. WC Q6 con viti legno <i>Lever handle Q8 on rose-WC Q6 function with wood screw</i>	66470288907	66470288912	66470288913	66470288927	1
	39,05	36,05	39,05	40,35	
Q8 RB WC Q8 VL Guarnitura Q8 ros./bocc. WC Q8 con viti legno <i>Lever handle Q8 on rose-WC Q8 function with wood screw</i>	66470288507	66470288512	66470288513	66470288527	1
	39,05	36,05	39,05	40,35	
Q8 R C/BUSS. VPA Guarnitura Q8 ros. senza bocc. con buss. viti passanti autofilettanti <i>Lever handle Q8 on rose with pins / thread forming screw</i>	6647028090700	6647028091200	6647028091300	6647028092700	1
	28,30	27,50	28,30	29,40	
Q8 RB C/BUSS. VPA Guarnitura Q8 ros./bocc. Patent con buss. viti passanti autofilettanti <i>Lever handle Q8 on rose-key escutcheon with pins / thread forming screw</i>	6647028190700	6647028191200	6647028191300	6647028192700	1
	32,40	30,70	32,40	33,80	
Q8 RB PZ C/BUSS. VPA Guarnitura Q8 ros./bocc. Yale con buss. viti passanti autofilettanti <i>Lever handle Q8 on rose-cyl escutcheon with pins / thread forming screw</i>	6647028590700	6647028591200	6647028591300	6647028592700	1
	32,40	30,70	32,40	33,80	
Q8 RBQ WC Q6 C/BUSS. VPA Guarnitura Q8 ros./bocc. WC Q6 con buss. viti passanti autofilettanti <i>Lever handle Q8 on rose-WC Q6 function with pins / thread forming screw</i>	6647028890700	6647028891200	6647028891300	6647028892700	1
	39,30	36,30	39,30	40,60	
Q8 RB WC Q8 C/BUSS. VPA Guarnitura Q8 ros./bocc. WC Q8 con buss. viti passanti autofilettanti <i>Lever handle Q8 on rose-WC Q8 function with pins / thread forming screw</i>	6647028850700	6647028851200	6647028851300	6647028852700	1
	39,30	36,30	39,30	40,60	
Q8 ROC VL Guarnitura Q8 ros. senza bocc. con viti legno <i>Lever handle Q8 on rose with wood screw</i>	66470220607	66470220612	66470220613	66470220627	1
	30,80	29,90	30,80	31,50	
Q8 RBOC VL Guarnitura Q8 ros./bocc. Patent con viti legno <i>Lever handle Q8 on rose-key escutcheon with wood screw</i>	66470221607	66470221612	66470221613	66470221627	1
	35,50	34,10	35,50	36,50	
Q8 RBOC PZ VL Guarnitura Q8 ros./bocc. Yale con viti legno <i>Lever handle Q8 on rose-cyl escutcheon with wood screw</i>	66470225607	66470225612	66470225613	66470225627	1
	35,50	34,10	35,50	36,50	
DK x 40 Martellina DK Q7 x 40 <i>Window handle Q7 DK-tilt & turn handle</i>	66470557007	66470557012	66470557013	66470557027	2
	13,50	13,90	13,50	13,90	
DK x 40 C/BUSS. Martellina DK Q7 x 40 con bussole D.9,5 mm <i>Window handle Q7 DK-tilt & turn handle with pins D.9,5 mm</i>	66470558007	66470558012	66470558013	66470558027	2
	13,50	13,90	13,50	13,90	



OCL/EB-E4

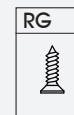
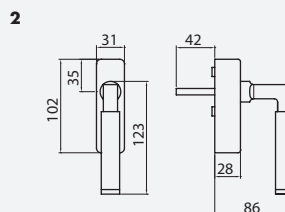
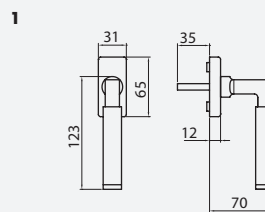
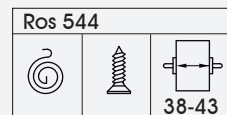
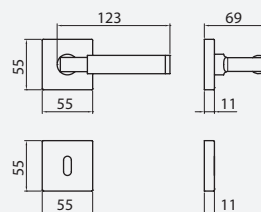
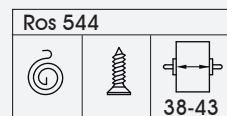
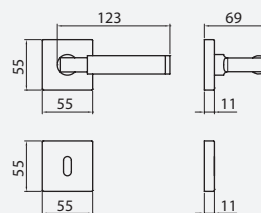

Per maggiori informazioni - For more information:

Rosette da pag. 246 a pag. 257 Roses from pag. 246 to pag. 257
 Placche da pag. 265 a pag. 267 Plates from pag. 265 to pag. 267
 DK da pag. 262 a pag. 264 Window handles from pag. 262 to pag. 264

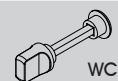

	OCL / EB E4	Conf. pz.
966/544 Q8 RQ VL Guarnitura Q8 ros. senza bocc. con viti legno <i>Lever handle Q8 on rose with wood screw</i>	R0966054405E760 76,55	1
966/544 Q8 RBQ BB VL Guarnitura Q8 ros./bocc. BB con viti legno <i>Lever handle Q8 on rose-key escutcheon with wood screw</i>	R0966054410E760 87,35	1
966/544 Q8 RBQ PZ VL Guarnitura Q8 ros./bocc. Yale con viti legno <i>Lever handle Q8 on rose-cyl escutcheon with wood screw</i>	R0966054450E760 87,35	1
966/544 Q8 RBQ WC Q8 VL Guarnitura Q8 ros./bocc. WC Q8 con viti legno <i>Lever handle Q8 on rose-WC Q8 function with wood screw</i>	R0966054488E760 94,75	1
966/544 Q8 RQ C/BUSS. VPM Guarnitura Q8 ros. senza bocc. con buss. viti passanti metriche <i>Lever handle Q8 on rose with pins / metric-thread screw</i>	R0966054405E740 76,80	1
966/544 Q8 RBQ BB C/BUSS. VPM Guarnitura Q8 ros./bocc. BB con buss. viti passanti metriche <i>Lever handle Q8 on rose-key escutcheon with pins / metric-thread screw</i>	R0966054410E740 87,60	1
966/544 Q8 RBQ PZ C/BUSS. VPM Guarnitura Q8 ros./bocc. Yale con buss. viti passanti metriche <i>Lever handle Q8 on rose-cyl escutcheon with pins / metric-thread screw</i>	R0966054450E740 87,60	1
966/544 Q8 RBQ WC Q8 C/BUSS. VPM Guarnitura Q8 ros./bocc. WC Q8 con buss. viti passanti metriche <i>Lever handle Q8 on rose-WC Q8 function with pins / metric-thread screw</i>	R0966054488E740 95,00	1
966/00C4 DK x 35 VM C/BUSS.	R096600C480E790	
1 Martellina DK Q7 x 35 con bussole D.9,5 mm viti metriche <i>Window handle Q7 DK-tilt & turn handle with pins D.9,5 / metric-thread screw</i>	36,80	1
966/00A4 DK x 42 C/CHIAVE VM C/BUSS.	R096600A484E790	
2 Martellina con chiave DK Q7 x 42 con bussole D.9,5 mm viti metriche <i>Window handle Q7 DK-tilt & turn handle with key with pins D.9,5 / metric-thread screw</i>	93,20	1



OCL-M4

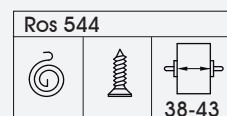
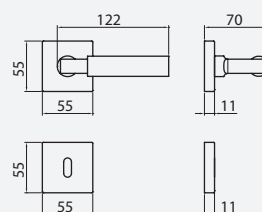
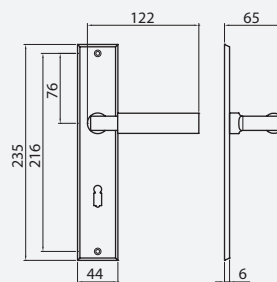

OCS-M18



ONS-M9

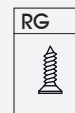
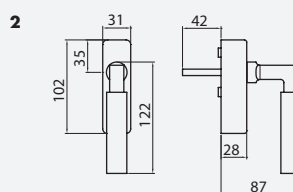
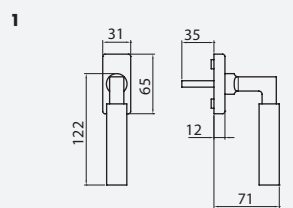
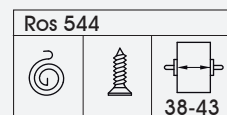
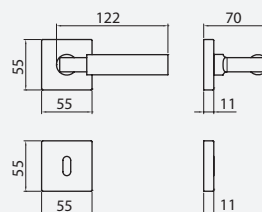

Per maggiori informazioni - For more information:

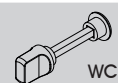

	OCS M18	OCL M4	ONS M9	Conf. pz.
988/836 Q8 BB72 VL Guarnitura Q8 placca BB 72 con viti legno <i>Lever handle Q8 on key plate 72 with wood screw</i>	R098808367303	R098808367307	R098808367327	1
	85,60	85,60	88,80	
988/836 Q8 PZ72 VL Guarnitura Q8 placca Yale 72 con viti legno <i>Lever handle Q8 on cyl. plate 72 with wood screw</i>	R098808367703	R098808367707	R098808367727	1
	85,60	85,60	88,80	
988/836 Q8 WC78 Q8 VL Guarnitura Q8 placca WC 78 Q8 viti legno <i>Lever handle Q8 on WC Q8 function plate 78 with wood screw</i>	R098808369803	R098808369807	R098808369827	1
	96,30	96,30	100,10	
988/544 Q8 RQ VL Guarnitura Q8 ros. senza bocc. con viti legno <i>Lever handle Q8 on rose with wood screw</i>	R09880544050360	R09880544050760	R09880544052760	1
	70,85	70,85	73,15	
988/544 Q8 RBQ BB VL Guarnitura Q8 ros./bocc. BB con viti legno <i>Lever handle Q8 on rose-key escutcheon with wood screw</i>	R09880544100360	R09880544100760	R09880544102760	1
	81,35	81,35	84,05	
988/544 Q8 RBQ PZ VL Guarnitura Q8 ros./bocc. Yale con viti legno <i>Lever handle Q8 on rose-cyl escutcheon with wood screw</i>	R09880544500360	R09880544500760	R09880544502760	1
	81,35	81,35	84,05	
988/544 Q8 RBQ WC Q8 VL Guarnitura Q8 ros./bocc. WC Q8 con viti legno <i>Lever handle Q8 on rose-WC Q8 function with wood screw</i>	R09880544880360	R09880544880760	R09880544882760	1
	88,35	88,35	91,45	
988/544 Q8 RQ C/BUSS. VPM Guarnitura Q8 ros. senza bocc. con buss. viti passanti metriche <i>Lever handle Q8 on rose with pins / metric-thread screw</i>	R09880544050340	R09880544050740	R09880544052740	1
	71,10	71,10	73,40	
988/544 Q8 RBQ BB C/BUSS. VPM Guarnitura Q8 ros./bocc. BB con buss. viti passanti metriche <i>Lever handle Q8 on rose-key escutcheon with pins / metric-thread screw</i>	R09880544100340	R09880544100740	R09880544102740	1
	81,60	81,60	84,30	
988/544 Q8 RBQ PZ C/BUSS. VPM Guarnitura Q8 ros./bocc. Yale con buss. viti passanti metriche <i>Lever handle Q8 on rose-cyl escutcheon with pins / metric-thread screw</i>	R09880544500340	R09880544500740	R09880544502740	1
	81,60	81,60	84,30	
988/544 Q8 RBQ WC Q8 C/BUSS. VPM Guarnitura Q8 ros./bocc. WC Q8 con buss. viti passanti metriche <i>Lever handle Q8 on rose-WC Q8 function with pins / metric-thread screw</i>	R09880544880340	R09880544880740	R09880544882740	1
	88,60	88,60	91,70	
988/00C4 DK x 35 VM C/BUSS. 1 Martellina DK Q7 x 35 con bussole D.9,5 mm viti metriche <i>Window handle Q7 DK-tilt & turn handle with pins D.9,5 / metric-thread screw</i>	R098800C4800390	R098800C4800790	R098800C4802790	1
	35,30	35,30	36,60	
988/00A4 DK x 42 C/CHIAVE VM C/BUSS. 2 Martellina con chiave DK Q7 x 42 con bussole D.9,5 mm viti metriche <i>Window handle Q7 DK-tilt & turn handle with key with pins D.9,5 / metric-thread screw</i>	R098800A4840390	R098800A4840790	R098800A4842790	1
	87,40	87,40	90,90	



ONL-M7

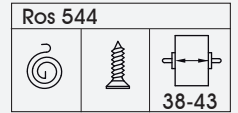
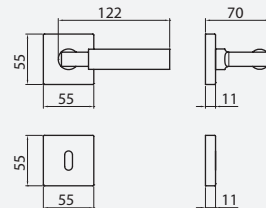
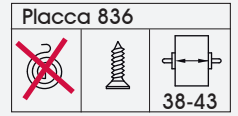
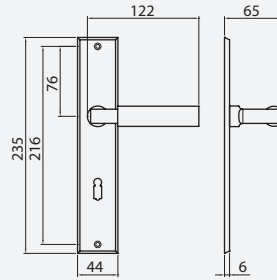

OCL/EB-E4



ONL/EB-E7

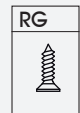
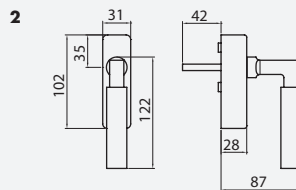
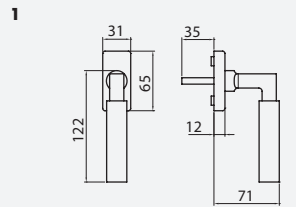
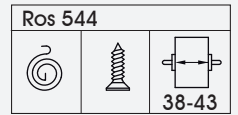
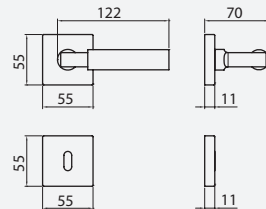

Per maggiori informazioni - For more information:

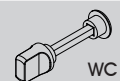

	ONL M7	OCL / EB E4	ONL / EB E7	Conf. pz.
988/836 Q8 BB72 VL Guarnitura Q8 placca BB 72 con viti legno <i>Lever handle Q8 on key plate 72 with wood screw</i>	R098808367330 85,60	R0988083673E7 89,50	R0988083673EN 89,50	1
988/836 Q8 PZ72 VL Guarnitura Q8 placca Yale 72 con viti legno <i>Lever handle Q8 on cyl. plate 72 with wood screw</i>	R098808367730 85,60	R0988083677E7 89,50	R0988083677EN 89,50	1
988/836 Q8 WC78 Q8 VL Guarnitura Q8 placca WC 78 Q8 viti legno <i>Lever handle Q8 on WC Q8 function plate 78 with wood screw</i>	R098808369830 96,30	R0988083698E7 100,20	R0988083698EN 100,20	1
988/544 Q8 RQ VL Guarnitura Q8 ros. senza bocc. con viti legno <i>Lever handle Q8 on rose with wood screw</i>	R09880544053060 70,85	R0988054405E760 75,75	R0988054405EN60 75,75	1
988/544 Q8 RBQ BB VL Guarnitura Q8 ros./bocc. BB con viti legno <i>Lever handle Q8 on rose-key escutcheon with wood screw</i>	R09880544103060 81,35	R0988054410E760 86,95	R0988054410EN60 86,95	1
988/544 Q8 RBQ PZ VL Guarnitura Q8 ros./bocc. Yale con viti legno <i>Lever handle Q8 on rose-cyl escutcheon with wood screw</i>	R09880544503060 81,35	R0988054450E760 86,95	R0988054450EN60 86,95	1
988/544 Q8 RBQ WC Q8 VL Guarnitura Q8 ros./bocc. WC Q8 con viti legno <i>Lever handle Q8 on rose-WC Q8 function with wood screw</i>	R09880544883060 88,35	R0988054488E760 94,65	R0988054488EN60 94,65	1
988/544 Q8 RQ C/BUSS. VPM Guarnitura Q8 ros. senza bocc. con buss. viti passanti metriche <i>Lever handle Q8 on rose with pins / metric-thread screw</i>	R09880544053040 71,10	R0988054405E740 76,00	R0988054405EN40 76,00	1
988/544 Q8 RBQ BB C/BUSS. VPM Guarnitura Q8 ros./bocc. BB con buss. viti passanti metriche <i>Lever handle Q8 on rose-key escutcheon with pins / metric-thread screw</i>	R09880544103040 81,60	R0988054410E740 87,20	R0988054410EN40 87,20	1
988/544 Q8 RBQ PZ C/BUSS. VPM Guarnitura Q8 ros./bocc. Yale con buss. viti passanti metriche <i>Lever handle Q8 on rose-cyl escutcheon with pins / metric-thread screw</i>	R09880544503040 81,60	R0988054450E740 87,20	R0988054450EN40 87,20	1
988/544 Q8 RBQ WC Q8 C/BUSS. VPM Guarnitura Q8 ros./bocc. WC Q8 con buss. viti passanti metriche <i>Lever handle Q8 on rose-WC Q8 function with pins / metric-thread screw</i>	R09880544883040 88,60	R0988054488E740 94,90	R0988054488EN40 94,90	1
988/00C4 DK x 35 VM C/BUSS. 1 Martellina DK Q7 x 35 con bussole D.9,5 mm viti metriche <i>Window handle Q7 DK-tilt & turn handle with pins D.9,5 / metric-thread screw</i>	R098800C4803090 35,30	R098800C480E790 36,30	R098800C480EN90 36,50	1
988/00A4 DK x 42 C/CHIAVE VM C/BUSS. 2 Martellina con chiave DK Q7 x 42 con bussole D.9,5 mm viti metriche <i>Window handle Q7 DK-tilt & turn handle with key with pins D.9,5 / metric-thread screw</i>	R098800A4843090 87,40	R098800A484E790 88,80	R098800A484EN90 88,80	1



OCS-M18

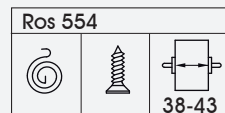
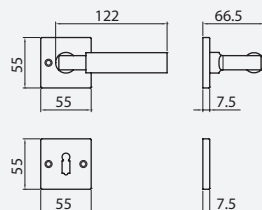

OCL-M4



ONS-M9



ONL-M7



OCL/EB-E4



ONL/EB-E7

Per maggiori informazioni - For more information:

Rosette da pag. 246 a pag. 257
 Placche da pag. 265 a pag. 267
 DK da pag. 262 a pag. 264

Roses from pag. 246 to pag. 257
 Plates from pag. 265 to pag. 267
 Window handles from pag. 262 to pag. 264

	OCS M18	OCL M4	ONS M9	Conf. pz.
988/554 Q8 RQ VV C/BUSS. VPM Guarnitura Q8 ros. senza bocc. con buss. viti passanti metriche <i>Lever handle Q8 on rose with pins / metric-thread screw</i>	R09880554050340 72,50	R09880554050740 72,50	R09880554052740 71,00	1
988/554 Q8 RBQ BB VV C/BUSS. VPM Guarnitura Q8 ros./bocc. BB con buss. viti passanti metriche <i>Lever handle Q8 on rose-key escutcheon with pins / metric-thread screw</i>	R09880554120340 80,70	R09880554120740 80,70	R09880554122740 79,90	1
988/554 Q8 RBQ PZ VV C/BUSS. VPM Guarnitura Q8 ros./bocc. Yale con buss. viti passanti metriche <i>Lever handle Q8 on rose-cyl escutcheon with pins / metric-thread screw</i>	R09880554500340 80,70	R09880554500740 80,70	R09880554502740 79,90	1
988/554 Q8 RBQ WC Q8 VV C/BUSS. VPM Guarnitura Q8 ros./bocc. WC Q8 con buss. viti passanti metriche <i>Lever handle Q8 on rose-WC Q8 function with pins / metric-thread screw</i>	R09880554880340 88,40	R09880554880740 88,40	R09880554882740 87,30	1

	ONL M7	OCL / EB E4	ONL / EB E7	Conf. pz.
988/554 Q8 RQ VV C/BUSS. VPM Guarnitura Q8 ros. senza bocc. con buss. viti passanti metriche <i>Lever handle Q8 on rose with pins / metric-thread screw</i>	R09880554053040 72,50	R0988055405E740 73,60	R0988055405EN40 73,60	1
988/554 Q8 RBQ BB VV C/BUSS. VPM Guarnitura Q8 ros./bocc. BB con buss. viti passanti metriche <i>Lever handle Q8 on rose-key escutcheon with pins / metric-thread screw</i>	R09880554123040 80,70	R0988055412E740 83,30	R0988055412EN40 83,30	1
988/554 Q8 RBQ PZ VV C/BUSS. VPM Guarnitura Q8 ros./bocc. Yale con buss. viti passanti metriche <i>Lever handle Q8 on rose-cyl escutcheon with pins / metric-thread screw</i>	R09880554503040 80,70	R0988055450E740 83,30	R0988055450EN40 83,30	1
988/554 Q8 RBQ WC Q8 VV C/BUSS. VPM Guarnitura Q8 ros./bocc. WC Q8 con buss. viti passanti metriche <i>Lever handle Q8 on rose-WC Q8 function with pins / metric-thread screw</i>	R09880554883040 88,40	R0988055488E740 91,00	R0988055488EN40 91,00	1



ZCS

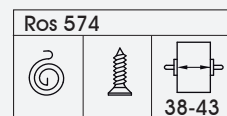
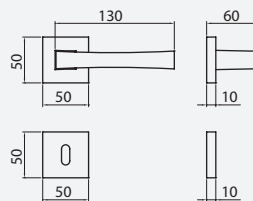
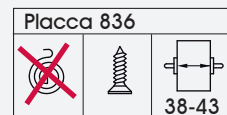
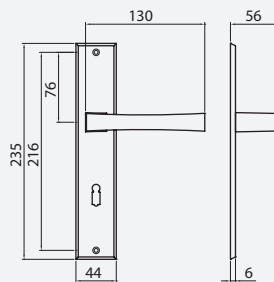

ZCL



ZNS

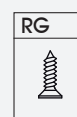
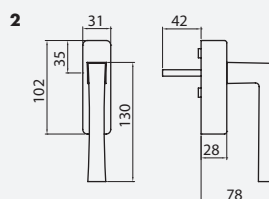
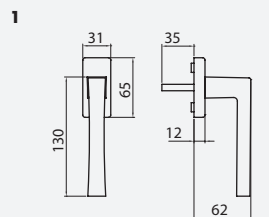
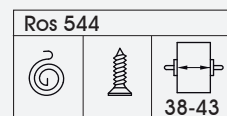
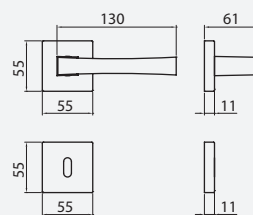

Per maggiori informazioni - For more information:

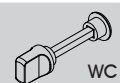

	ZCL	ZCS	ZNS	Conf. pz.
996/836 Q8 BB72 VL Guarnitura Q8 placca BB 72 con viti legno <i>Lever handle Q8 on key plate 72 with wood screw</i>	R099608367307 48,80	R099608367313 48,80	R099608367327 50,50	1
996/836 Q8 PZ72 VL Guarnitura Q8 placca Yale 72 con viti legno <i>Lever handle Q8 on cyl. plate 72 with wood screw</i>	R099608367707 48,80	R099608367713 48,80	R099608367727 50,50	1
996/836 Q8 WC78 Q8 VL Guarnitura Q8 placca WC 78 Q8 viti legno <i>Lever handle Q8 on WC Q8 function plate 78 with wood screw</i>	R099608369807 56,10	R099608369813 56,10	R099608369827 57,80	1
996/574 Q8 RQ VL Guarnitura Q8 ros. senza bocc. con viti legno <i>Lever handle Q8 on rose with wood screw</i>	R09960574050760 32,85	R09960574051360 32,85	R09960574052760 32,95	1
996/574 Q8 RBQ BB VL Guarnitura Q8 ros./bocc. BB con viti legno <i>Lever handle Q8 on rose-key escutcheon with wood screw</i>	R09960574100760 39,25	R09960574101360 39,25	R09960574102760 39,45	1
996/574 Q8 RBQ PZ VL Guarnitura Q8 ros./bocc. Yale con viti legno <i>Lever handle Q8 on rose-cyl escutcheon with wood screw</i>	R09960574500760 39,25	R09960574501360 39,25	R09960574502760 39,45	1
996/574 Q8 RBQ WC Q8 VL Guarnitura Q8 ros./bocc. WC Q8 con viti legno <i>Lever handle Q8 on rose-WC Q8 function with wood screw</i>	R09960574880760 46,65	R09960574881360 46,65	R09960574882760 46,85	1
996/574 Q8 RQ C/BUSS. VPA Guarnitura Q8 ros. senza bocc. con buss. viti passanti autofilettanti <i>Lever handle Q8 on rose with pins / thread forming screw</i>	R099605740507 33,10	R099605740513 33,10	R099605740527 33,20	1
996/574 Q8 RBQ BB C/BUSS. VPA Guarnitura Q8 ros./bocc. BB con buss. viti passanti autofilettanti <i>Lever handle Q8 on rose-key escutcheon with pins / thread forming screw</i>	R099605741007 39,50	R099605741013 39,50	R099605741027 39,70	1
996/574 Q8 RBQ PZ C/BUSS. VPA Guarnitura Q8 ros./bocc. Yale con buss. viti passanti autofilettanti <i>Lever handle Q8 on rose-cyl escutcheon with pins / thread forming screw</i>	R099605745007 39,50	R099605745013 39,50	R099605745027 39,70	1
996/574 Q8 RBQ WC Q8 C/BUSS. VPA Guarnitura Q8 ros./bocc. WC Q8 con buss. viti passanti autofilettanti <i>Lever handle Q8 on rose-WC Q8 function with pins / thread forming screw</i>	R099605748807 46,90	R099605748813 46,90	R099605748827 47,10	1
996/544 Q8 RQ VL Guarnitura Q8 ros. senza bocc. con viti legno <i>Lever handle Q8 on rose with wood screw</i>	R09960544050760 35,45	R09960544051360 35,45	R09960544052760 35,75	1
996/544 Q8 RBQ BB VL Guarnitura Q8 ros./bocc. BB con viti legno <i>Lever handle Q8 on rose-key escutcheon with wood screw</i>	R09960544100760 46,15	R09960544101360 46,15	R09960544102760 46,65	1
996/544 Q8 RBQ PZ VL Guarnitura Q8 ros./bocc. Yale con viti legno <i>Lever handle Q8 on rose-cyl escutcheon with wood screw</i>	R09960544500760 46,15	R09960544501360 46,15	R09960544502760 46,65	1
996/544 Q8 RBQ WC Q8 VL Guarnitura Q8 ros./bocc. WC Q8 con viti legno <i>Lever handle Q8 on rose-WC Q8 function with wood screw</i>	R09960544880760 53,55	R09960544881360 53,55	R09960544882760 54,05	1
996/544 Q8 RQ C/BUSS. VPM Guarnitura Q8 ros. senza bocc. con buss. viti passanti metriche <i>Lever handle Q8 on rose with pins / metric-thread screw</i>	R09960544050740 35,70	R09960544051340 35,70	R09960544052740 36,00	1
996/544 Q8 RBQ BB C/BUSS. VPM Guarnitura Q8 ros./bocc. BB con buss. viti passanti metriche <i>Lever handle Q8 on rose-key escutcheon with pins / metric-thread screw</i>	R09960544100740 46,40	R09960544101340 46,40	R09960544102740 46,90	1
996/544 Q8 RBQ PZ C/BUSS. VPM Guarnitura Q8 ros./bocc. Yale con buss. viti passanti metriche <i>Lever handle Q8 on rose-cyl escutcheon with pins / metric-thread screw</i>	R09960544500740 46,40	R09960544501340 46,40	R09960544502740 46,90	1
996/544 Q8 RBQ WC Q8 C/BUSS. VPM Guarnitura Q8 ros./bocc. WC Q8 con buss. viti passanti metriche <i>Lever handle Q8 on rose-WC Q8 function with pins / metric-thread screw</i>	R09960544880740 53,80	R09960544881340 53,80	R09960544882740 54,30	1
996/00C4 DK x 35 VM C/BUSS. 1 Martellina DK Q7 x 35 con bussole D.9,5 mm viti metriche <i>Window handle Q7 DK-tilt & turn handle with pins D.9,5 / metric-thread screw</i>	R099600C48007 17,60	R099600C48013 17,60	R099600C48027 18,15	2
996/00A4 DK x 42 C/CHIAVE VM C/BUSS. 2 Martellina con chiave DK Q7 x 42 con bussole D.9,5 mm viti metriche <i>Window handle Q7 DK-tilt & turn handle with key with pins D.9,5 / metric-thread screw</i>	R099600A4840790 70,30	R099600A4841390 70,30	R099600A4842790 72,40	1



ZCS

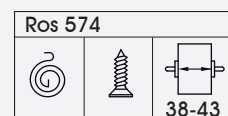
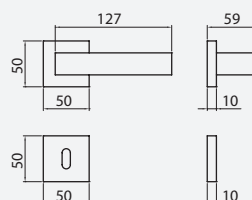
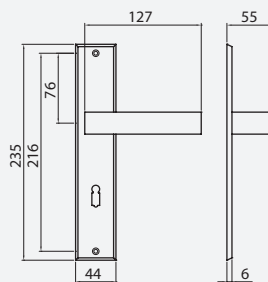

ZCL



ZNS

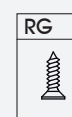
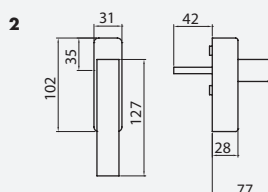
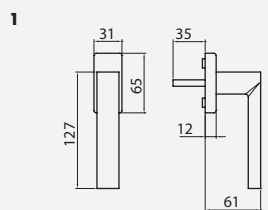
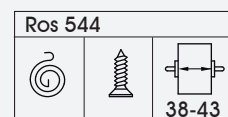
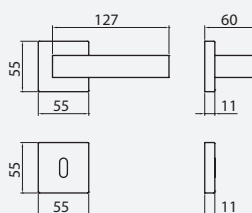

Per maggiori informazioni - For more information:

Rosette da pag. 246 a pag. 257
 Placche da pag. 265 a pag. 267
 DK da pag. 262 a pag. 264

Roses from pag. 246 to pag. 257
 Plates from pag. 265 to pag. 267
 Window handles from pag. 262 to pag. 264

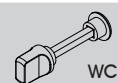

	ZCL	ZCS	ZNS	Conf. pz.
997/836 Q8 BB72 VL Guarnitura Q8 placca BB 72 con viti legno <i>Lever handle Q8 on key plate 72 with wood screw</i>	R099708367307	R099708367313	R099708367327	1
	50,10	50,10	51,80	
997/836 Q8 PZ72 VL Guarnitura Q8 placca Yale 72 con viti legno <i>Lever handle Q8 on cyl. plate 72 with wood screw</i>	R099708367707	R099708367713	R099708367727	1
	50,10	50,10	51,80	
997/836 Q8 WC78 Q8 VL Guarnitura Q8 placca WC 78 Q8 viti legno <i>Lever handle Q8 on WC Q8 function plate 78 with wood screw</i>	R099708369807	R099708369813	R099708369827	1
	57,50	57,50	59,20	
997/574 Q8 RQ VL Guarnitura Q8 ros. senza bocc. con viti legno <i>Lever handle Q8 on rose with wood screw</i>	R09970574050760	R09970574051360	R09970574052760	1
	34,05	34,05	34,15	
997/574 Q8 RBQ BB VL Guarnitura Q8 ros./bocc. BB con viti legno <i>Lever handle Q8 on rose-key escutcheon with wood screw</i>	R09970574100760	R09970574101360	R09970574102760	1
	40,65	40,65	40,75	
997/574 Q8 RBQ PZ VL Guarnitura Q8 ros./bocc. Yale con viti legno <i>Lever handle Q8 on rose-cyl escutcheon with wood screw</i>	R09970574500760	R09970574501360	R09970574502760	1
	40,65	40,65	40,75	
997/574 Q8 RBQ WC Q8 VL Guarnitura Q8 ros./bocc. WC Q8 con viti legno <i>Lever handle Q8 on rose-WC Q8 function with wood screw</i>	R09970574880760	R09970574881360	R09970574882760	1
	47,95	47,95	48,05	
997/574 Q8 RQ C/BUSS. VPA Guarnitura Q8 ros. senza bocc. con buss. viti passanti autofilettanti <i>Lever handle Q8 on rose with pins / thread forming screw</i>	R099705740507	R099705740513	R099705740527	1
	34,30	34,30	34,40	
997/574 Q8 RBQ BB C/BUSS. VPA Guarnitura Q8 ros./bocc. BB con buss. viti passanti autofilettanti <i>Lever handle Q8 on rose-key escutcheon with pins / thread forming screw</i>	R099705741007	R099705741013	R099705741027	1
	40,90	40,90	41,00	
997/574 Q8 RBQ PZ C/BUSS. VPA Guarnitura Q8 ros./bocc. Yale con buss. viti passanti autofilettanti <i>Lever handle Q8 on rose-cyl escutcheon with pins / thread forming screw</i>	R099705745007	R099705745013	R099705745027	1
	40,90	40,90	41,00	
997/574 Q8 RBQ WC Q8 C/BUSS. VPA Guarnitura Q8 ros./bocc. WC Q8 con buss. viti passanti autofilettanti <i>Lever handle Q8 on rose-WC Q8 function with pins / thread forming screw</i>	R099705748807	R099705748813	R099705748827	1
	48,20	48,20	48,30	
997/544 Q8 RQ VL Guarnitura Q8 ros. senza bocc. con viti legno <i>Lever handle Q8 on rose with wood screw</i>	R09970544050760	R09970544051360	R09970544052760	1
	36,65	36,65	38,15	
997/544 Q8 RBQ BB VL Guarnitura Q8 ros./bocc. BB con viti legno <i>Lever handle Q8 on rose-key escutcheon with wood screw</i>	R09970544100760	R09970544101360	R09970544102760	1
	47,05	47,05	48,95	
997/544 Q8 RBQ PZ VL Guarnitura Q8 ros./bocc. Yale con viti legno <i>Lever handle Q8 on rose-cyl escutcheon with wood screw</i>	R09970544500760	R09970544501360	R09970544502760	1
	47,05	47,05	48,95	
997/544 Q8 RBQ WC Q8 VL Guarnitura Q8 ros./bocc. WC Q8 con viti legno <i>Lever handle Q8 on rose-WC Q8 function with wood screw</i>	R09970544880760	R09970544881360	R09970544882760	1
	54,25	54,25	56,45	
997/544 Q8 RQ C/BUSS. VPM Guarnitura Q8 ros. senza bocc. con buss. viti passanti metriche <i>Lever handle Q8 on rose with pins / metric-thread screw</i>	R09970544050740	R09970544051340	R09970544052740	1
	36,90	36,90	38,40	
997/544 Q8 RBQ BB C/BUSS. VPM Guarnitura Q8 ros./bocc. BB con buss. viti passanti metriche <i>Lever handle Q8 on rose-key escutcheon with pins / metric-thread screw</i>	R09970544100740	R09970544101340	R09970544102740	1
	47,30	47,30	49,20	
997/544 Q8 RBQ PZ C/BUSS. VPM Guarnitura Q8 ros./bocc. Yale con buss. viti passanti metriche <i>Lever handle Q8 on rose-cyl escutcheon with pins / metric-thread screw</i>	R09970544500740	R09970544501340	R09970544502740	1
	47,30	47,30	49,20	
997/544 Q8 RBQ WC Q8 C/BUSS. VPM Guarnitura Q8 ros./bocc. WC Q8 con buss. viti passanti metriche <i>Lever handle Q8 on rose-WC Q8 function with pins / metric-thread screw</i>	R09970544880740	R09970544881340	R09970544882740	1
	54,50	54,50	56,70	
997/00C4 DK x 35 VM C/BUSS. 1 Martellina DK Q7 x 35 con bussole D.9,5 mm viti metriche <i>Window handle Q7 DK-tilt & turn handle with pins D.9,5 / metric-thread screw</i>	R099700C48007	R099700C48013	R099700C48027	2
	18,30	18,30	18,60	
997/00A4 DK x 42 C/CHIAVE VM C/BUSS. 2 Martellina con chiave DK Q7 x 42 con bussole D.9,5 mm viti metriche <i>Window handle Q7 DK-tilt & turn handle with key with pins D.9,5 / metric-thread screw</i>	R099700A4840790	R099700A4841390	R099700A4842790	1
	71,10	71,10	73,95	



OCS-M18

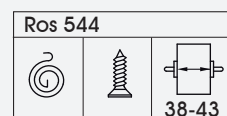
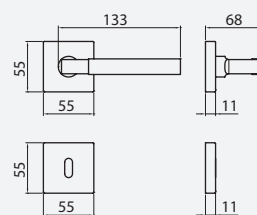
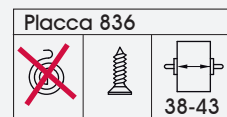
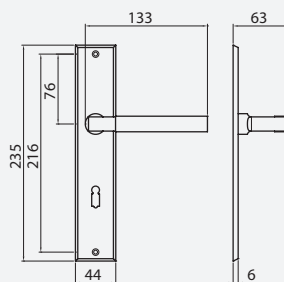

OCL-M4



ONS-M9



1

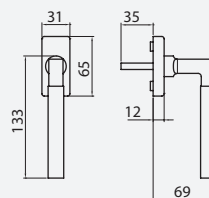

2

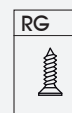
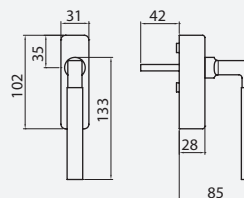

Per maggiori informazioni - For more information:

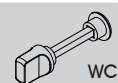

R1230

	OCS M18	OCL M4	ONS M9	Conf. pz.
1230/836 Q8 BB72 VL Guarnitura Q8 placca BB 72 con viti legno <i>Lever handle Q8 on key plate 72 with wood screw</i>	R123008367303 95,30	R123008367307 95,30	R123008367327 98,80	1
1230/836 Q8 PZ72 VL Guarnitura Q8 placca Yale 72 con viti legno <i>Lever handle Q8 on cyl. plate 72 with wood screw</i>	R123008367703 95,30	R123008367707 95,30	R123008367727 98,80	1
1230/836 Q8 WC78 Q8 VL Guarnitura Q8 placca WC 78 Q8 viti legno <i>Lever handle Q8 on WC Q8 function plate 78 with wood screw</i>	R123008369803 106,00	R123008369807 106,00	R123008369827 110,10	1
1230/544 Q8 RQ VL Guarnitura Q8 ros. senza bocc. con viti legno <i>Lever handle Q8 on rose with wood screw</i>	R12300544050360 81,55	R12300544050760 81,55	R12300544052760 82,85	1
1230/544 Q8 RBQ BB VL Guarnitura Q8 ros./bocc. BB con viti legno <i>Lever handle Q8 on rose-key escutcheon with wood screw</i>	R12300544100360 92,45	R12300544100760 92,45	R12300544102760 92,85	1
1230/544 Q8 RBQ PZ VL Guarnitura Q8 ros./bocc. Yale con viti legno <i>Lever handle Q8 on rose-cyl escutcheon with wood screw</i>	R12300544500360 92,45	R12300544500760 92,45	R12300544502760 92,85	1
1230/544 Q8 RBQ WC Q8 VL Guarnitura Q8 ros./bocc. WC Q8 con viti legno <i>Lever handle Q8 on rose-WC Q8 function with wood screw</i>	R12300544880360 100,35	R12300544880760 100,35	R12300544882760 100,65	1
1230/544 Q8 RQ C/BUSS. VPM Guarnitura Q8 ros. senza bocc. con buss. viti passanti metriche <i>Lever handle Q8 on rose with pins / metric-thread screw</i>	R12300544050340 81,80	R12300544050740 81,80	R12300544052740 83,10	1
1230/544 Q8 RBQ BB C/BUSS. VPM Guarnitura Q8 ros./bocc. BB con buss. viti passanti metriche <i>Lever handle Q8 on rose-key escutcheon with pins / metric-thread screw</i>	R12300544100340 92,70	R12300544100740 92,70	R12300544102740 93,10	1
1230/544 Q8 RBQ PZ C/BUSS. VPM Guarnitura Q8 ros./bocc. Yale con buss. viti passanti metriche <i>Lever handle Q8 on rose-cyl escutcheon with pins / metric-thread screw</i>	R12300544500340 92,70	R12300544500740 92,70	R12300544502740 93,10	1
1230/544 Q8 RBQ WC Q8 C/BUSS. VPM Guarnitura Q8 ros./bocc. WC Q8 con buss. viti passanti metriche <i>Lever handle Q8 on rose-WC Q8 function with pins / metric-thread screw</i>	R12300544880340 100,60	R12300544880740 100,60	R12300544882740 100,90	1
1230/00C4 DK x 35 VM C/BUSS. 1 Martellina DK Q7 x 35 con bussole D.9,5 mm viti metriche <i>Window handle Q7 DK-tilt & turn handle with pins D.9,5 / metric-thread screw</i>	R123000C4800390 38,90	R123000C4800790 38,90	R123000C4802790 40,10	1
1230/00A4 DK x 42 C/CHIAVE VM C/BUSS. 2 Martellina con chiave DK Q7 x 42 con bussole D.9,5 mm viti metriche <i>Window handle Q7 DK-tilt & turn handle with key with pins D.9,5 / metric-thread screw</i>	R123000A4840390 91,60	R123000A4840790 91,60	R123000A4842790 92,25	1

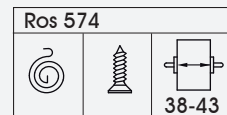
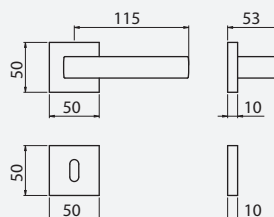

OCS-M18

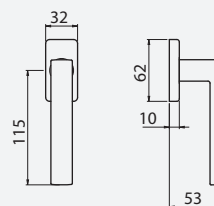

OLV-M1



OCL-M4



Per maggiori informazioni - For more information:

Rosette da pag. 246 a pag. 257 Roses from pag. 246 to pag. 257
 Placche da pag. 265 a pag. 267 Plates from pag. 265 to pag. 267
 DK da pag. 262 a pag. 264 Window handles from pag. 262 to pag. 264

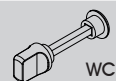

	OLV M1	OCS M18	OCL M4	Conf. pz.
Q8 RQ Guarnitura Q8 ros. senza bocc. <i>Lever handle Q8 on rose</i>	55460280001	55460280003	55460280007	1
	50,40	52,00	52,00	
Q8 RBQ Guarnitura Q8 ros./bocc. patent <i>Lever handle Q8 on rose-key escutcheon</i>	55460281001	55460281003	55460281007	1
	56,60	58,80	58,80	
Q8 RBQY Guarnitura Q8 ros./bocc. yale <i>Lever handle Q8 on rose-cyl escutcheon</i>	55460285001	55460285003	55460285007	1
	56,60	58,80	58,80	
Q8 RBQWC Guarnitura Q8 ros./bocc.Wc <i>Lever handle Q8 on rose-WC function</i>	55460288001	55460288003	55460288007	1
	62,00	65,00	65,00	

	OLV M1	OCS M18	OCL M4	Conf. pz.
DK x 40 Martellina DK Q7 x 40 <i>Window handle Q7 DK-tilt & turn handle</i>	55460557001	55460557003	55460557007	2
	24,20	25,80	25,80	
DK x 40 C/BUSS. Martellina DK Q7 x 40 con bussole D. 9,5 <i>Window handle Q7 DK-tilt & turn handle with pins d.9,5</i>	55460558001	55460558003	55460558007	2
	24,20	25,80	25,80	

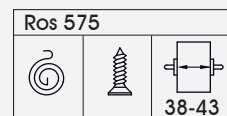
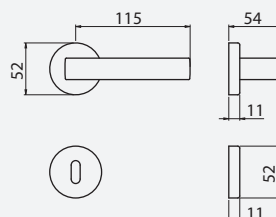

OCS-M18

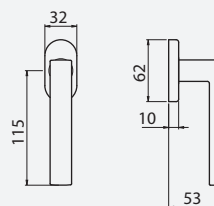

OLV-M1



OCL-M4



Per maggiori informazioni - For more information:

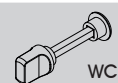

	OLV M1	OCS M18	OCL M4	Conf. pz.
Q8 RT Guarnitura Q8 ros. senza bocc. <i>Lever handle Q8 on rose</i>	55460280901	55460280903	55460280907	1
	47,00	48,90	48,90	
Q8 RBT Guarnitura Q8 ros./bocc. patent <i>Lever handle Q8 on rose-key escutcheon</i>	55460281901	55460281903	55460281907	1
	50,40	53,00	53,00	
Q8 RBTY Guarnitura Q8 ros./bocc. yale <i>Lever handle Q8 on rose-cyl escutcheon</i>	55460285901	55460285903	55460285907	1
	50,40	53,00	53,00	
Q8 RBTWC Guarnitura Q8 ros./bocc.Wc <i>Lever handle Q8 on rose-WC function</i>	55460288901	55460288903	55460288907	1
	55,90	58,80	58,80	

	OLV M1	OCS M18	OCL M4	Conf. pz.
DK x 40 Martellina DK Q7 x 40 <i>Window handle Q7 DK-tilt & turn handle</i>	55460567001	55460567003	55460567007	2
	22,80	24,50	24,50	
DK x 40 C/BUSS. Martellina DK Q7 x 40 con bussole D. 9,5 <i>Window handle Q7 DK-tilt & turn handle with pins d.9,5</i>	55460568001	55460568003	55460568007	2
	22,80	24,50	24,50	

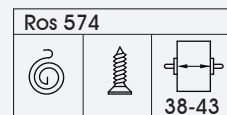
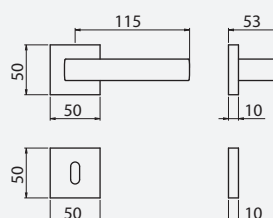

ZCS

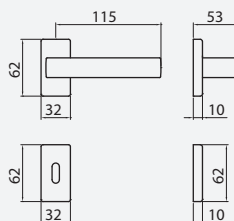

ZCL



ZNS

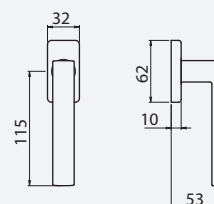

Per maggiori informazioni - For more information:

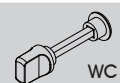

	ZCL	ZCS	ZNS	Conf. pz.
Q8 RQ Guarnitura Q8 ros. senza bocc. <i>Lever handle Q8 on rose</i>	66460280007 29,60	66460280013 29,60	66460280027 32,50	1
Q8 RBQ Guarnitura Q8 ros./bocc. patent <i>Lever handle Q8 on rose-key escutcheon</i>	66460281007 36,60	66460281013 36,60	66460281027 39,45	1
Q8 RBQY Guarnitura Q8 ros./bocc. yale <i>Lever handle Q8 on rose-cyl escutcheon</i>	66460285007 36,60	66460285013 36,60	66460285027 39,45	1
Q8 RBQWC Guarnitura Q8 ros./bocc.Wc <i>Lever handle Q8 on rose-WC function</i>	66460288007 43,70	66460288013 43,70	66460288027 47,00	1

	ZCL	ZCS	ZNS	Conf. pz.
Q8 RRC Guarnitura Q8 ros. senza bocc. <i>Lever handle Q8 on rose</i>	66460210407 34,30	66460210413 34,30	66460210427 37,20	1
Q8 RBRC Guarnitura Q8 ros./bocc. Patent <i>Lever handle Q8 on rose-key escutcheon</i>	66460211407 41,40	66460211413 41,40	66460211427 44,25	1
Q8 RBRYC Guarnitura Q8 ros./bocc. Yale <i>Lever handle Q8 on rose-cyl escutcheon</i>	66460215407 41,40	66460215413 41,40	66460215427 44,25	1

	ZCL	ZCS	ZNS	Conf. pz.
DK x 40 Martellina DK Q7 x 40 <i>Window handle Q7 DK-tilt & turn handle</i>	66460557007 14,40	66460557013 14,40	66460557027 15,80	2
DK x 40 C/BUSS. Martellina DK Q7 x 40 con bussole D. 9,5 <i>Window handle Q7 DK-tilt & turn handle with pins d.9,5</i>	66460558007 14,40	66460558013 14,40	66460558027 15,80	2

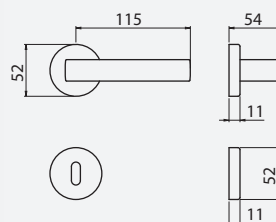

Ros 575		
38-43		

ZCS

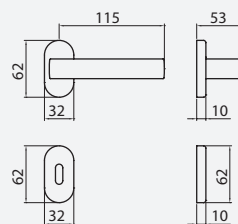

Ros 0006		
38-43		



ZCL



ZNS

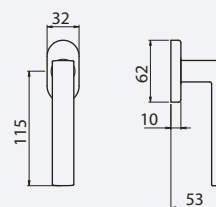

Per maggiori informazioni - For more information:

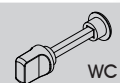

	ZCL	ZCS	ZNS	Conf. pz.
Q8 RT Guarnitura Q8 ros. senza bocc. <i>Lever handle Q8 on rose</i>	66460280907 26,70	66460280913 26,70	66460280927 30,15	1
Q8 RBT Guarnitura Q8 ros./bocc. patent <i>Lever handle Q8 on rose-key escutcheon</i>	66460281907 31,50	66460281913 31,50	66460281927 34,90	1
Q8 RBTY Guarnitura Q8 ros./bocc. yale <i>Lever handle Q8 on rose-cyl escutcheon</i>	66460285907 31,50	66460285913 31,50	66460285927 34,90	1
Q8 RBTWC Guarnitura Q8 ros./bocc.Wc <i>Lever handle Q8 on rose-WC function</i>	66460288907 38,40	66460288913 38,40	66460288927 42,40	1

	ZCL	ZCS	ZNS	Conf. pz.
Q8 ROC Guarnitura Q8 ros. senza bocc. <i>Lever handle Q8 on rose</i>	66460220607 32,50	66460220613 32,50	66460220627 35,95	1
Q8 RBOC Guarnitura Q8 ros./bocc. Patent <i>Lever handle Q8 on rose-key escutcheon</i>	66460221607 37,80	66460221613 37,80	66460221627 41,20	1
Q8 RBOYC Guarnitura Q8 ros./bocc. Yale <i>Lever handle Q8 on rose-cyl escutcheon</i>	66460225607 37,80	66460225613 37,80	66460225627 41,20	1

	ZCL	ZCS	ZNS	Conf. pz.
DK x 40 Martellina DK Q7 x 40 <i>Window handle Q7 DK-tilt & turn handle</i>	66460567007 13,20	66460567013 13,20	66460567027 13,60	2
DK x 40 C/BUSS. Martellina DK Q7 x 40 con bussole D. 9,5 <i>Window handle Q7 DK-tilt & turn handle with pins d.9,5</i>	66460568007 13,20	66460568013 13,20	66460568027 13,60	2



ZCS

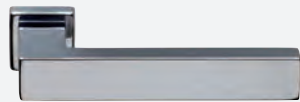
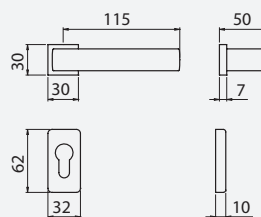
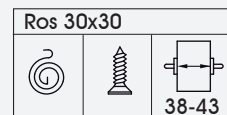
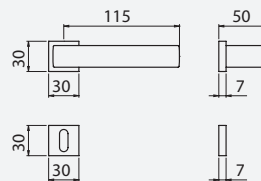

ZCL

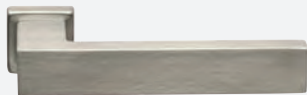

ZNS

Per maggiori informazioni - For more information:

YORK Z

	ZCL	ZCS	ZNS	Conf. pz.
Q8 RBQ 30x30 Guarnitura Q8 ros./bocc. quadra patent <i>Lever handle Q8 on rose-key escutcheon</i>	66460261607	66460261613	66460261627	1
	36,60	36,60	39,45	

	ZCL	ZCS	ZNS	Conf. pz.
Q8 RQ 30x30 BRettY 30x60 Guarnitura Q8 ros.quadra bocc.rettangolare Yale <i>Lever handle Q8 on rose-cyl escutcheon</i>	66460265607	66460265613	66460265627	1
	36,60	36,60	39,45	



ZCL

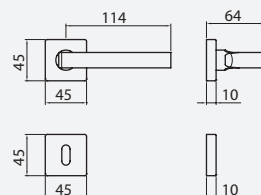

Ros 45x45		
38-43		
A richiesta / On request		
38	30	
50	50	

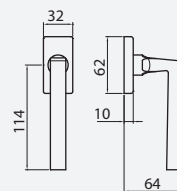

ZCS



Per maggiori informazioni - For more information:

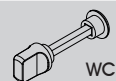

	ZCL	ZCS	Conf. pz.
Q8 RQ45 Guarnitura Q8 ros. senza bocc. <i>Lever handle Q8 on rose</i>	6GM07240507 20,30	6GM07240513 20,30	1
Q8 RBQ45 Guarnitura Q8 ros./bocc. patent <i>Lever handle Q8 on rose-key escutcheon</i>	6GM07241507 25,10	6GM07241513 25,10	1
Q8 RBQY45 Guarnitura Q8 ros./bocc. Yale <i>Lever handle Q8 on rose-cyl escutcheon</i>	6GM07245507 25,10	6GM07245513 25,10	1
Q8 RBQWC45 Guarnitura Q8 ros./bocc.Wc <i>Lever handle Q8 on rose-WC function</i>	6GM07248007 31,80	6GM07248013 31,80	1

	ZCL	ZCS	Conf. pz.
DK x 40 Martellina DK Q7 x 40 <i>Window handle Q7 DK-tilt & turn handle</i>	6GM07555007 12,10	6GM07555013 12,10	2
DK x 40 C/BUSS Martellina DK Q7 x 40 con bussole D. 9,5 <i>Window handle Q7 DK-tilt & turn handle with pins D. 9,5</i>	6GM07556007 12,10	6GM07556013 12,10	2



ZCS

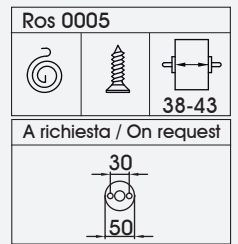
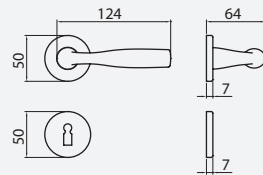
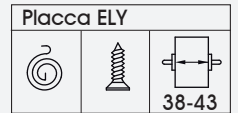
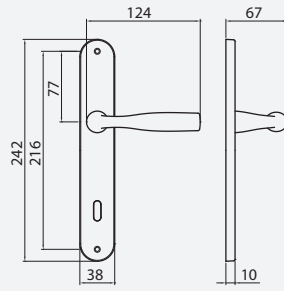

ZCL



GCTOL



ZNS

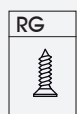
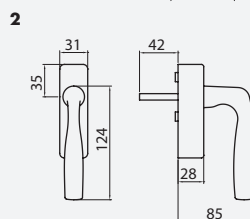
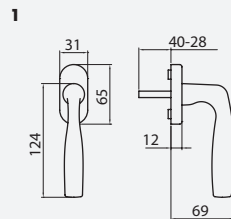

Per maggiori informazioni - For more information:

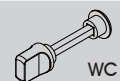

WC

	ZCL	GCTOL	ZCS	ZNS	Conf. pz.
Q8 P70 VL Guarnitura Q8 placca P70 con viti legno <i>Lever handle Q8 on key plate 72 with wood screw</i>	66480087007	66480087012	66480087013	66480087027	1
	32,85	30,20	32,85	34,50	
Q8 BB72 VL Guarnitura Q8 placca BB 72 con viti legno <i>Lever handle Q8 on key plate 72 with wood screw</i>	66480087307	66480087312	66480087313	66480087327	1
	32,85	30,20	32,85	34,50	
Q8 PZ72 VL Guarnitura Q8 placca Yale 72 con viti legno <i>Lever handle Q8 on cyl. plate 72 with wood screw</i>	66480087707	66480087712	66480087713	66480087727	1
	32,85	30,20	32,85	34,50	
Q8 PZ85 VL Guarnitura Q8 placca Yale 85 con viti legno <i>Lever handle Q8 on cyl. plate 85 with wood screw</i>	66480088507	66480088512	66480088513	66480088527	1
	32,85	30,20	32,85	34,50	
Q8 P90 VL Guarnitura Q8 placca P90 con viti legno <i>Lever handle Q8 on key plate 90 with wood screw</i>	66480089007	66480089012	66480089013	66480089027	1
	32,85	30,20	32,85	34,50	
Q8 WC78 Q8 VL Guarnitura Q8 placca WC 78 Q8 viti legno <i>Lever handle Q8 on WC Q8 function plate 78 with wood screw</i>	66480089807	66480089812	66480089813	66480089827	1
	40,80	36,40	40,80	42,40	
Q8 R50 VL Guarnitura Q8 ros. senza bocc. con viti legno <i>Lever handle Q8 on rose with wood screw</i>	66480230507	66480230512	66480230513	66480230527	1
	21,25	20,95	21,25	22,55	
Q8 RB50 VL Guarnitura Q8 ros./bocc. Patent con viti legno <i>Lever handle Q8 on rose-key escutcheon with wood screw</i>	66480231507	66480231512	66480231513	66480231527	1
	24,90	24,05	24,90	26,75	
Q8 RB50 BB VL Guarnitura Q8 ros./bocc. BB con viti legno <i>Lever handle Q8 on rose-key escutcheon with wood screw</i>	66480231207	66480231212	66480231213	66480231227	1
	24,90	24,05	24,90	26,75	
Q8 RB50 PZ VL Guarnitura Q8 ros./bocc. Yale con viti legno <i>Lever handle Q8 on rose-cyl escutcheon with wood screw</i>	66480235507	66480235512	66480235513	66480235527	1
	24,90	24,05	24,90	26,75	
Q8 RB50 WC Q6 VL Guarnitura Q8 ros./bocc. WC Q6 con viti legno <i>Lever handle Q8 on rose-WC Q6 function with wood screw</i>	66480238607	66480238612	66480238613	66480238627	1
	32,85	30,75	32,85	34,65	
Q8 RB50 WC Q8 VL Guarnitura Q8 ros./bocc. WC Q8 con viti legno <i>Lever handle Q8 on rose-WC Q8 function with wood screw</i>	66480238907	66480238912	66480238913	66480238927	1
	32,85	30,75	32,85	34,65	
Q8 R50 C/BUSS. VPA Guarnitura Q8 ros. senza bocc. con buss. viti passanti autofilettanti <i>Lever handle Q8 on rose with pins / thread forming screw</i>	6648023050700	6648023051200	6648023051300	6648023052700	1
	21,50	21,20	21,50	22,80	
Q8 RB50 C/BUSS. VPA Guarnitura Q8 ros./bocc. Patent con buss. viti passanti autofilettanti <i>Lever handle Q8 on rose-key escutcheon with pins / thread forming screw</i>	6648023150700	6648023151200	6648023151300	6648023152700	1
	25,15	24,30	25,15	27,00	
Q8 RB50 BB C/BUSS. VPA Guarnitura Q8 ros./bocc. BB con buss. viti passanti autofilettanti <i>Lever handle Q8 on rose-key escutcheon with pins / thread forming screw</i>	6648023120700	6648023121200	6648023121300	6648023122700	1
	25,15	24,30	25,15	27,00	
Q8 RB50 PZ C/BUSS. VPA Guarnitura Q8 ros./bocc. Yale con buss. viti passanti autofilettanti <i>Lever handle Q8 on rose-cyl escutcheon with pins / thread forming screw</i>	6648023550700	6648023551200	6648023551300	6648023552700	1
	25,15	24,30	25,15	27,00	
Q8 RB50 WC Q6 C/BUSS. VPA Guarnitura Q8 ros./bocc. WC Q6 con buss. viti passanti autofilettanti <i>Lever handle Q8 on rose-WC Q6 function with pins / thread forming screw</i>	6648023860700	6648023861200	6648023861300	6648023862700	1
	33,10	31,00	33,10	34,90	
Q8 RB50 WC Q8 C/BUSS. VPA Guarnitura Q8 ros./bocc. WC Q8 con buss. viti passanti autofilettanti <i>Lever handle Q8 on rose-WC Q8 function with pins / thread forming screw</i>	6648023890700	6648023891200	6648023891300	6648023892700	1
	33,10	31,00	33,10	34,90	
DK x 40-28 C/BUSS 1 Martellina DK Q7 x 40-28 con bussole D.9,5 <i>Window handle Q7 DK-tilt & turn handle with pins D.9,5</i>	66480552807	66480552812	66480552813	66480552827	2
	14,00	13,80	14,00	14,65	
DK x 42 C/CHIAVE C/BUSS. 2 Martellina con chiave DK Q7 x 42 con bussole D.9,5 <i>Window handle Q7 DK-tilt & turn handle with key with pins D.9,5</i>	66480563507	66480563512	66480563513	66480563527	1
	71,70	71,50	71,70	72,35	



OFA-M69

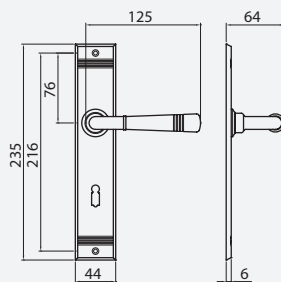

Placca 818		
		38-43

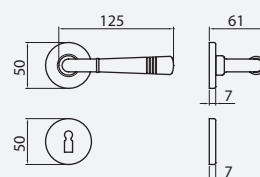

Ros 0005		
		38-43
A richiesta / On request		



OLD-MV3



OANT-M75

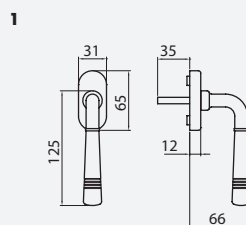

DK-1F

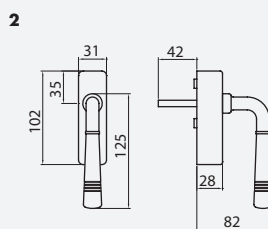

RG

Per maggiori informazioni - For more information:



	OLD MV3	OFA M69	OANT M75	Conf. pz.
716/818 Q8 BB72 VL Guarnitura Q8 placca BB 72 con viti legno <i>Lever handle Q8 on key plate 72 with wood screw</i>	R071608187328	R071608187329	R071608187342	1
	37,50	49,50	52,30	
716/818 Q8 PZ72 VL Guarnitura Q8 placca Yale 72 con viti legno <i>Lever handle Q8 on cyl. plate 72 with wood screw</i>	R071608187728	R071608187729	R071608187742	1
	37,50	49,50	52,30	
716/818 Q8 WC78 Q8 VL Guarnitura Q8 placca WC 78 Q8 viti legno <i>Lever handle Q8 on WC Q8 function plate 78 with wood screw</i>	R071608189828	R071608189829	R071608189842	1
	44,10	59,30	61,60	
716/0005 Q8 R VL Guarnitura Q8 ros. senza bocc. con viti legno <i>Lever handle Q8 on rose with wood screw</i>	R07160005052860	R07160005052960	R07160005054260	1
	27,85	34,25	31,25	
716/0005 Q8 RB BB VL Guarnitura Q8 ros./bocc. BB con viti legno <i>Lever handle Q8 on rose-key escutcheon with wood screw</i>	R07160005122860	R07160005122960	R07160005124260	1
	30,05	39,65	36,05	
716/0005 Q8 RB PZ VL Guarnitura Q8 ros./bocc. Yale con viti legno <i>Lever handle Q8 on rose-cyl escutcheon with wood screw</i>	R07160005502860	R07160005502960	R07160005504260	1
	30,05	39,65	36,05	
716/0005 Q8 RB WC Q8 VL Guarnitura Q8 ros./bocc. WC Q8 con viti legno <i>Lever handle Q8 on rose-WC Q8 function with wood screw</i>	R07160005882860	R07160005882960	R07160005884260	1
	38,55	49,95	45,65	
716/0005 Q8 R C/BUSS. VPA Guarnitura Q8 ros. senza bocc. con buss. viti passanti autofilettanti <i>Lever handle Q8 on rose with pins / thread forming screw</i>	R071600050528	R071600050529	R071600050542	1
	28,10	34,50	31,50	
716/0005 Q8 RB BB C/BUSS. VPA Guarnitura Q8 ros./bocc. BB con buss. viti passanti autofilettanti <i>Lever handle Q8 on rose-key escutcheon with pins / thread forming screw</i>	R071600051228	R071600051229	R071600051242	1
	30,30	39,90	36,30	
716/0005 Q8 RB PZ C/BUSS. VPA Guarnitura Q8 ros./bocc. Yale con buss. viti passanti autofilettanti <i>Lever handle Q8 on rose-cyl escutcheon with pins / thread forming screw</i>	R071600055028	R071600055029	R071600055042	1
	30,30	39,90	36,30	
716/0005 Q8 RB WC Q8 C/BUSS. VPA Guarnitura Q8 ros./bocc. WC Q8 con buss. viti passanti autofilettanti <i>Lever handle Q8 on rose-WC Q8 function with pins / thread forming screw</i>	R071600058828	R071600058829	R071600058842	1
	38,80	50,20	45,90	
716/0004 DK x 35 VM C/BUSS. 1 Martellina DK Q7 x 35 con bussole D.9,5 mm viti metriche <i>Window handle Q7 DK-tilt & turn handle with pins D.9,5 / metric-thread screw</i>	R07160004802890	R07160004802990	R07160004804290	1
	17,20	20,90	19,40	
716/00A4 DK x 42 C/CHIAVE VM C/BUSS. 2 Martellina con chiave DK Q7 x 42 con bussole D.9,5 mm viti metriche <i>Window handle Q7 DK-tilt & turn handle with key with pins D.9,5 / metric-thread screw</i>	R071600A4842890	R071600A4842990	R071600A4844290	1
	57,20	75,20	76,20	



OCL-M4

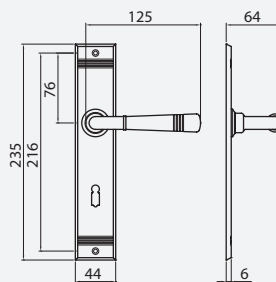

Placca 818		
		38-43

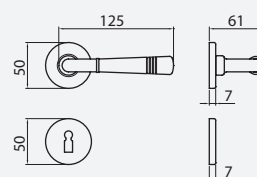

Ros 0005		
		38-43
A richiesta / On request		



OLV-M1



ONS-M9

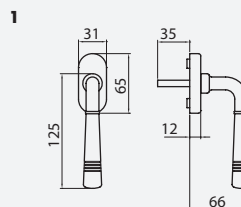

DK-1F

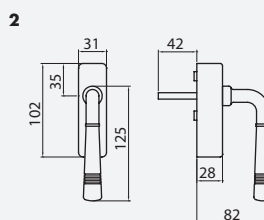

RG

Per maggiori informazioni - For more information:

Rosette da pag. 246 a pag. 257 Roses from pag. 246 to pag. 257
 Placche da pag. 265 a pag. 267 Plates from pag. 265 to pag. 267
 DK da pag. 262 a pag. 264 Window handles from pag. 262 to pag. 264



	OLV M1	OCL M4	ONS M9	Conf. pz.
716/818 Q8 BB72 VL Guarnitura Q8 placca BB 72 con viti legno <i>Lever handle Q8 on key plate 72 with wood screw</i>	R071608187301	R071608187307	R071608187327	1
	41,10	42,30	44,80	
716/818 Q8 PZ72 VL Guarnitura Q8 placca Yale 72 con viti legno <i>Lever handle Q8 on cyl. plate 72 with wood screw</i>	R071608187701	R071608187707	R071608187727	1
	41,10	42,30	44,80	
716/818 Q8 WC78 Q8 VL Guarnitura Q8 placca WC 78 Q8 viti legno <i>Lever handle Q8 on WC Q8 function plate 78 with wood screw</i>	R071608189801	R071608189807	R071608189827	1
	48,80	50,00	53,00	
716/0005 Q8 R VL Guarnitura Q8 ros. senza bocc. con viti legno <i>Lever handle Q8 on rose with wood screw</i>	R07160005050160	R07160005050760	R07160005052760	1
	27,95	30,55	34,25	
716/0005 Q8 RB BB VL Guarnitura Q8 ros./bocc. BB con viti legno <i>Lever handle Q8 on rose-key escutcheon with wood screw</i>	R07160005120160	R07160005120760	R07160005122760	1
	30,65	33,95	38,05	
716/0005 Q8 RB PZ VL Guarnitura Q8 ros./bocc. Yale con viti legno <i>Lever handle Q8 on rose-cyl escutcheon with wood screw</i>	R07160005500160	R07160005500760	R07160005502760	1
	30,65	33,95	38,05	
716/0005 Q8 RB WC Q8 VL Guarnitura Q8 ros./bocc. WC Q8 con viti legno <i>Lever handle Q8 on rose-WC Q8 function with wood screw</i>	R07160005880160	R07160005880760	R07160005882760	1
	38,05	44,15	49,55	
716/0005 Q8 R C/BUSS. VPA Guarnitura Q8 ros. senza bocc. con buss. viti passanti autofilettanti <i>Lever handle Q8 on rose with pins / thread forming screw</i>	R071600050501	R071600050507	R071600050527	1
	28,20	30,80	34,50	
716/0005 Q8 RB BB C/BUSS. VPA Guarnitura Q8 ros./bocc. BB con buss. viti passanti autofilettanti <i>Lever handle Q8 on rose-key escutcheon with pins / thread forming screw</i>	R071600051201	R071600051207	R071600051227	1
	30,90	34,20	38,30	
716/0005 Q8 RB PZ C/BUSS. VPA Guarnitura Q8 ros./bocc. Yale con buss. viti passanti autofilettanti <i>Lever handle Q8 on rose-cyl escutcheon with pins / thread forming screw</i>	R071600055001	R071600055007	R071600055027	1
	30,90	34,20	38,30	
716/0005 Q8 RB WC Q8 C/BUSS. VPA Guarnitura Q8 ros./bocc. WC Q8 con buss. viti passanti autofilettanti <i>Lever handle Q8 on rose-WC Q8 function with pins / thread forming screw</i>	R071600058801	R071600058807	R071600058827	1
	38,30	44,40	49,80	
716/0004 DK x 35 VM C/BUSS. 1 Martellina DK Q7 x 35 con bussole D.9,5 mm viti metriche <i>Window handle Q7 DK-tilt & turn handle with pins D.9,5 / metric-thread screw</i>	R07160004800190	R07160004800790	R07160004802790	1
	19,70	20,20	21,10	
716/00A4 DK x 42 C/CHIAVE VM C/BUSS. 2 Martellina con chiave DK Q7 x 42 con bussole D.9,5 mm viti metriche <i>Window handle Q7 DK-tilt & turn handle with key with pins D.9,5 / metric-thread screw</i>	R071600A4840190	R071600A4840790	R071600A4842790	1
	72,40	73,00	75,90	



ONL/EB-E7

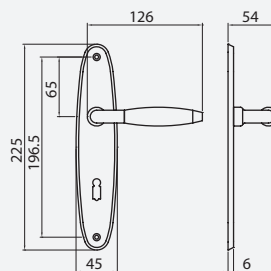

Placca 870		
		38-43

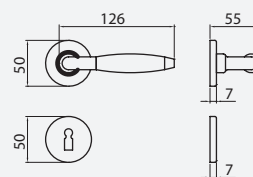

Ros 0005		
		38-43

A richiesta / On request	



OCL/EB-E4

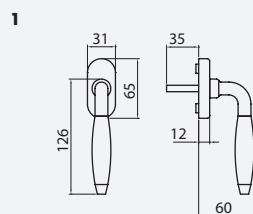

DK-1F

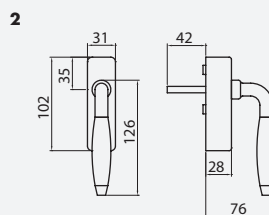

RG

Per maggiori informazioni - For more information:



	OCL / EB E4	ONL / EB E7	Conf. pz.
744/870 Q8 BB72 VL Guarnitura Q8 placca BB 72 con viti legno <i>Lever handle Q8 on key plate 72 with wood screw</i>	R0744087073E7 76,00	R0744087073EN 76,00	1
744/870 Q8 PZ72 VL Guarnitura Q8 placca Yale 72 con viti legno <i>Lever handle Q8 on cyl. plate 72 with wood screw</i>	R0744087077E7 76,00	R0744087077EN 76,00	1
744/870 Q8 WC78 Q8 VL Guarnitura Q8 placca WC 78 Q8 viti legno <i>Lever handle Q8 on WC Q8 function plate 78 with wood screw</i>	R0744087098E7 86,80	R0744087098EN 86,80	1
744/0005 Q8 R VL Guarnitura Q8 ros. senza bocc. con viti legno <i>Lever handle Q8 on rose with wood screw</i>	R0744000505E760 55,75	R0744000505EN60 55,75	1
744/0005 Q8 RB BB VL Guarnitura Q8 ros./bocc. BB con viti legno <i>Lever handle Q8 on rose-key escutcheon with wood screw</i>	R0744000512E760 59,85	R0744000512EN60 59,85	1
744/0005 Q8 RB PZ VL Guarnitura Q8 ros./bocc. Yale con viti legno <i>Lever handle Q8 on rose-cyl escutcheon with wood screw</i>	R0744000550E760 59,85	R0744000550EN60 59,85	1
744/0005 Q8 RB WC Q8 VL Guarnitura Q8 ros./bocc. WC Q8 con viti legno <i>Lever handle Q8 on rose-WC Q8 function with wood screw</i>	R0744000588E760 70,65	R0744000588EN60 70,65	1
744/0005 Q8 R C/BUSS. VPA Guarnitura Q8 ros. senza bocc. con buss. viti passanti autofilettanti <i>Lever handle Q8 on rose with pins / thread forming screw</i>	R0744000505E7 56,00	R0744000505EN 56,00	1
744/0005 Q8 RB BB C/BUSS. VPA Guarnitura Q8 ros./bocc. BB con buss. viti passanti autofilettanti <i>Lever handle Q8 on rose-key escutcheon with pins / thread forming screw</i>	R0744000512E7 60,10	R0744000512EN 60,10	1
744/0005 Q8 RB PZ C/BUSS. VPA Guarnitura Q8 ros./bocc. Yale con buss. viti passanti autofilettanti <i>Lever handle Q8 on rose-cyl escutcheon with pins / thread forming screw</i>	R0744000550E7 60,10	R0744000550EN 60,10	1
744/0005 Q8 RB WC Q8 C/BUSS. VPA Guarnitura Q8 ros./bocc. WC Q8 con buss. viti passanti autofilettanti <i>Lever handle Q8 on rose-WC Q8 function with pins / thread forming screw</i>	R0744000588E7 70,90	R0744000588EN 70,90	1
744/0004 DK x 35 VM C/BUSS. 1 Martellina DK Q7 x 35 con bussole D.9,5 mm viti metriche <i>Window handle Q7 DK-tilt & turn handle with pins D.9,5 / metric-thread screw</i>	R0744000480E790 30,50	R0744000480EN90 30,50	1
744/00A4 DK x 42 C/CHIAVE VM C/BUSS. 2 Martellina con chiave DK Q7 x 42 con bussole D.9,5 mm viti metriche <i>Window handle Q7 DK-tilt & turn handle with key with pins D.9,5 / metric-thread screw</i>	R074400A484E790 82,80	R074400A484EN90 82,80	1



OLV-M1

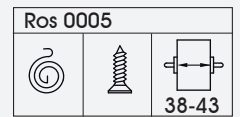
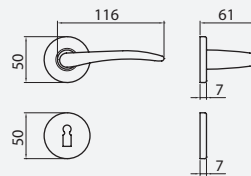
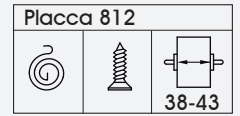
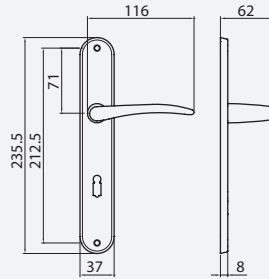

OCS-M18



OCL-M4



ONS-M9

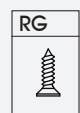
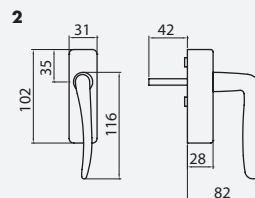
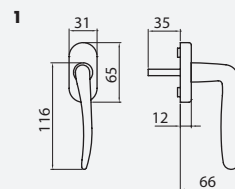

Per maggiori informazioni - For more information:

Rosette da pag. 246 a pag. 257
 Placche da pag. 265 a pag. 267
 DK da pag. 262 a pag. 264

Roses from pag. 246 to pag. 257
 Plates from pag. 265 to pag. 267
 Window handles from pag. 262 to pag. 264



	OLV M1	OCS M18	OCL M4	ONS M9	Conf. pz.
771/812 Q8 BB72 VL Guarnitura Q8 placca BB 72 con viti legno <i>Lever handle Q8 on key plate 72 with wood screw</i>	R077108127301	R077108127303	R077108127307	R077108127327	1
	30,60	42,40	42,40	44,40	
771/812 Q8 PZ72 VL Guarnitura Q8 placca Yale 72 con viti legno <i>Lever handle Q8 on cyl. plate 72 with wood screw</i>	R077108127701	R077108127703	R077108127707	R077108127727	1
	30,60	42,40	42,40	44,40	
771/812 Q8 WC78 Q8 VL Guarnitura Q8 placca WC 78 Q8 viti legno <i>Lever handle Q8 on WC Q8 function plate 78 with wood screw</i>	R077108129801	R077108129803	R077108129807	R077108129827	1
	38,90	53,30	53,30	55,90	
771/0005 Q8 R VL Guarnitura Q8 ros. senza bocc. con viti legno <i>Lever handle Q8 on rose with wood screw</i>	R07710005050160	R07710005050360	R07710005050760	R07710005052760	1
	22,45	25,85	25,85	33,85	
771/0005 Q8 RB BB VL Guarnitura Q8 ros./bocc. BB con viti legno <i>Lever handle Q8 on rose-key escutcheon with wood screw</i>	R07710005120160	R07710005120360	R07710005120760	R07710005122760	1
	24,75	29,15	29,15	38,15	
771/0005 Q8 RB PZ VL Guarnitura Q8 ros./bocc. Yale con viti legno <i>Lever handle Q8 on rose-cyl escutcheon with wood screw</i>	R07710005500160	R07710005500360	R07710005500760	R07710005502760	1
	24,75	29,15	29,15	38,15	
771/0005 Q8 RB WC Q8 VL Guarnitura Q8 ros./bocc. WC Q8 con viti legno <i>Lever handle Q8 on rose-WC Q8 function with wood screw</i>	R07710005880160	R07710005880360	R07710005880760	R07710005882760	1
	32,65	39,65	39,65	51,25	
771/0005 Q8 R C/BUSS. VPA Guarnitura Q8 ros. senza bocc. con buss. viti passanti autofilettanti <i>Lever handle Q8 on rose with pins / thread forming screw</i>	R077100050501	R077100050503	R077100050507	R077100050527	1
	22,70	26,10	26,10	34,10	
771/0005 Q8 RB BB C/BUSS. VPA Guarnitura Q8 ros./bocc. BB con buss. viti passanti autofilettanti <i>Lever handle Q8 on rose-key escutcheon with pins / thread forming screw</i>	R077100051201	R077100051203	R077100051207	R077100051227	1
	25,00	29,40	29,40	38,40	
771/0005 Q8 RB PZ C/BUSS. VPA Guarnitura Q8 ros./bocc. Yale con buss. viti passanti autofilettanti <i>Lever handle Q8 on rose-cyl escutcheon with pins / thread forming screw</i>	R077100055001	R077100055003	R077100055007	R077100055027	1
	25,00	29,40	29,40	38,40	
771/0005 Q8 RB WC Q8 C/BUSS. VPA Guarnitura Q8 ros./bocc. WC Q8 con buss. viti passanti autofilettanti <i>Lever handle Q8 on rose-WC Q8 function with pins / thread forming screw</i>	R077100058801	R077100058803	R077100058807	R077100058827	1
	32,90	39,90	39,90	51,50	
771/0004 DK x 35 VM C/BUSS. 1 Martellina DK Q7 x 35 con bussole D.9,5 mm viti metriche <i>Window handle Q7 DK-tilt & turn handle with pins D.9,5 / metric-thread screw</i>	R07710004800190	R07710004800390	R07710004800790	R07710004802790	1
	17,30	18,10	18,10	18,80	
771/00A4 DK x 42 C/CHIAVE VM C/BUSS. 2 Martellina con chiave DK Q7 x 42 con bussole D.9,5 mm viti metriche <i>Window handle Q7 DK-tilt & turn handle with key with pins D.9,5 / metric-thread screw</i>	R077100A4840190	R077100A4840390	R077100A4840790	R077100A4842790	1
	70,10	70,70	70,70	73,50	

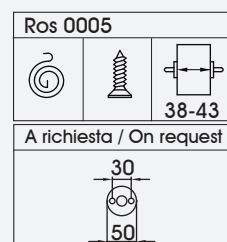
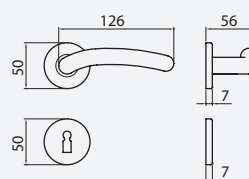
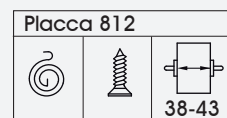
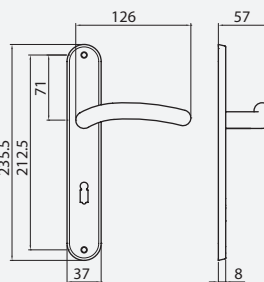

ZNS



GCTOL



ZCL



ZCS

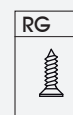
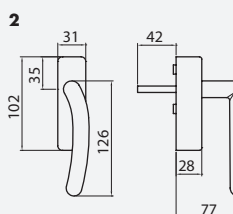
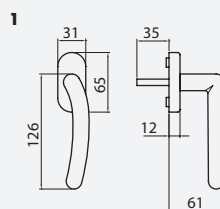

Per maggiori informazioni - For more information:



	ZCL	GCTOL	ZCS	ZNS	Conf. pz.
774/812 Q8 BB72 VL Guarnitura Q8 placca BB 72 con viti legno <i>Lever handle Q8 on key plate 72 with wood screw</i>	R077408127307	R077408127312	R077408127313	R077408127327	1
	34,70	32,70	34,70	35,30	
774/812 Q8 PZ72 VL Guarnitura Q8 placca Yale 72 con viti legno <i>Lever handle Q8 on cyl. plate 72 with wood screw</i>	R077408127707	R077408127712	R077408127713	R077408127727	1
	34,70	32,70	34,70	35,30	
774/812 Q8 WC78 Q8 VL Guarnitura Q8 placca WC 78 Q8 viti legno <i>Lever handle Q8 on WC Q8 function plate 78 with wood screw</i>	R077408129807	R077408129812	R077408129813	R077408129827	1
	45,30	43,30	45,30	46,70	
774/0005 Q8 R VL Guarnitura Q8 ros. senza bocc. con viti legno <i>Lever handle Q8 on rose with wood screw</i>	R07740005050760	R07740005051260	R07740005051360	R07740005052760	1
	20,05	20,25	20,05	20,55	
774/0005 Q8 RB BB VL Guarnitura Q8 ros./bocc. BB con viti legno <i>Lever handle Q8 on rose-key escutcheon with wood screw</i>	R07740005120760	R07740005121260	R07740005121360	R07740005122760	1
	23,55	23,25	23,55	24,25	
774/0005 Q8 RB PZ VL Guarnitura Q8 ros./bocc. Yale con viti legno <i>Lever handle Q8 on rose-cyl escutcheon with wood screw</i>	R07740005500760	R07740005501260	R07740005501360	R07740005502760	1
	23,55	23,25	23,55	24,25	
774/0005 Q8 RB WC Q8 VL Guarnitura Q8 ros./bocc. WC Q8 con viti legno <i>Lever handle Q8 on rose-WC Q8 function with wood screw</i>	R07740005880760	R07740005881260	R07740005881360	R07740005882760	1
	34,25	33,85	34,25	35,75	
774/0005 Q8 R C/BUSS. VPA Guarnitura Q8 ros. senza bocc. con buss. viti passanti autofilettanti <i>Lever handle Q8 on rose with pins / thread forming screw</i>	R077400050507	R077400050512	R077400050513	R077400050527	1
	20,30	20,50	20,30	20,80	
774/0005 Q8 RB BB C/BUSS. VPA Guarnitura Q8 ros./bocc. BB con buss. viti passanti autofilettanti <i>Lever handle Q8 on rose-key escutcheon with pins / thread forming screw</i>	R077400051207	R077400051212	R077400051213	R077400051227	1
	23,80	23,50	23,80	24,50	
774/0005 Q8 RB PZ C/BUSS. VPA Guarnitura Q8 ros./bocc. Yale con buss. viti passanti autofilettanti <i>Lever handle Q8 on rose-cyl escutcheon with pins / thread forming screw</i>	R077400055007	R077400055012	R077400055013	R077400055027	1
	23,80	23,50	23,80	24,50	
774/0005 Q8 RB WC Q8 C/BUSS. VPA Guarnitura Q8 ros./bocc. WC Q8 con buss. viti passanti autofilettanti <i>Lever handle Q8 on rose-WC Q8 function with pins / thread forming screw</i>	R077400058807	R077400058812	R077400058813	R077400058827	1
	34,50	34,10	34,50	36,00	
774/0004 DK x 35 VM C/BUSS. 1 Martellina DK Q7 x 35 con bussole D.9,5 mm viti metriche <i>Window handle Q7 DK-tilt & turn handle with pins D.9,5 / metric-thread screw</i>	R07740004800790	R07740004801290	R07740004801390	R07740004802790	1
	14,00	13,90	14,00	14,20	
774/00A4 DK x 42 C/CHIAVE VM C/BUSS. 2 Martellina con chiave DK Q7 x 42 con bussole D.9,5 mm viti metriche <i>Window handle Q7 DK-tilt & turn handle with key with pins D.9,5 / metric-thread screw</i>	R077400A4840790	R077400A4841290	R077400A4841390	R077400A4842790	1
	66,70	66,60	66,70	69,40	



OCS-M18

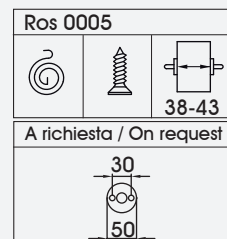
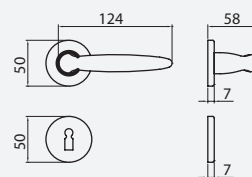
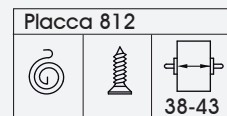
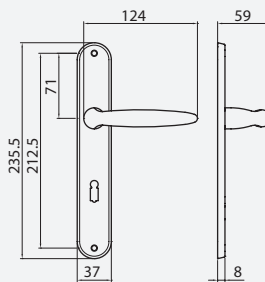

OLV-M1



OCL-M4



ONS-M9

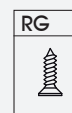
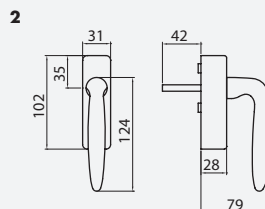
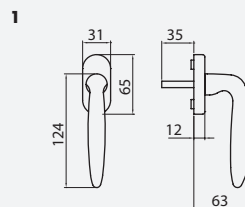

Per maggiori informazioni - For more information:



	OLV M1	OCS M18	OCL M4	ONS M9	Conf. pz.
775/812 Q8 BB72 VL Guarnitura Q8 placca BB 72 con viti legno <i>Lever handle Q8 on key plate 72 with wood screw</i>	R077508127301	R077508127303	R077508127307	R077508127327	1
	45,20	48,30	48,30	50,20	
775/812 Q8 PZ72 VL Guarnitura Q8 placca Yale 72 con viti legno <i>Lever handle Q8 on cyl. plate 72 with wood screw</i>	R077508127701	R077508127703	R077508127707	R077508127727	1
	45,20	48,30	48,30	50,20	
775/812 Q8 WC78 Q8 VL Guarnitura Q8 placca WC 78 Q8 viti legno <i>Lever handle Q8 on WC Q8 function plate 78 with wood screw</i>	R077508129801	R077508129803	R077508129807	R077508129827	1
	55,70	59,00	59,00	61,60	
775/0005 Q8 R VL Guarnitura Q8 ros. senza bocc. con viti legno <i>Lever handle Q8 on rose with wood screw</i>	R07750005050160	R07750005050360	R07750005050760	R07750005052760	1
	32,55	33,75	33,75	35,45	
775/0005 Q8 RB BB VL Guarnitura Q8 ros./bocc. BB con viti legno <i>Lever handle Q8 on rose-key escutcheon with wood screw</i>	R07750005120160	R07750005120360	R07750005120760	R07750005122760	1
	35,75	37,25	37,25	39,15	
775/0005 Q8 RB PZ VL Guarnitura Q8 ros./bocc. Yale con viti legno <i>Lever handle Q8 on rose-cyl escutcheon with wood screw</i>	R07750005500160	R07750005500360	R07750005500760	R07750005502760	1
	35,75	37,25	37,25	39,15	
775/0005 Q8 RB WC Q8 VL Guarnitura Q8 ros./bocc. WC Q8 con viti legno <i>Lever handle Q8 on rose-WC Q8 function with wood screw</i>	R07750005880160	R07750005880360	R07750005880760	R07750005882760	1
	46,35	48,15	48,15	50,65	
775/0005 Q8 R C/BUSS. VPA Guarnitura Q8 ros. senza bocc. con buss. viti passanti autofilettanti <i>Lever handle Q8 on rose with pins / thread forming screw</i>	R077500050501	R077500050503	R077500050507	R077500050527	1
	32,80	34,00	34,00	35,70	
775/0005 Q8 RB BB C/BUSS. VPA Guarnitura Q8 ros./bocc. BB con buss. viti passanti autofilettanti <i>Lever handle Q8 on rose-key escutcheon with pins / thread forming screw</i>	R077500051201	R077500051203	R077500051207	R077500051227	1
	36,00	37,50	37,50	39,40	
775/0005 Q8 RB PZ C/BUSS. VPA Guarnitura Q8 ros./bocc. Yale con buss. viti passanti autofilettanti <i>Lever handle Q8 on rose-cyl escutcheon with pins / thread forming screw</i>	R077500055001	R077500055003	R077500055007	R077500055027	1
	36,00	37,50	37,50	39,40	
775/0005 Q8 RB WC Q8 C/BUSS. VPA Guarnitura Q8 ros./bocc. WC Q8 con buss. viti passanti autofilettanti <i>Lever handle Q8 on rose-WC Q8 function with pins / thread forming screw</i>	R077500058801	R077500058803	R077500058807	R077500058827	1
	46,60	48,40	48,40	50,90	
775/0004 DK x 35 VM C/BUSS. 1 Martellina DK Q7 x 35 con bussole D.9,5 mm viti metriche <i>Window handle Q7 DK-tilt & turn handle with pins D.9,5 / metric-thread screw</i>	R07750004800190	R07750004800390	R07750004800790	R07750004802790	1
	20,20	20,90	20,90	21,70	
775/00A4 DK x 42 C/CHIAVE VM C/BUSS. 2 Martellina con chiave DK Q7 x 42 con bussole D.9,5 mm viti metriche <i>Window handle Q7 DK-tilt & turn handle with key with pins D.9,5 / metric-thread screw</i>	R077500A4840190	R077500A4840390	R077500A4840790	R077500A4842790	1
	73,10	73,50	73,50	76,50	



OCL-M4

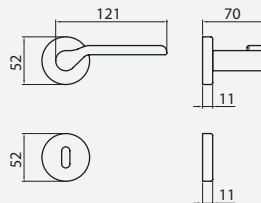

Ros 575		
		38-43



OCS-M18



ONS-M9

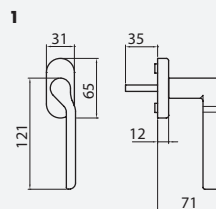

DK-1F

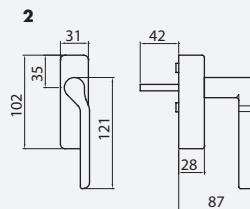

RG

Per maggiori informazioni - For more information:

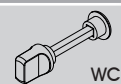

	OCS M18	OCL M4	ONS M9	Conf. pz.
904/575 Q8 R VL Guarnitura Q8 ros. senza bocc. con viti legno <i>Lever handle Q8 on rose with wood screw</i>	R09040575050360	R09040575050760	R09040575052760	1
	32,50	32,50	33,50	
904/575 Q8 RB BB VL Guarnitura Q8 ros./bocc. BB con viti legno <i>Lever handle Q8 on rose-key escutcheon with wood screw</i>	R09040575100360	R09040575100760	R09040575102760	1
	66,65	66,65	68,65	
904/575 Q8 RB PZ VL Guarnitura Q8 ros./bocc. Yale con viti legno <i>Lever handle Q8 on rose-cyl escutcheon with wood screw</i>	R09040575500360	R09040575500760	R09040575502760	1
	66,65	66,65	68,65	
904/575 Q8 RB WC Q8 VL Guarnitura Q8 ros./bocc. WC Q8 con viti legno <i>Lever handle Q8 on rose-WC Q8 function with wood screw</i>	R09040575880360	R09040575880760	R09040575882760	1
	74,05	74,05	76,05	
904/575 Q8 R C/BUSS. VPA Guarnitura Q8 ros. senza bocc. con buss. viti passanti autofilettanti <i>Lever handle Q8 on rose with pins / thread forming screw</i>	R090405750503	R090405750507	R090405750527	1
	32,75	32,75	33,75	
904/575 Q8 RB BB C/BUSS. VPA Guarnitura Q8 ros./bocc. BB con buss. viti passanti autofilettanti <i>Lever handle Q8 on rose-key escutcheon with pins / thread forming screw</i>	R090405751003	R090405751007	R090405751027	1
	66,90	66,90	68,90	
904/575 Q8 RB PZ C/BUSS. VPA Guarnitura Q8 ros./bocc. Yale con buss. viti passanti autofilettanti <i>Lever handle Q8 on rose-cyl escutcheon with pins / thread forming screw</i>	R090405755003	R090405755007	R090405755027	1
	66,90	66,90	68,90	
904/575 Q8 RB WC Q8 C/BUSS. VPA Guarnitura Q8 ros./bocc. WC Q8 con buss. viti passanti autofilettanti <i>Lever handle Q8 on rose-WC Q8 function with pins / thread forming screw</i>	R090405758803	R090405758807	R090405758827	1
	74,30	74,30	76,30	
904/0004 DK x 35 VM C/BUSS. 1 Martellina DK Q7 x 35 con bussole D.9,5 mm viti metriche <i>Window handle Q7 DK-tilt & turn handle with pins D.9,5 / metric-thread screw</i>	R09040004800390	R09040004800790	R09040004802790	1
	33,00	33,00	34,00	
904/00A4 DK x 42 C/CHIAVE VM C/BUSS. 2 Martellina con chiave DK Q7 x 42 con bussole D.9,5 mm viti metriche <i>Window handle Q7 DK-tilt & turn handle with key with pins D.9,5 / metric-thread screw</i>	R090400A4840390	R090400A4840790	R090400A4842790	1
	85,60	85,60	89,00	



ZCL/ZCS

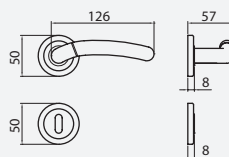

Ros 545		
		38-43
A richiesta / On request		



ZNL/ZNS

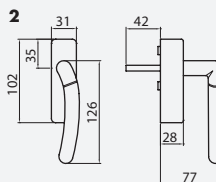
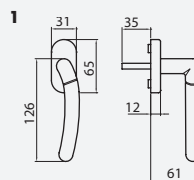

Per maggiori informazioni - For more information:



	ZNL/ZNS	ZCL/ZCS	Conf. pz.
923/545 Q8 R VL Guarnitura Q8 ros. senza bocc. con viti legno <i>Lever handle Q8 on rose with wood screw</i>	R09230545055760 24,25	R09230545055960 23,25	1
923/545 Q8 RB BB VL Guarnitura Q8 ros./bocc. BB con viti legno <i>Lever handle Q8 on rose-key escutcheon with wood screw</i>	R09230545105760 29,05	R09230545105960 27,75	1
923/545 Q8 RB PZ VL Guarnitura Q8 ros./bocc. Yale con viti legno <i>Lever handle Q8 on rose-cyl escutcheon with wood screw</i>	R09230545505760 29,05	R09230545505960 27,75	1
923/545 Q8 RB WC Q8 VL Guarnitura Q8 ros./bocc. WC Q8 con viti legno <i>Lever handle Q8 on rose-WC Q8 function with wood screw</i>	R09230545885760 39,75	R09230545885960 38,35	1
923/545 Q8 R C/BUSS. VPA Guarnitura Q8 ros. senza bocc. con buss. viti passanti autofilettanti <i>Lever handle Q8 on rose with pins / thread forming screw</i>	R092305450557 24,50	R092305450559 23,50	1
923/545 Q8 RB BB C/BUSS. VPA Guarnitura Q8 ros./bocc. BB con buss. viti passanti autofilettanti <i>Lever handle Q8 on rose-key escutcheon with pins / thread forming screw</i>	R092305451057 29,30	R092305451059 28,00	1
923/545 Q8 RB PZ C/BUSS. VPA Guarnitura Q8 ros./bocc. Yale con buss. viti passanti autofilettanti <i>Lever handle Q8 on rose-cyl escutcheon with pins / thread forming screw</i>	R092305455057 29,30	R092305455059 28,00	1
923/545 Q8 RB WC Q8 C/BUSS. VPA Guarnitura Q8 ros./bocc. WC Q8 con buss. viti passanti autofilettanti <i>Lever handle Q8 on rose-WC Q8 function with pins / thread forming screw</i>	R092305458857 40,00	R092305458859 38,60	1
923/0004 DK x 35 VM C/BUSS. 1 Martellina DK Q7 x 35 con bussole D.9,5 mm viti metriche <i>Window handle Q7 DK-tilt & turn handle with pins D.9,5 / metric-thread screw</i>	R09230004805790 15,80	R09230004805990 15,10	1
923/00A4 DK x 42 C/CHIAVE VM C/BUSS. 2 Martellina con chiave DK Q7 x 42 con bussole D.9,5 mm viti metriche <i>Window handle Q7 DK-tilt & turn handle with key with pins D.9,5 / metric-thread screw</i>	R092300A4845790 68,20	R092300A4845990 67,80	1



OCS-M18

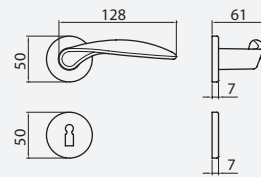

Ros 0005		
A richiesta / On request		



OLV-M1



OCL-M4



ONS-M9

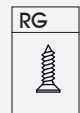
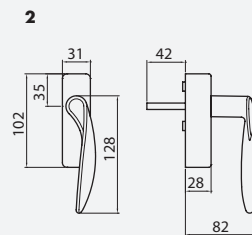
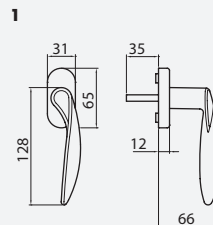

Per maggiori informazioni - For more information:



	OLV M1	OCS M18	OCL M4	ONS M9	Conf. pz.
938/0005 Q8 R VL Guarnitura Q8 ros. senza bocc. con viti legno <i>Lever handle Q8 on rose with wood screw</i>	R09380005050160	R09380005050360	R09380005050760	R09380005052760	1
	36,35	37,55	37,55	39,25	
938/0005 Q8 RB BB VL Guarnitura Q8 ros./bocc. BB con viti legno <i>Lever handle Q8 on rose-key escutcheon with wood screw</i>	R09380005120160	R09380005120360	R09380005120760	R09380005122760	1
	39,55	41,15	41,15	43,15	
938/0005 Q8 RB PZ VL Guarnitura Q8 ros./bocc. Yale con viti legno <i>Lever handle Q8 on rose-cyl escutcheon with wood screw</i>	R09380005500160	R09380005500360	R09380005500760	R09380005502760	1
	39,55	41,15	41,15	43,15	
938/0005 Q8 RB WC Q8 VL Guarnitura Q8 ros./bocc. WC Q8 con viti legno <i>Lever handle Q8 on rose-WC Q8 function with wood screw</i>	R09380005880160	R09380005880360	R09380005880760	R09380005882760	1
	50,05	52,05	52,05	54,65	
938/0005 Q8 R C/BUSS. VPA Guarnitura Q8 ros. senza bocc. con buss. viti passanti autofilettanti <i>Lever handle Q8 on rose with pins / thread forming screw</i>	R093800050501	R093800050503	R093800050507	R093800050527	1
	36,60	37,80	37,80	39,50	
938/0005 Q8 RB BB C/BUSS. VPA Guarnitura Q8 ros./bocc. BB con buss. viti passanti autofilettanti <i>Lever handle Q8 on rose-key escutcheon with pins / thread forming screw</i>	R093800051201	R093800051203	R093800051207	R093800051227	1
	39,80	41,40	41,40	43,40	
938/0005 Q8 RB PZ C/BUSS. VPA Guarnitura Q8 ros./bocc. Yale con buss. viti passanti autofilettanti <i>Lever handle Q8 on rose-cyl escutcheon with pins / thread forming screw</i>	R093800055001	R093800055003	R093800055007	R093800055027	1
	39,80	41,40	41,40	43,40	
938/0005 Q8 RB WC Q8 C/BUSS. VPA Guarnitura Q8 ros./bocc. WC Q8 con buss. viti passanti autofilettanti <i>Lever handle Q8 on rose-WC Q8 function with pins / thread forming screw</i>	R093800058801	R093800058803	R093800058807	R093800058827	1
	50,30	52,30	52,30	54,90	
938/0004 DK x 35 VM C/BUSS. 1 Martellina DK Q7 x 35 con bussole D.9,5 mm viti metriche <i>Window handle Q7 DK-tilt & turn handle with pins D.9,5 / metric-thread screw</i>	R09380004800190	R09380004800390	R09380004800790	R09380004802790	1
	22,00	22,80	22,80	23,60	
938/00A4 DK x 42 C/CHIAVE VM C/BUSS. 2 Martellina con chiave DK Q7 x 42 con bussole D.9,5 mm viti metriche <i>Window handle Q7 DK-tilt & turn handle with key with pins D.9,5 / metric-thread screw</i>	R093800A4840190	R093800A4840390	R093800A4840790	R093800A4842790	1
	74,90	75,60	75,60	78,65	

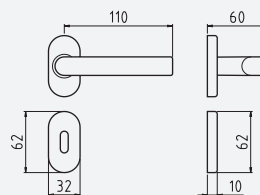
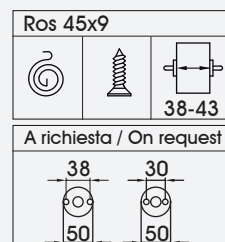
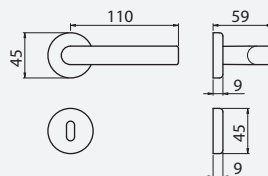

ZCS



ZCL



ZNS

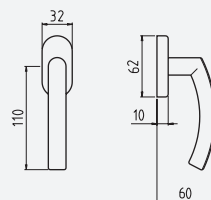
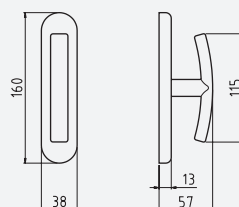

Per maggiori informazioni - For more information:

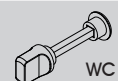

	ZCL	ZCS	ZNS	Conf. pz.
Q8 R	66092280507	66092280513	66092280527	
Guarnitura Q8 ros. senza bocc.				1
<i>Lever handle Q8 on rose</i>	15,60	15,60	16,40	
Q8 RB	66092281507	66092281513	66092281527	
Guarnitura Q8 ros./bocc. patent				1
<i>Lever handle Q8 on rose-key escutcheon</i>	19,80	19,80	21,10	
Q8 RBY	66092285507	66092285513	66092285527	
Guarnitura Q8 ros./bocc. Yale				1
<i>Lever handle Q8 on rose-cyl escutcheon</i>	19,80	19,80	21,10	
Q8 RBWC	66092288007	66092288013	66092288027	
Guarnitura Q8 ros./bocc.Wc				1
<i>Lever handle Q8 on rose-WC function</i>	25,80	25,80	27,10	
Q8 ROC	66092220507	66092220513	66092220527	
Guarnitura Q8 ros.ovale senza bocc.				1
<i>Lever handle Q8 on oval rose</i>	17,20	17,20	18,10	
Q8 RBOC	66092221507	66092221513	66092221527	
Guarnitura Q8 ros/bocc.ovale patent				1
<i>Lever handle Q8 on oval rose-key escutcheon</i>	21,80	21,80	23,20	
Q8 RBOYC	66092225507	66092225513	66092225527	
Guarnitura Q8 ros/bocc.ovale Yale				1
<i>Lever handle Q8 on oval rose-cyl escutcheon</i>	21,80	21,80	23,20	
EZ BELLAIDEA	66094406007	66094406013	66094406027	
Cremonese gioco EZ				2
<i>Window handle Q7 with mechanism</i>	16,80	16,80	17,20	
EZQ7 BELLAIDEA	66094407007	66094407013	66094407027	
Cremonese gioco EZ + Q7				2
<i>Window handle Q7 with mechanism</i>	17,20	17,20	17,60	
MART BELLAIDEA	66094500007	66094500013	66094500027	
Martellina Q7				2
<i>Window handle Q7</i>	16,80	16,80	17,20	
DK x 40-35	66092577007	66092577013	66092577027	
Martellina DK Q7 x 40-35				2
<i>Window handle Q7 DK-tilt & turn handle</i>	9,30	9,30	9,90	
DK x 40-35 C/BUSS.	66092578007	66092578013	66092578027	
Martellina DK Q7 x 40-35 con bussole				2
<i>Window handle Q7 DK-tilt & turn handle with pins</i>	9,30	9,30	9,90	

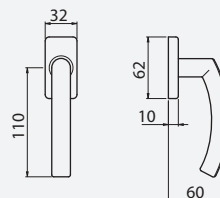
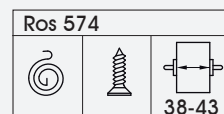
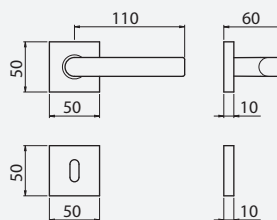

ZCS



ZCL



ZNS



Per maggiori informazioni - For more information:



	ZCL	ZCS	ZNS	Conf. pz.
Q8 RQ	66080280507	66080280513	66080280527	
Guarnitura Q8 ros. senza bocc.				1
<i>Lever handle Q8 on rose</i>	17,90	17,90	23,90	
Q8 RBQ	66080281507	66080281513	66080281527	
Guarnitura Q8 ros./bocc. patent				1
<i>Lever handle Q8 on rose-key escutcheon</i>	25,80	25,80	31,80	
Q8 RBQY	66080285507	66080285513	66080285527	
Guarnitura Q8 ros./bocc. Yale				1
<i>Lever handle Q8 on rose-cyl escutcheon</i>	25,80	25,80	31,80	
Q8 RBQWC	66080288007	66080288013	66080288027	
Guarnitura Q8 ros./bocc.Wc				1
<i>Lever handle Q8 on rose-WC function</i>	31,80	31,80	37,80	
DK x 40-35	66080577007	66080577013	66080577027	
Martellina DK Q7 x 40-35				2
<i>Window handle Q7 DK-tilt & turn handle</i>	10,00	10,00	10,60	
DK x 40-35 C/BUSS.	66080578007	66080578013	66080578027	
Martellina DK Q7 x 40-35 con bussole				2
<i>Window handle Q7 DK-tilt & turn handle with pins</i>	10,00	10,00	10,60	



ZCL

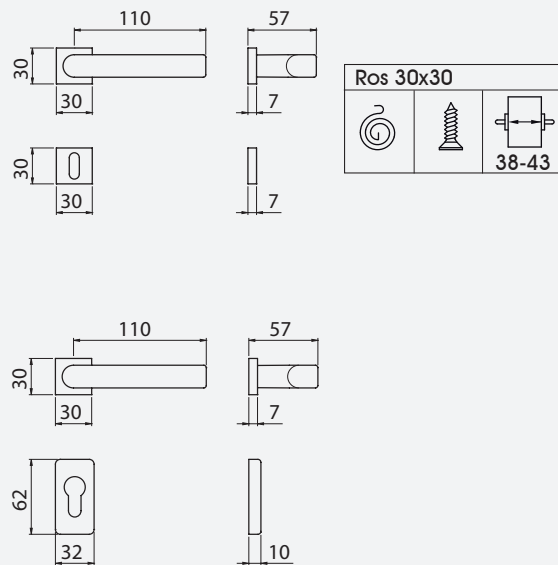

ZCS

Per maggiori informazioni - For more information:

	ZCL	ZCS	Conf. pz.
Q8 RBQ 30x30	66080261607	66080261613	
Guarnitura Q8 ros./bocc. quadra patent			1
<i>Lever handle Q8 on rose-key escutcheon</i>	27,10	27,10	

Q8 RQ 30x30 BRettY 30x60	66080265607	66080265613	
Guarnitura Q8 ros.quadra bocc.rettangolare Yale			1
<i>Lever handle Q8 on rose-cyl escutcheon</i>	30,70	30,70	

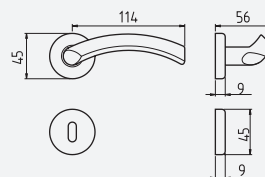

Ros 45x9		
		38-43
A richiesta / On request		
38	30	
50	50	

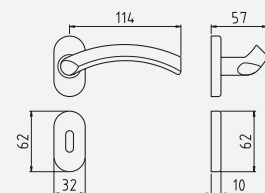

Ros 0006		
		38-43

ZCL



ZCS



ZNS

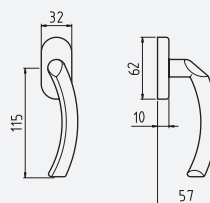
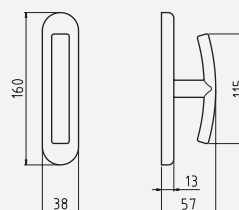

Per maggiori informazioni - For more information:

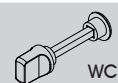

	ZCL	ZCS	ZNS	Conf. pz.
Q8 R	66094280507	66094280513	66094280527	
Guarnitura Q8 ros. senza bocc.				1
<i>Lever handle Q8 on rose</i>	15,60	15,60	16,40	
Q8 RB	66094281507	66094281513	66094281527	
Guarnitura Q8 ros./bocc. patent				1
<i>Lever handle Q8 on rose-key escutcheon</i>	19,80	19,80	21,10	
Q8 RBY	66094285507	66094285513	66094285527	
Guarnitura Q8 ros./bocc. Yale				1
<i>Lever handle Q8 on rose-cyl escutcheon</i>	19,80	19,80	21,10	
Q8 RBWC	66094288007	66094288013	66094288027	
Guarnitura Q8 ros./bocc.Wc				1
<i>Lever handle Q8 on rose-WC function</i>	25,80	25,80	27,10	
Q8 ROC	66094220507	66094220513	66094220527	
Guarnitura Q8 ros.ovale senza bocc.				1
<i>Lever handle Q8 on oval rose</i>	17,20	17,20	18,10	
Q8 RBOC	66094221507	66094221513	66094221527	
Guarnitura Q8 ros/bocc.ovale patent				1
<i>Lever handle Q8 on oval rose-key escutcheon</i>	21,80	21,80	23,20	
Q8 RBOYC	66094225507	66094225513	66094225527	
Guarnitura Q8 ros/bocc.ovale Yale				1
<i>Lever handle Q8 on oval rose-cyl escutcheon</i>	21,80	21,80	23,20	
EZ BELLAIDEA	66094406007	66094406013	66094406027	
Cremonese gioco EZ				2
<i>Window handle Q7 with mechanism</i>	16,80	16,80	17,20	
EZQ7 BELLAIDEA	66094407007	66094407013	66094407027	
Cremonese gioco EZ + Q7				2
<i>Window handle Q7 with mechanism</i>	17,20	17,20	17,60	
MART BELLAIDEA	66094500007	66094500013	66094500027	
Martellina Q7				2
<i>Window handle Q7</i>	16,80	16,80	17,20	
DK x 40	66094557007	66094557013	66094557027	
Martellina DK Q7 x 40				2
<i>Window handle Q7 DK-tilt & turn handle</i>	9,30	9,30	9,90	
DK x 40 C/BUSS.	66094558007	66094558013	66094558027	
Martellina DK Q7 x 40 con bussole				2
<i>Window handle Q7 DK-tilt & turn handle with pins</i>	9,30	9,30	9,90	

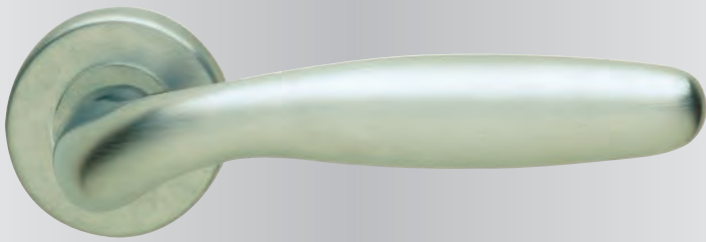

OCS-M18

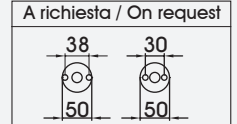
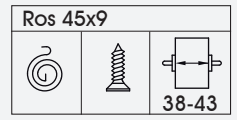
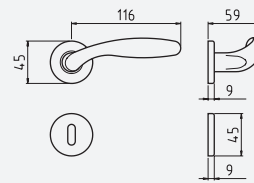
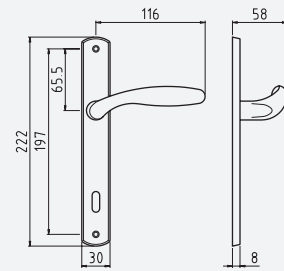
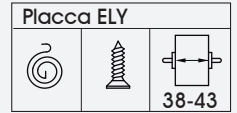
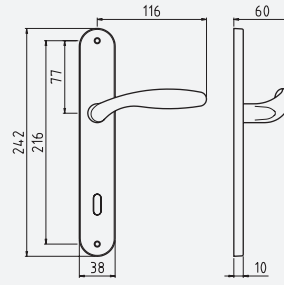

OLV-M1



OCL-M4

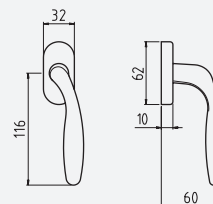
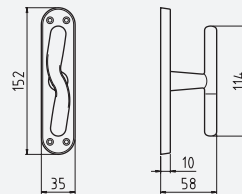
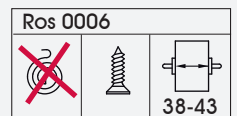
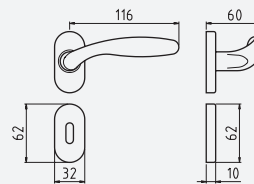

Per maggiori informazioni - For more information:

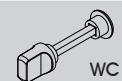

	OLV M1	OCS M18	OCL M4	Conf. pz.	Imb. pz.
Q8 P90	55040089001	55040089003	55040089007		
Guarnitura Q8 placca patent 90	26,70	33,50	33,50	1	20
<i>Lever handle Q8 on key plate 90</i>					
Q8 P70	55040087001	55040087003	55040087007		
Guarnitura Q8 placca patent 70	26,70	33,50	33,50	1	20
<i>Lever handle Q8 on key plate 70</i>					
Q8 PY85	55040088501	55040088503	55040088507		
Guarnitura Q8 placca yale 85	26,70	33,50	33,50	1	20
<i>Lever handle Q8 on cyl. plate 85</i>					
Q8 P90RS	55040051001	55040051003	55040051007		
Guarnitura Q8 placca stretta pat 90	29,30	36,90	36,90	1	-
<i>Lever handle Q8 on reduced key plate 90</i>					
Q8 P70RS	55040057001	55040057003	55040057007		
Guarnitura Q8 placca stretta pat 70	29,30	36,90	36,90	1	-
<i>Lever handle Q8 on reduced key plate 70</i>					
Q8 PY85RS	55040055001	55040055003	55040055007		
Guarnitura Q8 placca stretta yale85	29,30	36,90	36,90	1	-
<i>Lever handle Q8 on reduced cyl. plate 85</i>					
Q8 R	55040280001	55040280003	55040280007		
Guarnitura Q8 ros. senza bocc.	20,80	26,30	26,30	1	50
<i>Lever handle Q8 on rose</i>					
Q8 RB	55040281001	55040281003	55040281007		
Guarnitura Q8 ros./bocc. patent	24,90	31,80	31,80	1	50
<i>Lever handle Q8 on rose-key escutcheon</i>					
Q8 RBY	55040285001	55040285003	55040285007		
Guarnitura Q8 ros./bocc. Yale	24,90	31,80	31,80	1	50
<i>Lever handle Q8 on rose-cyl escutcheon</i>					
Q8 RBWC	55040288001	55040288003	55040288007		
Guarnitura Q8 ros./bocc.Wc	31,80	41,40	41,40	1	50
<i>Lever handle Q8 on rose-WC function</i>					
Q8 ROC	55040220501	55040220503	55040220507		
Guarnitura Q8 ros.ovale senza bocc.	22,90	29,00	29,00	1	-
<i>Lever handle Q8 on oval rose</i>					
Q8 RBOC	55040221501	55040221503	55040221507		
Guarnitura Q8 ros/bocc.ovale patent	27,50	35,00	35,00	1	-
<i>Lever handle Q8 on oval rose-key escutcheon</i>					
Q8 RBOYC	55040225501	55040225503	55040225507		
Guarnitura Q8 ros/bocc.ovale Yale	27,50	35,00	35,00	1	-
<i>Lever handle Q8 on oval rose-cyl escutcheon</i>					
EZ	55040406001	55040406003	55040406007		
Cremonese gioco EZ	17,40	20,80	20,80	2	100
<i>Window handle Q7 with mechanism</i>					
EZQ7	55040407001	55040407003	55040407007		
Cremonese gioco EZ + Q7	17,90	21,30	21,30	2	100
<i>Window handle Q7 with mechanism</i>					
MART	55040500001	55040500003	55040500007		
Martellina Q7	16,70	20,20	20,20	2	100
<i>Window handle Q7</i>					
DK x 40	55040557001	55040557003	55040557007		
Martellina DK Q7 x 40	17,40	20,80	20,80	2	100
<i>Window handle Q7 DK-tilt & turn handle</i>					
DK x 40 C/BUSS.	55040558001	55040558003	55040558007		
Martellina DK Q7 x 40 con bussole D. 9,5	17,40	20,80	20,80	2	100
<i>Window handle Q7 DK-tilt & turn handle with pins D. 9,5</i>					



OCS-M18

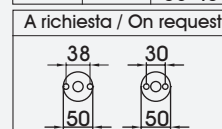
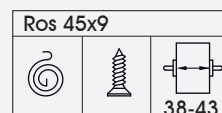
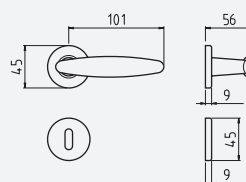
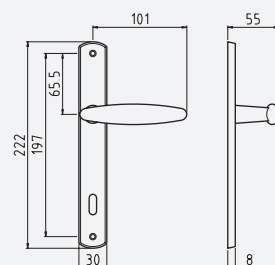
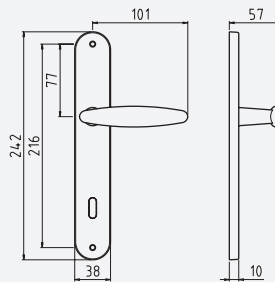

OLV-M1



OCL-M4

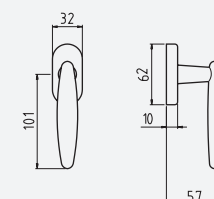
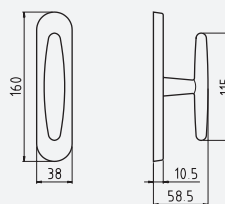
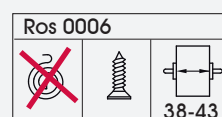
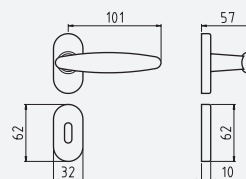

Per maggiori informazioni - For more information:

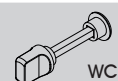

	OLV M1	OCS M18	OCL M4	Conf. pz.	Imb. pz.
Q8 P90	55038089001	55038089003	55038089007		
Guarnitura Q8 placca patent 90				1	20
<i>Lever handle Q8 on key plate 90</i>	39,60	46,60	46,60		
Q8 P70	55038087001	55038087003	55038087007		
Guarnitura Q8 placca patent 70				1	20
<i>Lever handle Q8 on key plate 70</i>	39,60	46,60	46,60		
Q8 PY85	55038088501	55038088503	55038088507		
<i>Guarnitura Q8 placca yale 85</i>				1	20
Lever handle Q8 on cyl. plate 85	39,60	46,60	46,60		
Q8 P90RS	55038051001	55038051003	55038051007		
Guarnitura Q8 placca stretta pat 90				1	-
<i>Lever handle Q8 on reduced key plate 90</i>	43,60	51,30	51,30		
Q8 P70RS	55038057001	55038057003	55038057007		
Guarnitura Q8 placca stretta pat 70				1	-
<i>Lever handle Q8 on reduced key plate 70</i>	43,60	51,30	51,30		
Q8 PY85RS	55038055001	55038055003	55038055007		
Guarnitura Q8 placca stretta yale85				1	-
<i>Lever handle Q8 on reduced cyl. plate 85</i>	43,60	51,30	51,30		
Q8 R	55038280001	55038280003	55038280007		
Guarnitura Q8 ros. senza bocc.				1	50
<i>Lever handle Q8 on rose</i>	30,50	34,70	34,70		
Q8 RB	55038281001	55038281003	55038281007		
Guarnitura Q8 ros./bocc. patent				1	50
<i>Lever handle Q8 on rose-key escutcheon</i>	33,10	38,10	38,10		
Q8 RBY	55038285001	55038285003	55038285007		
Guarnitura Q8 ros./bocc. Yale				1	50
<i>Lever handle Q8 on rose-cyl escutcheon</i>	33,10	38,10	38,10		
Q8 RBWC	55038288001	55038288003	55038288007		
Guarnitura Q8 ros./bocc.Wc				1	50
<i>Lever handle Q8 on rose-WC function</i>	38,60	44,60	44,60		
Q8 ROC	55038220501	55038220503	55038220507		
Guarnitura Q8 ros.ovale senza bocc.				1	-
<i>Lever handle Q8 on oval rose</i>	33,50	38,10	38,10		
Q8 RBOC	55038221501	55038221503	55038221507		
Guarnitura Q8 ros/bocc.ovale patent				1	-
<i>Lever handle Q8 on oval rose-key escutcheon</i>	36,40	41,90	41,90		
Q8 RBOYC	55038225501	55038225503	55038225507		
Guarnitura Q8 ros/bocc.ovale Yale				1	-
<i>Lever handle Q8 on oval rose-cyl escutcheon</i>	36,40	41,90	41,90		
EZ	55038406001	55038406003	55038406007		
Cremonese gioco EZ				2	100
<i>Window handle Q7 with mechanism</i>	28,50	29,90	29,90		
EZQ7	55038407001	55038407003	55038407007		
Cremonese gioco EZ + Q7				2	100
<i>Window handle Q7 with mechanism</i>	29,30	30,80	30,80		
MART	55038500001	55038500003	55038500007		
Martellina Q7				2	100
<i>Window handle Q7</i>	28,50	29,90	29,90		
DK x 40	55038557001	55038557003	55038557007		
Martellina DK Q7 x 40				2	100
<i>Window handle Q7 DK-tilt & turn handle</i>	20,80	24,30	24,30		
DK x 40 C/BUSS.	55038558001	55038558003	55038558007		
Martellina DK Q7 x 40 con bussole D. 9,5				2	100
<i>Window handle Q7 DK-tilt & turn handle with pins D. 9,5</i>	20,80	24,30	24,30		

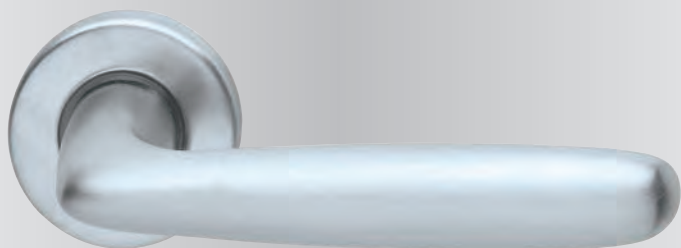

OCS-M18



OLV-M1



OCL-M4

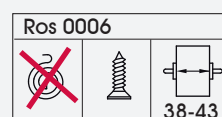
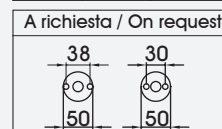
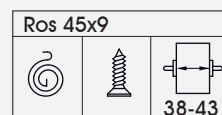
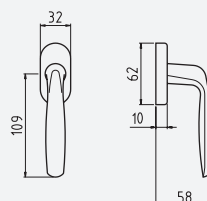
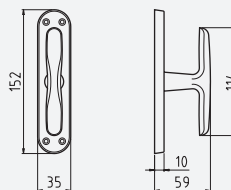
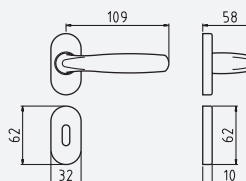
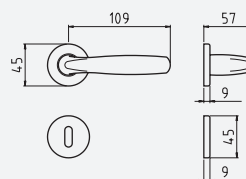
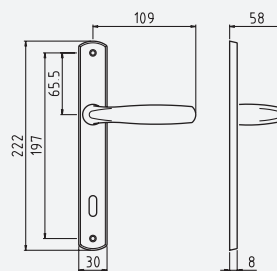
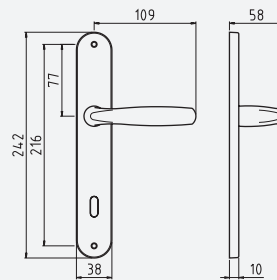

Per maggiori informazioni - For more information:

Rosette da pag. 246 a pag. 257
 Placche da pag. 265 a pag. 267
 DK da pag. 262 a pag. 264

Roses from pag. 246 to pag. 257
 Plates from pag. 265 to pag. 267
 Window handles from pag. 262 to pag. 264

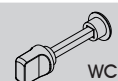

	OLV M1	OCS M18	OCL M4	Conf. pz.	Imb. pz.
Q8 P90 Guarnitura Q8 placca patent 90 <i>Lever handle Q8 on key plate 90</i>	55034089001 26,00	55034089003 32,80	55034089007 32,80	1	20
Q8 P70 Guarnitura Q8 placca patent 70 <i>Lever handle Q8 on key plate 70</i>	55034087001 26,00	55034087003 32,80	55034087007 32,80	1	20
Q8 PY85 Guarnitura Q8 placca yale 85 <i>Lever handle Q8 on cyl. plate 85</i>	55034088501 26,00	55034088503 32,80	55034088507 32,80	1	20
Q8 P90RS Guarnitura Q8 placca stretta pat 90 <i>Lever handle Q8 on reduced key plate 90</i>	55034051001 28,60	55034051003 36,10	55034051007 36,10	1	-
Q8 P70RS Guarnitura Q8 placca stretta pat 70 <i>Lever handle Q8 on reduced key plate 70</i>	55034057001 28,60	55034057003 36,10	55034057007 36,10	1	-
Q8 PY85RS Guarnitura Q8 placca stretta yale85 <i>Lever handle Q8 on reduced cyl. plate 85</i>	55034055001 28,60	55034055003 36,10	55034055007 36,10	1	-
Q8 R Guarnitura Q8 ros. senza bocc. <i>Lever handle Q8 on rose</i>	55034280001 20,20	55034280003 25,70	55034280007 25,70	1	50
Q8 RB Guarnitura Q8 ros./bocc. patent <i>Lever handle Q8 on rose-key escutcheon</i>	55034281001 24,30	55034281003 31,10	55034281007 31,10	1	50
Q8 RBY Guarnitura Q8 ros./bocc. Yale <i>Lever handle Q8 on rose-cyl escutcheon</i>	55034285001 24,30	55034285003 31,10	55034285007 31,10	1	50
Q8 RBWC Guarnitura Q8 ros./bocc.Wc <i>Lever handle Q8 on rose-WC function</i>	55034288001 31,10	55034288003 38,00	55034288007 38,00	1	50
Q8 ROC Guarnitura Q8 ros.ovale senza bocc. <i>Lever handle Q8 on oval rose</i>	55034220501 22,20	55034220503 28,20	55034220507 28,20	1	-
Q8 RBOC Guarnitura Q8 ros/bocc.ovale patent <i>Lever handle Q8 on oval rose-key escutcheon</i>	55034221501 26,70	55034221503 34,20	55034221507 34,20	1	-
Q8 RBOYC Guarnitura Q8 ros/bocc.ovale Yale <i>Lever handle Q8 on oval rose-cyl escutcheon</i>	55034225501 26,70	55034225503 34,20	55034225507 34,20	1	-
EZ Cremonese gioco EZ <i>Window handle Q7 with mechanism</i>	55034406001 16,70	55034406003 20,20	55034406007 20,20	2	100
EZQ7 Cremonese gioco EZ + Q7 <i>Window handle Q7 with mechanism</i>	55034407001 17,20	55034407003 20,60	55034407007 20,60	2	100
MART Martellina Q7 <i>Window handle Q7</i>	55034500001 16,10	55034500003 19,50	55034500007 19,50	2	100
DK x 40 Martellina DK Q7 x 40 <i>Window handle Q7 DK-tilt & turn handle</i>	55034557001 16,70	55034557003 20,20	55034557007 20,20	2	100
DK x 40 C/BUSS. Martellina DK Q7 x 40 con bussole D. 9,5 <i>Window handle Q7 DK-tilt & turn handle with pins D. 9,5</i>	55034558001 16,70	55034558003 20,20	55034558007 20,20	2	100

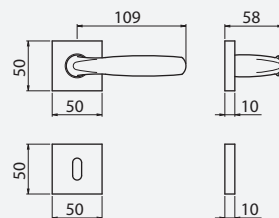
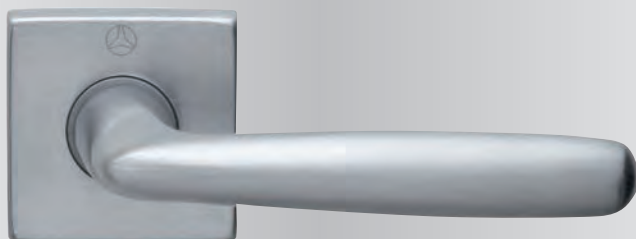

Ros 574		
		38-43

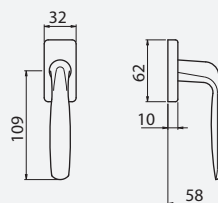

OCS-M18



OLV-M1



OCL-M4



Per maggiori informazioni - For more information:

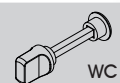

	OLV M1	OCS M18	OCL M4	Conf. pz.
Q8 RQ	55060280001	55060280003	55060280007	
Guarnitura Q8 ros. senza bocc.				1
<i>Lever handle Q8 on rose</i>	22,10	27,00	27,00	
Q8 RBQ	55060281001	55060281003	55060281007	
Guarnitura Q8 ros./bocc. patent				1
<i>Lever handle Q8 on rose-key escutcheon</i>	25,60	31,90	31,90	
Q8 RBQY	55060285001	55060285003	55060285007	
Guarnitura Q8 ros./bocc. Yale				1
<i>Lever handle Q8 on rose-cyl escutcheon</i>	25,60	31,90	31,90	
Q8 RBQWC	55060288001	55060288003	55060288007	
Guarnitura Q8 ros./bocc.Wc				1
<i>Lever handle Q8 on rose-WC function</i>	32,70	40,20	40,20	
DK x 40	55060557001	55060557003	55060557007	
Martellina DK Q7 x 40				2
<i>Window handle Q7 DK-tilt & turn handle</i>	16,70	20,20	20,20	
DK x 40 C/BUSS.	55060558001	55060558003	55060558007	
Martellina DK Q7 x 40 con bussole D. 9,5				2
<i>Window handle Q7 DK-tilt & turn handle with pins D. 9,5</i>	16,70	20,20	20,20	

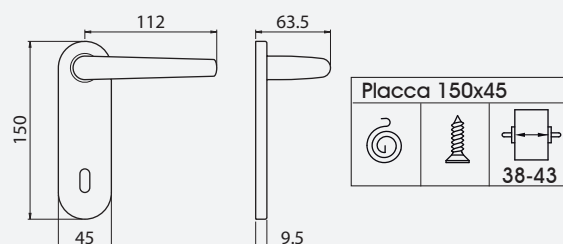

ZCS

	GCTOL	ZCL	ZCS	Conf. pz.
Q8 P90 150x45	66108089012	66108089007	66108089013	
Guarnitura Q8 placca mm 150x45 patent 90				1
<i>Lever handle Q8 on key plate 90</i>	24,90	27,80	27,80	
Q8 P70 150x45	66108087012	66108087007	66108087013	
Guarnitura Q8 placca mm 150x45 patent 70				1
<i>Lever handle Q8 on key plate 70</i>	24,90	27,80	27,80	
Q8 PY85 150x45	66108088512	66108088507	66108088513	
Guarnitura Q8 placca mm 150x45 yale 85				1
<i>Lever handle Q8 on cyl. plate 85</i>	24,90	27,80	27,80	

Per maggiori informazioni - For more information:

UNO Z



ZCS

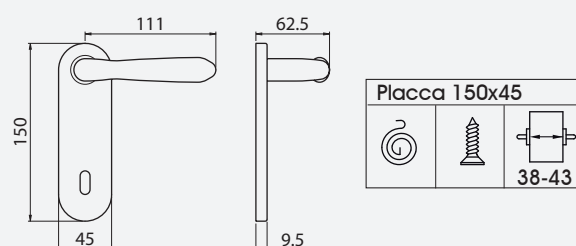

	GCTOL	ZCL	ZCS	Conf. pz.
Q8 P90 150x45	66110089012	66110089007	66110089013	
Guarnitura Q8 placca mm 150x45 patent 90				1
<i>Lever handle Q8 on key plate 90</i>	26,50	29,40	29,40	
Q8 P70 150x45	66110087012	66110087007	66110087013	
Guarnitura Q8 placca mm 150x45 patent 70				1
<i>Lever handle Q8 on key plate 70</i>	26,50	29,40	29,40	
Q8 PY85 150x45	66110088512	66110088507	66110088513	
Guarnitura Q8 placca mm 150x45 yale 85				1
<i>Lever handle Q8 on cyl. plate 85</i>	26,50	29,40	29,40	

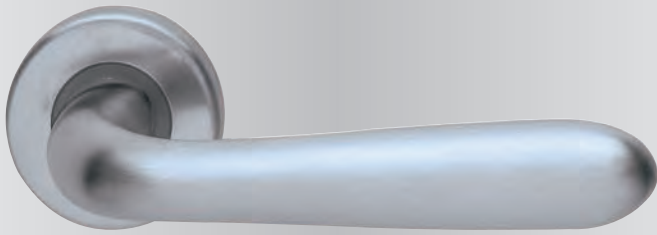

OCS-M18

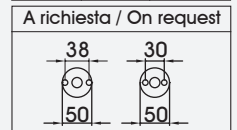
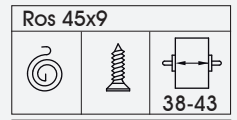
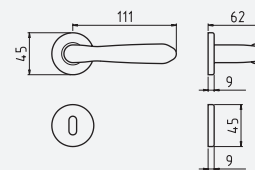
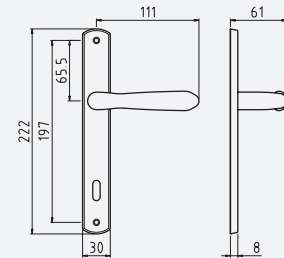
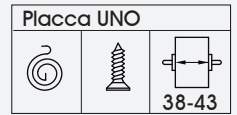
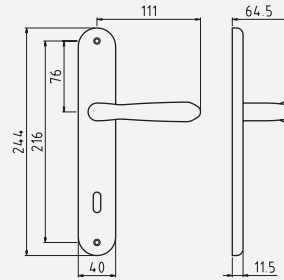

OLV-M1



OGV-M27



OCL-M4



G-PLUS-M36

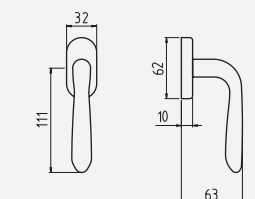
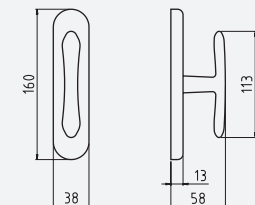
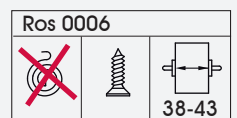
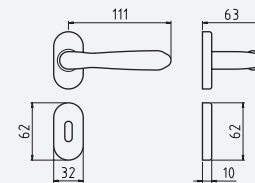

Per maggiori informazioni - For more information:

Rosette da pag. 246 a pag. 257 Roses from pag. 246 to pag. 257
 Placche da pag. 265 a pag. 267 Plates from pag. 265 to pag. 267
 DK da pag. 262 a pag. 264 Window handles from pag. 262 to pag. 264

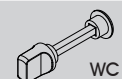

	OLV M1	OCS M18	OGV M27	OCL M4	G-PLUS M36	Conf. pz.	Imb. pz.
Q8 P90 Guarnitura Q8 placca patent 90 <i>Lever handle Q8 on key plate 90</i>	55796089001	55796089003	55796089004	55796089007	55796089050	1	20
	30,50	34,50	30,90	34,50	61,50		
Q8 P70 Guarnitura Q8 placca patent 70 <i>Lever handle Q8 on key plate 70</i>	55796087001	55796087003	55796087004	55796087007	55796087050	1	20
	30,50	34,50	30,90	34,50	61,50		
Q8 PY85 Guarnitura Q8 placca yale 85 <i>Lever handle Q8 on cyl. plate 85</i>	55796088501	55796088503	55796088504	55796088507	55796088550	1	20
	30,50	34,50	30,90	34,50	61,50		
Q8 P90RS Guarnitura Q8 placca stretta pat 90 <i>Lever handle Q8 on reduced key plate 90</i>	55796051001	55796051003	55796051004	55796051007	55796051050	1	-
	31,50	35,60	31,90	35,60	62,60		
Q8 P70RS Guarnitura Q8 placca stretta pat 70 <i>Lever handle Q8 on reduced key plate 70</i>	55796057001	55796057003	55796057004	55796057007	55796057050	1	-
	31,50	35,60	31,90	35,60	62,60		
Q8 PY85RS Guarnitura Q8 placca stretta yale85 <i>Lever handle Q8 on reduced cyl. plate 85</i>	55796055001	55796055003	55796055004	55796055007	55796055050	1	-
	31,50	35,60	31,90	35,60	62,60		
Q8 R Guarnitura Q8 ros. senza bocc. <i>Lever handle Q8 on rose</i>	55796280001	55796280003	55796280004	55796280007	55796280050	1	50
	21,40	23,90	22,20	23,90	42,70		
Q8 RB Guarnitura Q8 ros./bocc. patent <i>Lever handle Q8 on rose-key escutcheon</i>	55796281001	55796281003	55796281004	55796281007	55796281050	1	50
	24,00	29,40	24,80	29,40	54,70		
Q8 RBY Guarnitura Q8 ros./bocc. Yale <i>Lever handle Q8 on rose-cyl escutcheon</i>	55796285001	55796285003	55796285004	55796285007	55796285050	1	50
	24,00	29,40	24,80	29,40	54,70		
Q8 RBWC Guarnitura Q8 ros./bocc.Wc <i>Lever handle Q8 on rose-WC function</i>	55796288001	55796288003	55796288004	55796288007	55796288050	1	50
	29,40	39,00	31,60	39,00	70,40		
Q8 ROC Guarnitura Q8 ros.ovale senza bocc. <i>Lever handle Q8 on oval rose</i>	55796220501	55796220503	55796220504	55796220507	55796220550	1	-
	26,30	25,40	27,00	25,40	47,00		
Q8 RBOC Guarnitura Q8 ros/bocc.ovale patent <i>Lever handle Q8 on oval rose-key escutcheon</i>	55796221501	55796221503	55796221504	55796221507	55796221550	1	-
	28,20	32,30	28,50	32,30	60,20		
Q8 RBOYC Guarnitura Q8 ros/bocc.ovale Yale <i>Lever handle Q8 on oval rose-cyl escutcheon</i>	55796225501	55796225503	55796225504	55796225507	55796225550	1	-
	28,20	32,30	28,50	32,30	60,20		
CREM/MART SG Cremonese-martellina Q7 senza gioco <i>Window handle Q7 with mechanism</i>	55796400001	55796400003	55796400004	55796400007	55796400050	2	100
	12,30	14,60	12,70	14,60	37,60		
DK x 40-35 Martellina DK Q7 x 40-35 <i>Window handle Q7 DK-tilt & turn handle</i>	55796557001	55796557003	55796557004	55796557007	55796557050	2	100
	15,10	18,50	15,30	18,50	34,20		
DK x 40-35 C/BUSS. Martellina DK Q7 x 40-35 con bussole D. 9,5 <i>Window handle Q7 DK-tilt & turn handle with pins D. 9,5</i>	55796558001	55796558003	55796558004	55796558007	55796558050	2	100
	15,10	18,50	15,30	18,50	34,20		

Tutte le versioni cremonesi e martellina sono realizzabili applicando al CREM/MART SG i giochi disponibili a pag. 245

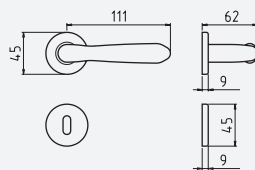
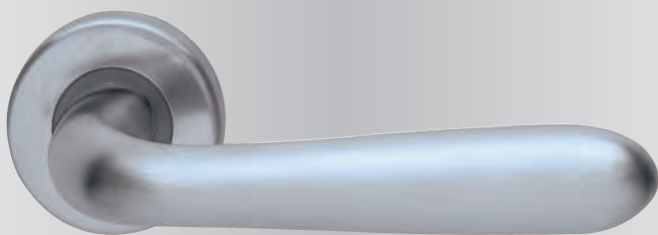

Ros 45x9		
38-43		
A richiesta / On request		
38	30	
50	50	

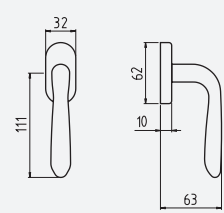

ZCS



GCTOL



ZCL



ZNS

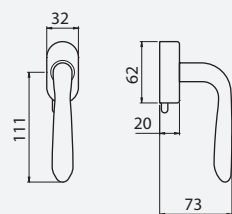

Per maggiori informazioni - For more information:

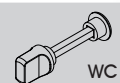

	GCTOL	ZCL	ZCS	ZNS	Conf. pz.	lmb. pz.
Q8 R	66546280012	66546280007	66546280013	66546280027		
Guarnitura Q8 ros. senza boccc.					1	50
<i>Lever handle Q8 on rose</i>	18,30	18,70	18,70	19,20		
Q8 RB	66546281012	66546281007	66546281013	66546281027		
Guarnitura Q8 ros./bocc. patent					1	50
<i>Lever handle Q8 on rose-key escutcheon</i>	21,40	22,70	22,70	23,15		
Q8 RBY	66546285012	66546285007	66546285013	66546285027		
Guarnitura Q8 ros./bocc. Yale					1	50
<i>Lever handle Q8 on rose-cyl escutcheon</i>	21,40	22,70	22,70	23,15		
Q8 RBWC	66546288012	66546288007	66546288013	66546288027		
Guarnitura Q8 ros./bocc.Wc					1	50
<i>Lever handle Q8 on rose-WC function</i>	27,60	30,20	30,20	30,60		

DK x 40-35	66546557012	66546557007	66546557013	66546557027		
Martellina DK Q7 x 40-35					2	100
<i>Window handle Q7 DK-tilt & turn handle</i>	10,40	11,10	11,10	11,50		
DK x 40-35 C/BUSS.	66546558012	66546558007	66546558013	66546558027		
Martellina DK Q7 x 40-35 con bussole D. 9,5					2	100
<i>Window handle Q7 DK-tilt & turn handle with pins D. 9,5</i>	10,40	11,10	11,10	11,50		

DK x 40-35 CON PERNO SIC	66546562012	66546562007	66546562013	66546562027		
Martellina DK Q7 x 40-35					2	100
<i>Window handle Q7 DK-tilt & turn handle</i>	28,20	31,10	31,10	31,60		
DK x 40-35 C/BUSS CON PERNO SIC	66546563012	66546563007	66546563013	66546563027		
Martellina DK Q7 x 40-35 con bussole D. 9,5					2	100
<i>Window handle Q7 DK-tilt & turn handle with pins D. 9,5</i>	28,20	31,10	31,10	31,60		
DK x 40-35 C/BUSS CON PERNO SIC	66546564012	66546564007	66546564013	66546564027		
Martellina DK Q7 x 40-35 con bussole D.11,5					2	100
<i>Window handle Q7 DK-tilt & turn handle with pins D. 9,5</i>	28,20	31,10	31,10	31,60		



GCTOL



F1-SAT

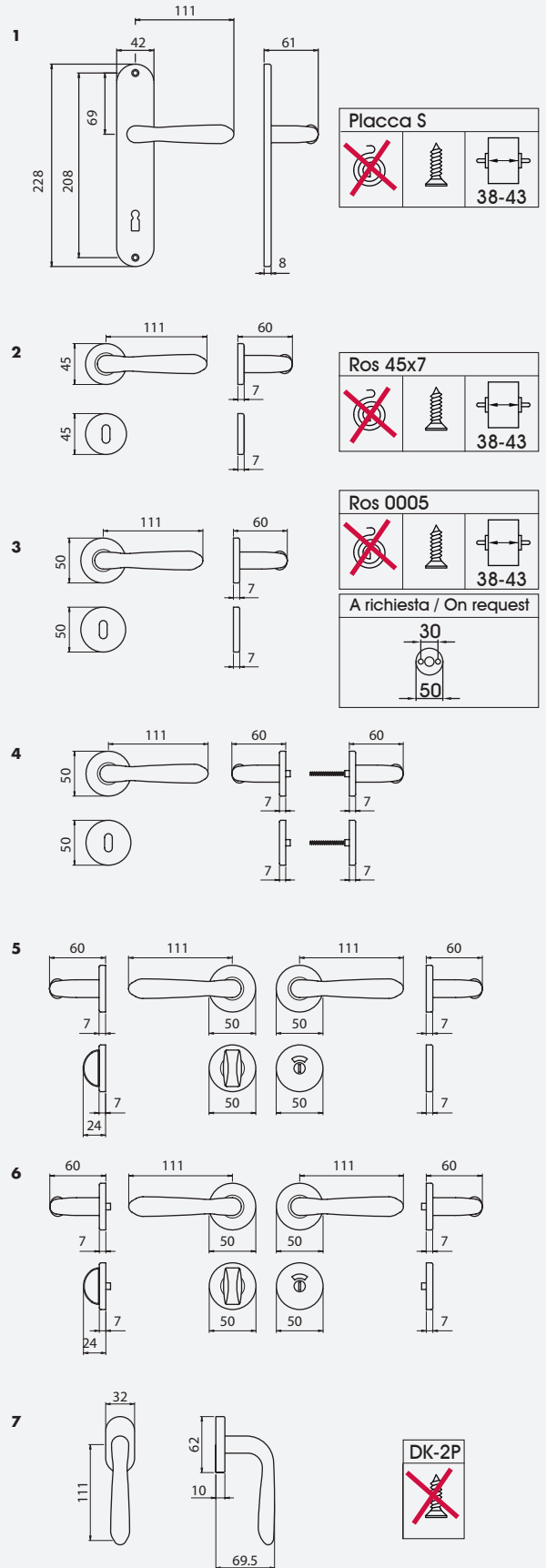

Per maggiori informazioni - For more information:

		GCTOL	F1-SAT	€	Conf. pz.
1	Q8 P90	77796089012	77796089033	18,30	10
		7779608901250	7779608903350	18,10	50
	Q8 P70	77796087012	77796087033	18,30	10
		7779608701250	7779608703350	18,10	50
	Q8 PY85	77796088512	77796088533	18,30	10
		7779608851250	7779608853350	18,10	50
2	Q8 R 45	77796280012	77796280033	14,10	10
		7779628001250	7779628003350	13,90	50
	Q8 RB 45	77796281012	77796281033	16,20	10
		7779628101250	7779628103350	16,00	50
	Q8 RBY 45	77796285012	77796285033	16,20	10
		7779628501250	7779628503350	16,00	50
3	Q8 R 50	77796230012	77796230033	14,40	10
		7779623001250	7779623003350	14,20	50
	Q8 RB 50	77796231012	77796231033	16,60	10
		7779623101250	7779623103350	16,40	50
	Q8 RBB 50	77796231712	77796231733	16,60	10
		7779623171250	7779623173350	16,40	50
Q8 RBY 50	77796235012	77796235033	16,60	10	
	7779623501250	7779623503350	16,40	50	
4	Q8 R 50 C/B	77796250512	77796250533	14,40	10
		7779625051250	7779625053350	14,20	50
	Q8 RB 50 C/B	77796251512	77796251533	16,60	10
		7779625151250	7779625153350	16,40	50
	Q8 RBB 50 C/B	77796251712	77796251733	16,60	10
		7779625171250	7779625173350	16,40	50
Q8 RBY 50 C/B	77796255512	77796255533	16,60	10	
	7779625551250	7779625553350	16,40	50	
5	Q8 RBWC Q6 50	77796238012	77796238033	20,20	10
		7779623801250	7779623803350	20,00	50
	Q8 RBWC Q8 50	77796238812	77796238833	20,20	10
		7779623881250	7779623883350	20,00	50
6	Q8 RBWC Q6 50 C/B	77796258012	77796258033	21,10	10
		7779625801250	7779625803350	20,90	50
	Q8 RBWC Q8 50 C/B	77796258812	77796258833	21,10	10
		7779625881250	7779625883350	20,90	50
7	DK x 40-35	77796557012	77796557033	9,60	20
		7779655701250	7779655703350	9,40	100
	DK x 40-35 C/BUSS. D.9,5	77796558012	77796558033	9,60	20
		7779655801250	7779655803350	9,40	100

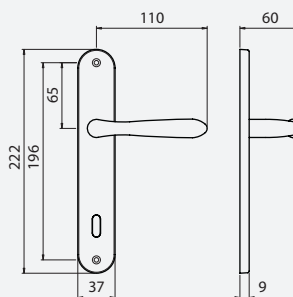

Placca EVA		
		38-43

GCTOL

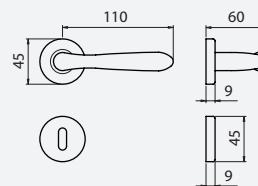

Ros 45x9		
		38-43

A richiesta / On request	
38	30
50	50



ZCS



OGV-M27



ZCL



OS-M2

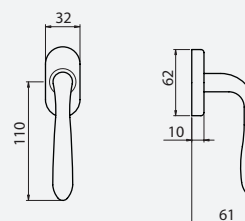

Per maggiori informazioni - For more information:

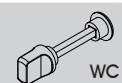

GM05 GM05-Z

	OGV M27	OS M2	Conf. pz.
Q8 P90 Guarnitura Q8 placca patent 90 <i>Lever handle Q8 on key plate 90</i>	5GM88089004	5GM88089008	25
	23,80	23,80	
Q8 P70 Guarnitura Q8 placca patent 70 <i>Lever handle Q8 on key plate 70</i>	5GM88087004	5GM88087008	25
	23,80	23,80	
Q8 PY85 Guarnitura Q8 placca yale 85 <i>Lever handle Q8 on cyl. plate 85</i>	5GM88088504	5GM88088508	25
	23,80	23,80	

	GCTOL	ZCL	ZCS	OGV M27	OS M2	Conf. pz.
Q8 R Guarnitura Q8 ros. senza bocc. <i>Lever handle Q8 on rose</i>	6GM58280012	6GM58280007	6GM58280013	5GM88280004	5GM88280008	25
	13,10	14,20	14,20	15,10	15,10	
Q8 RB Guarnitura Q8 ros./bocc. patent <i>Lever handle Q8 on rose-key escutcheon</i>	6GM58281012	6GM58281007	6GM58281013	5GM88281004	5GM88281008	25
	15,80	16,80	16,80	18,30	18,30	
Q8 RBY Guarnitura Q8 ros./bocc. Yale <i>Lever handle Q8 on rose-cyl escutcheon</i>	6GM58285012	6GM58285007	6GM58285013	5GM88285004	5GM88285008	25
	15,80	16,80	16,80	18,30	18,30	
Q8 RBWC Guarnitura Q8 ros./bocc.Wc <i>Lever handle Q8 on rose-WC function</i>	6GM58288012	6GM58288007	6GM58288013	5GM88288004	5GM88288008	25
	21,00	23,10	23,10	26,50	26,50	

DK x 40-35 Martellina DK Q7 x 40-35 <i>Window handle Q7 DK-tilt & turn handle</i>	6GM58557012	6GM58557007	6GM58557013	5GM88557004	5GM88557008	50
	7,90	10,50	10,50	11,70	11,70	
DK x 40-35 C/BUSS. Martellina DK Q7 x 40-35 con bussole D. 9,5 <i>Window handle Q7 DK-tilt & turn handle with pins d.9,5</i>	6GM58558012	6GM58558007	6GM58558013	5GM88558004	5GM88558008	50
	7,90	10,50	10,50	11,70	11,70	



OLV-M1

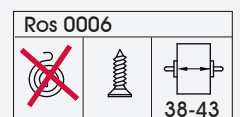
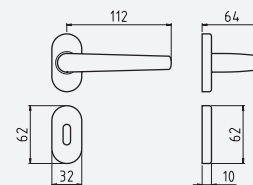
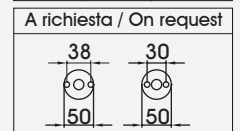
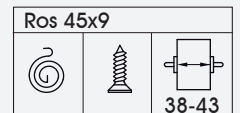
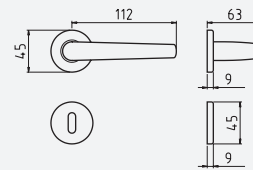
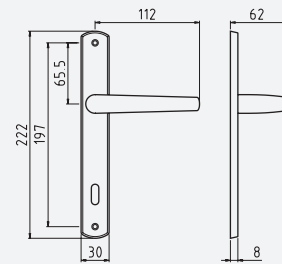
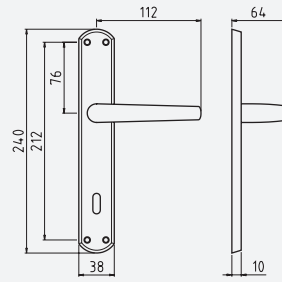

OCS-M18



OGV-M27



OCL-M4



OS-M2

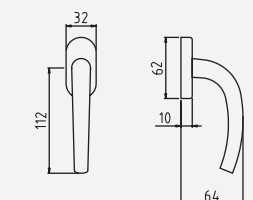
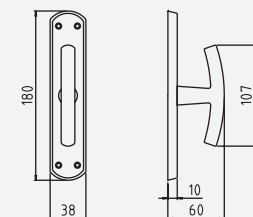

Per maggiori informazioni - For more information:

Rosette da pag. 246 a pag. 257
 Placche da pag. 265 a pag. 267
 DK da pag. 262 a pag. 264

Roses from pag. 246 to pag. 257
 Plates from pag. 265 to pag. 267
 Window handles from pag. 262 to pag. 264

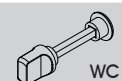

	OLV M1	OCS M18	OGV M27	OCL M4	OS M2	Conf. pz.	Imb. pz.
Q8 P90 Guarnitura Q8 placca patent 90 <i>Lever handle Q8 on key plate 90</i>	55744089001	55744089003	55744089004	55744089007	55744089008	1	20
	22,20	29,10	22,20	29,10	22,20		
Q8 P70 Guarnitura Q8 placca patent 70 <i>Lever handle Q8 on key plate 70</i>	55744087001	55744087003	55744087004	55744087007	55744087008	1	20
	22,20	29,10	22,20	29,10	22,20		
Q8 PY85 Guarnitura Q8 placca yale 85 <i>Lever handle Q8 on cyl. plate 85</i>	55744088501	55744088503	55744088504	55744088507	55744088508	1	20
	22,20	29,10	22,20	29,10	22,20		
Q8 P90RS Guarnitura Q8 placca stretta pat 90 <i>Lever handle Q8 on reduced key plate 90</i>	55744051001	55744051003	55744051004	55744051007	55744051008	1	-
	24,50	32,00	24,50	32,00	24,50		
Q8 P70RS Guarnitura Q8 placca stretta pat 70 <i>Lever handle Q8 on reduced key plate 70</i>	55744057001	55744057003	55744057004	55744057007	55744057008	1	-
	24,50	32,00	24,50	32,00	24,50		
Q8 PY85RS Guarnitura Q8 placca stretta yale 85 <i>Lever handle Q8 on reduced cyl. plate 85</i>	55744055001	55744055003	55744055004	55744055007	55744055008	1	-
	24,50	32,00	24,50	32,00	24,50		
Q8 R Guarnitura Q8 ros. senza bocc. <i>Lever handle Q8 on rose</i>	55744280501	55744280503	55744280504	55744280507	55744280508	1	50
	16,40	21,90	16,40	21,90	16,40		
Q8 RB Guarnitura Q8 ros./bocc. patent <i>Lever handle Q8 on rose-key escutcheon</i>	55744281501	55744281503	55744281504	55744281507	55744281508	1	50
	20,50	27,40	20,50	27,40	20,50		
Q8 RBY Guarnitura Q8 ros./bocc. Yale <i>Lever handle Q8 on rose-cyl escutcheon</i>	55744285501	55744285503	55744285504	55744285507	55744285508	1	50
	20,50	27,40	20,50	27,40	20,50		
Q8 RBWC Guarnitura Q8 ros./bocc.Wc <i>Lever handle Q8 on rose-WC function</i>	55744288001	55744288003	55744288004	55744288007	55744288008	1	50
	27,40	36,90	27,40	36,90	27,40		
Q8 ROC Guarnitura Q8 ros.ovale senza bocc. <i>Lever handle Q8 on oval rose</i>	55744220501	55744220503	55744220504	55744220507	55744220508	1	-
	18,10	24,10	18,10	24,10	18,10		
Q8 RBOC Guarnitura Q8 ros/bocc.ovale patent <i>Lever handle Q8 on oval rose-key escutcheon</i>	55744221501	55744221503	55744221504	55744221507	55744221508	1	-
	22,60	30,10	22,60	30,10	22,60		
Q8 RBOYC Guarnitura Q8 ros/bocc.ovale Yale <i>Lever handle Q8 on oval rose-cyl escutcheon</i>	55744225501	55744225503	55744225504	55744225507	55744225508	1	-
	22,60	30,10	22,60	30,10	22,60		
EZ Cremonese gioco EZ <i>Window handle Q7 with mechanism</i>	55744406001	55744406003	55744406004	55744406007	55744406008	2	100
	13,70	17,10	13,70	17,10	13,70		
EZQ7 Cremonese gioco EZ + Q7 <i>Window handle Q7 with mechanism</i>	55744407001	55744407003	55744407004	55744407007	55744407008	2	100
	14,10	17,50	14,10	17,50	14,10		
MART Martellina Q7 <i>Window handle Q7</i>	55744500001	55744500003	55744500004	55744500007	55744500008	2	100
	13,00	17,10	13,00	17,10	13,00		
DK x 40-35 Martellina DK Q7 x 40-35 <i>Window handle Q7 DK-tilt & turn handle</i>	55744577001	55744577003	55744577004	55744577007	55744577008	2	100
	10,50	13,70	10,50	13,70	10,50		
DK x 40-35 C/BUSS. Martellina DK Q7 x 40-35 con bussole D. 9,5 <i>Window handle Q7 DK-tilt & turn handle with pins D. 9,5</i>	55744578001	55744578003	55744578004	55744578007	55744578008	2	100
	10,50	13,70	10,50	13,70	10,50		



ONS-M9



G-PLUS-M36

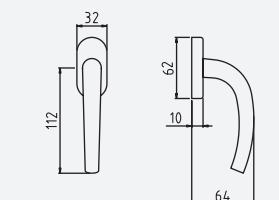
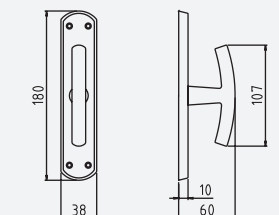
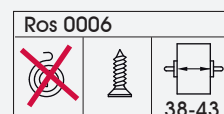
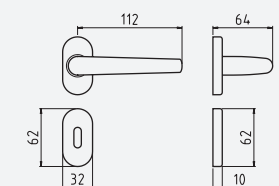
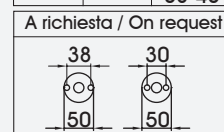
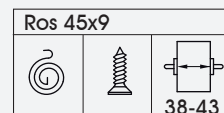
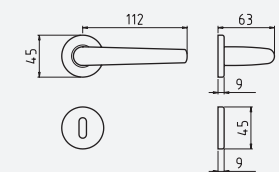
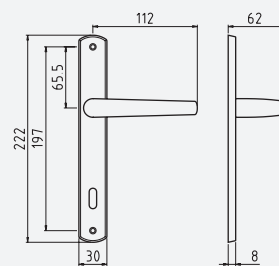
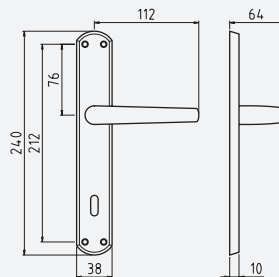

Per maggiori informazioni - For more information:

Rosette da pag. 246 a pag. 257
 Placche da pag. 265 a pag. 267
 DK da pag. 262 a pag. 264

Roses from pag. 246 to pag. 257
 Plates from pag. 265 to pag. 267
 Window handles from pag. 262 to pag. 264

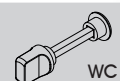

	ONS M9	G-PLUS M36	Conf. pz.
Q8 P90 Guarnitura Q8 placca patent 90 <i>Lever handle Q8 on key plate 90</i>	55744089027 36,90	55744089050 61,50	1
Q8 P70 Guarnitura Q8 placca patent 70 <i>Lever handle Q8 on key plate 70</i>	55744087027 36,90	55744087050 61,50	1
Q8 PY85 Guarnitura Q8 placca yale 85 <i>Lever handle Q8 on cyl. plate 85</i>	55744088527 36,90	55744088550 61,50	1
Q8 P90RS Guarnitura Q8 placca stretta pat 90 <i>Lever handle Q8 on reduced key plate 90</i>	55744051027 40,60	55744051050 67,70	1
Q8 P70RS Guarnitura Q8 placca stretta pat 70 <i>Lever handle Q8 on reduced key plate 70</i>	55744057027 40,60	55744057050 67,70	1
Q8 PY85RS Guarnitura Q8 placca stretta yale 85 <i>Lever handle Q8 on reduced cyl. plate 85</i>	55744055027 40,60	55744055050 67,70	1
Q8 R Guarnitura Q8 ros. senza bocc. <i>Lever handle Q8 on rose</i>	55744280527 28,40	55744280550 42,70	1
Q8 RB Guarnitura Q8 ros./bocc. patent <i>Lever handle Q8 on rose-key escutcheon</i>	55744281527 35,20	55744281550 54,70	1
Q8 RBY Guarnitura Q8 ros./bocc. Yale <i>Lever handle Q8 on rose-cyl escutcheon</i>	55744285527 35,20	55744285550 54,70	1
Q8 RBWC Guarnitura Q8 ros./bocc.Wc <i>Lever handle Q8 on rose-WC function</i>	55744288027 45,50	55744288050 65,30	1
Q8 ROC Guarnitura Q8 ros.ovale senza bocc. <i>Lever handle Q8 on oval rose</i>	55744220527 31,20	55744220550 47,00	1
Q8 RBOC Guarnitura Q8 ros/bocc.ovale patent <i>Lever handle Q8 on oval rose-key escutcheon</i>	55744221527 38,70	55744221550 60,20	1
Q8 RBOYC Guarnitura Q8 ros/bocc.ovale Yale <i>Lever handle Q8 on oval rose-cyl escutcheon</i>	55744225527 38,70	55744225550 60,20	1
EZ Cremonese gioco EZ <i>Window handle Q7 with mechanism</i>	55744406027 21,90	55744406050 41,50	2
EZQ7 Cremonese gioco EZ + Q7 <i>Window handle Q7 with mechanism</i>	55744407027 22,30	55744407050 41,90	2
MART Martellina Q7 <i>Window handle Q7</i>	55744500027 21,20	55744500050 41,50	2
DK x 40-35 Martellina DK Q7 x 40-35 <i>Window handle Q7 DK-tilt & turn handle</i>	55744577027 21,90	55744577050 34,20	2
DK x 40-35 C/BUSS. Martellina DK Q7 x 40-35 con bussole D. 9,5 <i>Window handle Q7 DK-tilt & turn handle with pins D. 9,5</i>	55744578027 21,90	55744578050 34,20	2

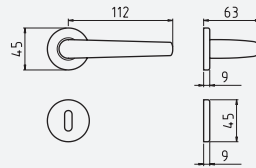

Ros 45x9		
38-43		
A richiesta / On request		
38	30	
50	50	

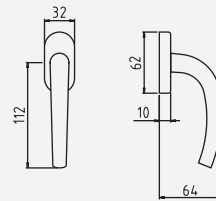

GCTOL



ZCL



ZCS

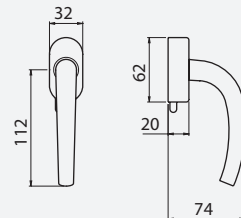

Per maggiori informazioni - For more information:

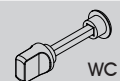

	GCTOL	ZCL	ZCS	Conf. pz.	Imb. pz.
Q8 R	66744280512	66744280507	66744280513		
Guarnitura Q8 ros. senza bocc.				1	50
<i>Lever handle Q8 on rose</i>	17,20	17,60	17,60		
Q8 RB	66744281512	66744281507	66744281513		
Guarnitura Q8 ros./bocc. patent				1	50
<i>Lever handle Q8 on rose-key escutcheon</i>	20,40	21,60	21,60		
Q8 RBY	66744285512	66744285507	66744285513		
Guarnitura Q8 ros./bocc. Yale				1	50
<i>Lever handle Q8 on rose-cyl escutcheon</i>	20,40	21,60	21,60		
Q8 RBWC	66744288012	66744288007	66744288013		
Guarnitura Q8 ros./bocc.Wc				1	50
<i>Lever handle Q8 on rose-WC function</i>	26,60	29,20	29,20		

DK x 40-35	66744557012	66744557007	66744557013		
Martellina DK Q7 x 40-35				2	100
<i>Window handle Q7 DK-tilt & turn handle</i>	9,90	10,60	10,60		
DK x 40-35 C/BUSS.	66744558012	66744558007	66744558013		
Martellina DK Q7 x 40-35 con bussole D. 9,5				2	100
<i>Window handle Q7 DK-tilt & turn handle with pins D. 9,5</i>	9,90	10,60	10,60		

DK x 40-35 CON PERNO SIC	66744562012	66744562007	66744562013		
Martellina DK Q7 x 40-35				2	100
<i>Window handle Q7 DK-tilt & turn handle</i>	27,80	31,10	31,10		
DK x 40-35 C/BUSS CON PERNO SIC	66744563012	66744563007	66744563013		
Martellina DK Q7 x 40-35 con bussole D. 9,5				2	100
<i>Window handle Q7 DK-tilt & turn handle with pins D. 9,5</i>	27,80	31,10	31,10		
DK x 40-35 C/BUSS CON PERNO SIC	66744564012	66744564007	66744564013		
Martellina DK Q7 x 40-35 con bussole D.11,5				2	100
<i>Window handle Q7 DK-tilt & turn handle with pins D. 9,5</i>	27,80	31,10	31,10		



GCTOL



F1-SAT

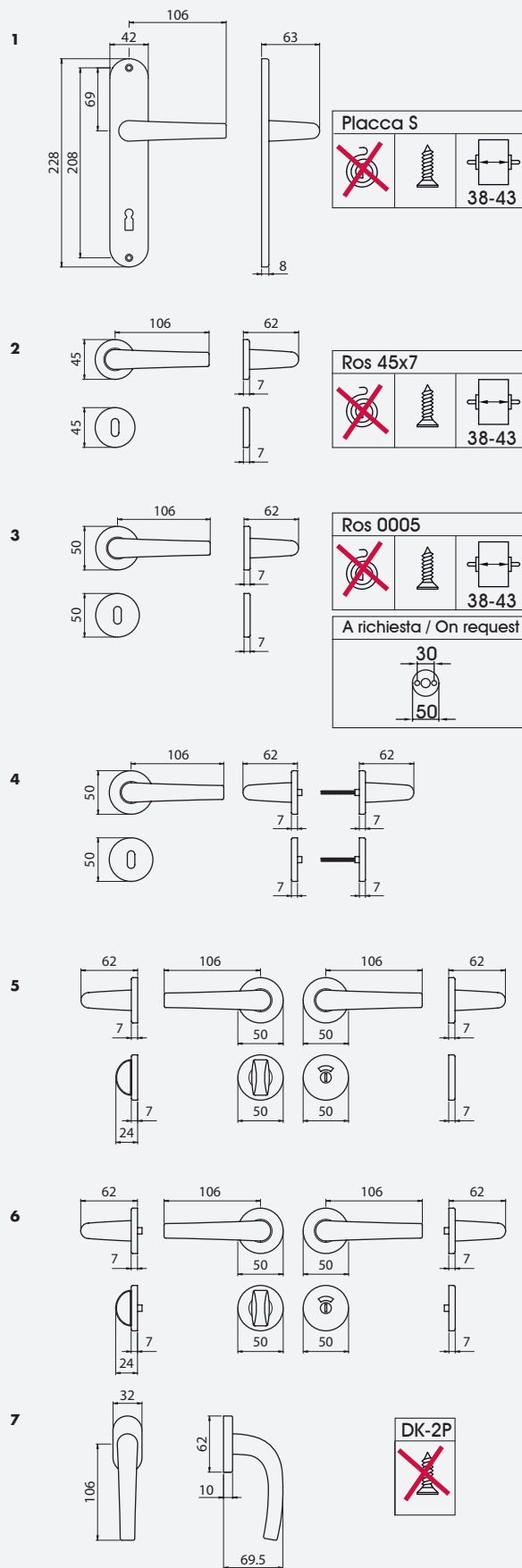

Per maggiori informazioni - For more information:

		GCTOL	F1-SAT	€	Conf. pz.
1	Q8 P90	72040089012	72040089033	17,50	10
		7204008901250	7204008903350	17,30	50
	Q8 P70	72040087012	72040087033	17,50	10
		7204008701250	7204008703350	17,30	50
	Q8 PY85	72040088512	72040088533	17,50	10
		7204008851250	7204008853350	17,30	50
2	Q8 R 45	72040280012	72040280033	13,30	10
		7204028001250	7204028003350	13,10	50
	Q8 RB 45	72040281012	72040281033	15,40	10
		7204028101250	7204028103350	15,20	50
	Q8 RBY 45	72040285012	72040285033	15,40	10
		7204028501250	7204028503350	15,20	50
3	Q8 R 50	72040230012	72040230033	13,60	10
		7204023001250	7204023003350	13,40	50
	Q8 RB 50	72040231012	72040231033	15,90	10
		7204023101250	7204023103350	15,60	50
	Q8 RBB 50	72040231712	72040231733	15,90	10
		7204023171250	7204023173350	15,60	50
Q8 RBY 50	72040235012	72040235033	15,90	10	
	7204023501250	7204023503350	15,60	50	
4	Q8 R 50 C/B	72040250512	72040250533	13,60	10
		7204025051250	7204025053350	13,40	50
	Q8 RB 50 C/B	72040251512	72040251533	15,90	10
		7204025151250	7204025153350	15,60	50
	Q8 RBB 50 C/B	72040251712	72040251733	15,90	10
		7204025171250	7204025173350	15,60	50
Q8 RBY 50 C/B	72040255512	72040255533	15,90	10	
	7204025551250	7204025553350	15,60	50	
5	Q8 RBWC Q6 50	72040238012	72040238033	19,40	10
		7204023801250	7204023803350	19,20	50
	Q8 RBWC Q8 50	72040238812	72040238833	19,40	10
		7204023881250	7204023883350	19,20	50
6	Q8 RBWC Q6 50 C/B	72040258012	72040258033	20,30	10
		7204025801250	7204025803350	20,10	50
	Q8 RBWC Q8 50 C/B	72040258812	72040258833	20,30	10
		7204025881250	7204025883350	20,10	50
7	DK x 40-35	72040557012	72040557033	9,30	20
		7204055701250	7204055703350	9,10	100
	DK x 40-35 C/BUSS. D.9,5	72040558012	72040558033	9,30	20
		7204055801250	7204055803350	9,10	100

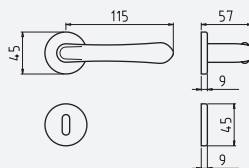
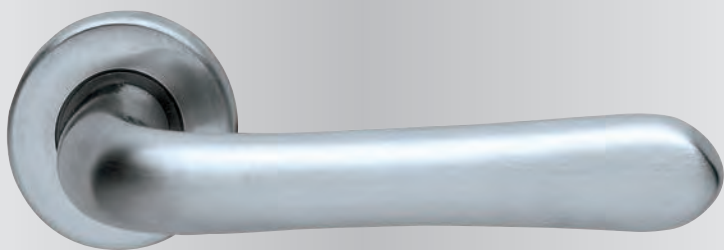

Ros 45x9		
		38-43
A richiesta / On request		
38	30	
50	50	

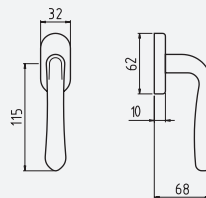

ZCS



GCTOL



Per maggiori informazioni - For more information:

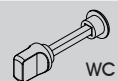

	GCTOL	ZCS	Conf. pz.	lmb. pz.
Q8 R	66032280012	66032280013	1	50
Guarnitura Q8 ros. senza bocc.	17,10	17,90		
<i>Lever handle Q8 on rose</i>				
Q8 RB	66032281012	66032281013	1	50
Guarnitura Q8 ros./bocc. patent	19,80	20,20		
<i>Lever handle Q8 on rose-key escutcheon</i>				
Q8 RB Y	66032285012	66032285013	1	50
Guarnitura Q8 ros./bocc. Yale	19,80	20,20		
<i>Lever handle Q8 on rose-cyl escutcheon</i>				
Q8 RBWC	66032288012	66032288013	1	50
Guarnitura Q8 ros./bocc.Wc	25,90	26,90		
<i>Lever handle Q8 on rose-WC function</i>				
DK x 40	66032557012	66032557013	2	100
Martellina DK Q7 x 40	10,10	10,50		
<i>Window handle Q7 DK-tilt & turn handle</i>				
DK x 40 C/BUSS.	66032558012	66032558013	2	100
Martellina DK Q7 x 40 con bussole D. 9,5	10,10	10,50		
<i>Window handle Q7 DK-tilt & turn handle with pins D. 9,5</i>				



GCTOL



F1-SAT

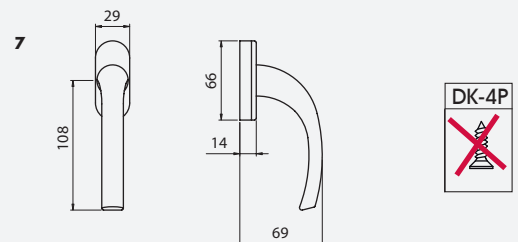
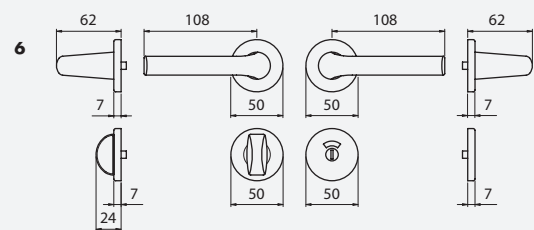
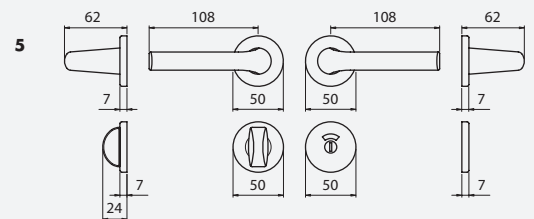
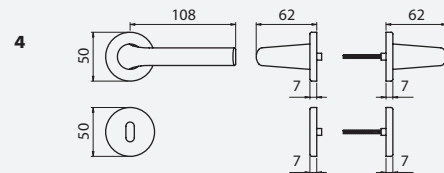
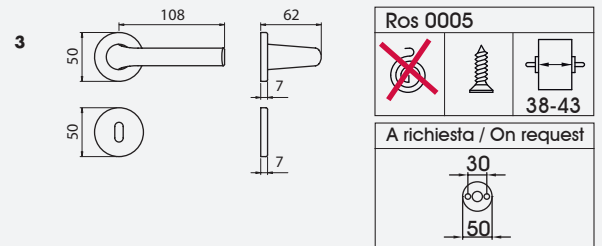
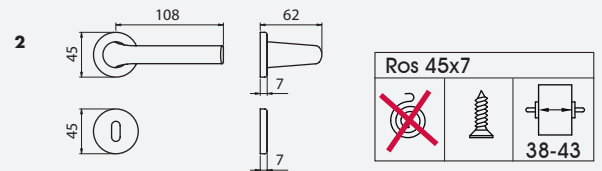
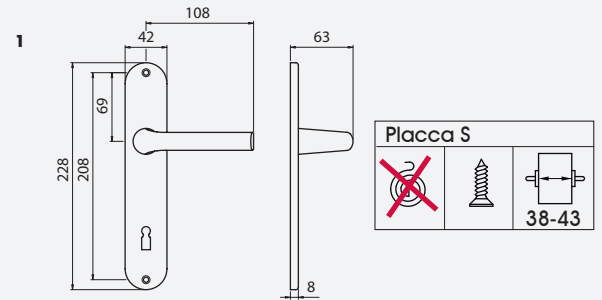

Per maggiori informazioni - For more information:

		GCTOL	F1-SAT	€	Conf. pz.
1	Q8 P90	77438089012	77438089033	17,80	10
		7743808901250	7743808903350	17,60	50
	Q8 P70	77438087012	77438087033	17,80	10
		7743808701250	7743808703350	17,60	50
	Q8 PY85	77438088512	77438088533	17,80	10
		7743808851250	7743808853350	17,60	50
2	Q8 R 45	77438280012	77438280033	13,70	10
		7743828001250	7743828003350	13,40	50
	Q8 RB 45	77438281012	77438281033	15,80	10
		7743828101250	7743828103350	15,60	50
	Q8 RBY 45	77438285012	77438285033	15,80	10
		7743828501250	7743828503350	15,60	50
3	Q8 R 50	77438230012	77438230033	13,90	10
		7743823001250	7743823003350	13,70	50
	Q8 RB 50	77438231012	77438231033	16,20	10
		7743823101250	7743823103350	16,00	50
	Q8 RBB 50	77438231712	77438231733	16,20	10
		7743823171250	7743823173350	16,00	50
Q8 RBY 50	77438235012	77438235033	16,20	10	
	7743823501250	7743823503350	16,00	50	
4	Q8 R 50 C/B	77438250512	77438250533	13,90	10
		7743825051250	7743825053350	13,70	50
	Q8 RB 50 C/B	77438251512	77438251533	16,20	10
		7743825151250	7743825153350	16,00	50
	Q8 RBB 50 C/B	77438251712	77438251733	16,20	10
		7743825171250	7743825173350	16,00	50
Q8 RBY 50 C/B	77438255512	77438255533	16,20	10	
	7743825551250	7743825553350	16,00	50	
5	Q8 RBWC Q6 50	77438238012	77438238033	19,70	10
		7743823801250	7743823803350	19,50	50
	Q8 RBWC Q8 50	77438238812	77438238833	19,70	10
		7743823881250	7743823883350	19,50	50
6	Q8 RBWC Q6 50 C/B	77438258012	77438258033	20,70	10
		7743825801250	7743825803350	20,50	50
	Q8 RBWC Q8 50 C/B	77438258812	77438258833	20,70	10
		7743825881250	7743825883350	20,50	50
7	DK x 40	77438557012	77438557033	7,40	20
		7743855701250	7743855703350	7,10	100
	DK x 40 C/BUSS. D.9,5	77438558012	77438558033	7,40	20
		7743855801250	7743855803350	7,10	100



GCTOL



F1-SAT

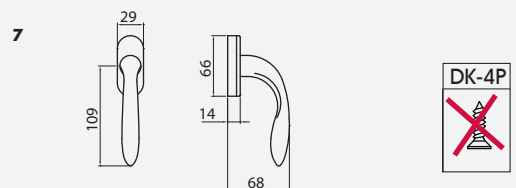
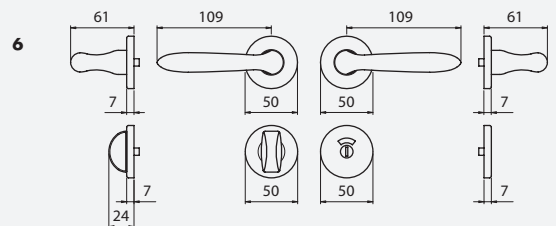
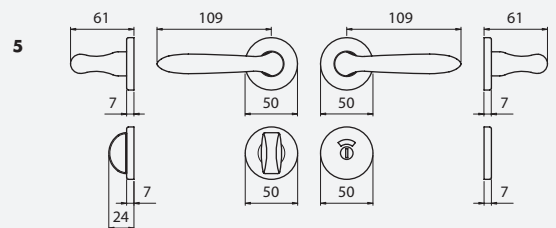
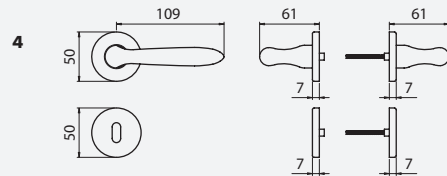
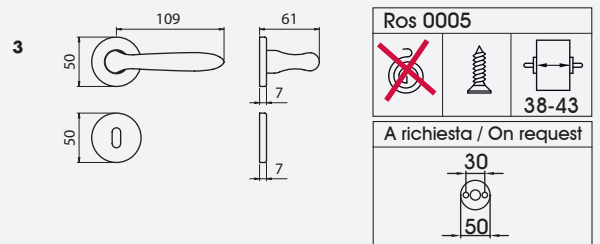
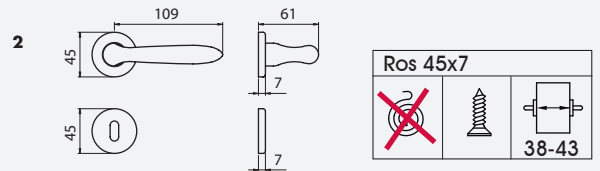
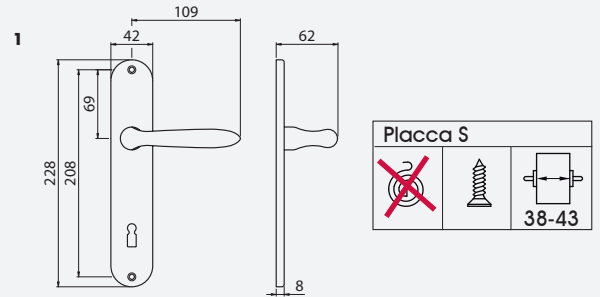

Per maggiori informazioni - For more information:

		GCTOL	F1-SAT	€	Conf. pz.
1	Q8 P90	77436089012	77436089033	18,00	10
		7743608901250	7743608903350	17,80	50
	Q8 P70	77436087012	77436087033	18,00	10
		7743608701250	7743608703350	17,80	50
	Q8 PY85	77436088512	77436088533	18,00	10
		7743608851250	7743608853350	17,80	50
2	Q8 R 45	77436280012	77436280033	13,90	10
		7743628001250	7743628003350	13,70	50
	Q8 RB 45	77436281012	77436281033	16,00	10
		7743628101250	7743628103350	15,80	50
	Q8 RBY 45	77436285012	77436285033	16,00	10
		7743628501250	7743628503350	15,80	50
3	Q8 R 50	77436230012	77436230033	14,10	10
		7743623001250	7743623003350	13,90	50
	Q8 RB 50	77436231012	77436231033	16,40	10
		7743623101250	7743623103350	16,20	50
	Q8 RBB 50	77436231712	77436231733	16,40	10
		7743623171250	7743623173350	16,20	50
Q8 RBY 50	77436235012	77436235033	16,40	10	
	7743623501250	7743623503350	16,20	50	
4	Q8 R 50 C/B	77436250512	77436250533	14,10	10
		7743625051250	7743625053350	13,90	50
	Q8 RB 50 C/B	77436251512	77436251533	16,40	10
		7743625151250	7743625153350	16,20	50
	Q8 RBB 50 C/B	77436251712	77436251733	16,40	10
		7743625171250	7743625173350	16,20	50
Q8 RBY 50 C/B	77436255512	77436255533	16,40	10	
	7743625551250	7743625553350	16,20	50	
5	Q8 RBWC Q6 50	77436238012	77436238033	20,00	10
		7743623801250	7743623803350	19,70	50
	Q8 RBWC Q8 50	77436238812	77436238833	20,00	10
		7743623881250	7743623883350	19,70	50
6	Q8 RBWC Q6 50 C/B	77436258012	77436258033	20,80	10
		7743625801250	7743625803350	20,70	50
	Q8 RBWC Q8 50 C/B	77436258812	77436258833	20,80	10
		7743625881250	7743625883350	20,70	50
7	DK x 40	77436557012	77436557033	7,50	20
		7743655701250	7743655703350	7,30	100
	DK x 40 C/BUSS. D.9,5	77436558012	77436558033	7,50	20
		7743655801250	7743655803350	7,30	100

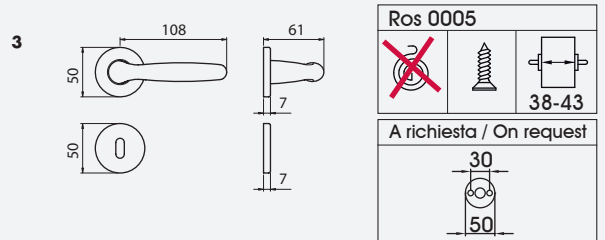
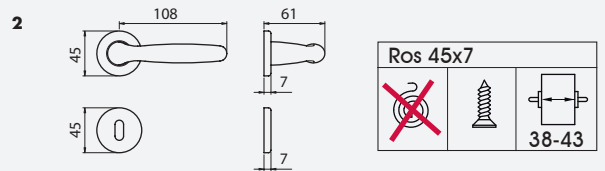
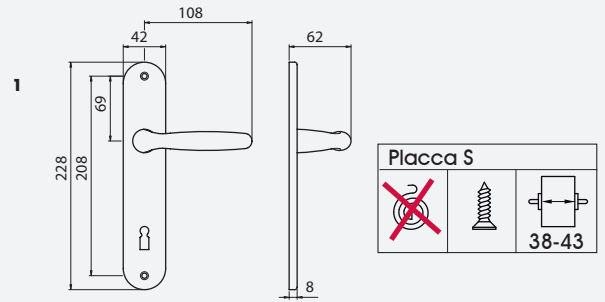

GCTOL



F1-SAT

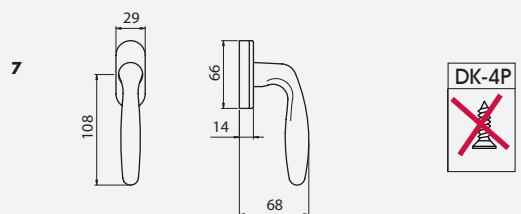
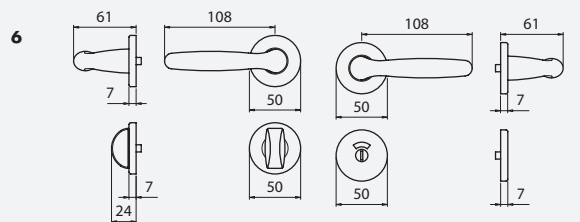
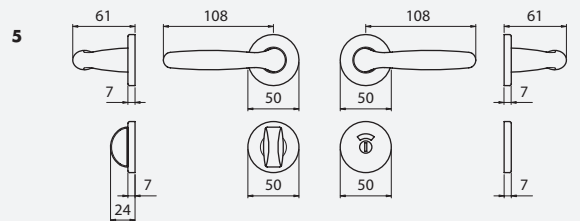
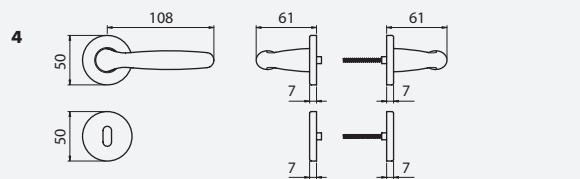

Per maggiori informazioni - For more information:

	GCTOL	F1-SAT	€	Conf. pz.		
1 Q8 P90	72005089012	72005089033	18,00	10		
	7200508901250	7200508903350	17,80	50		
	Q8 P70	72005087012	72005087033	18,00	10	
	7200508701250	7200508703350	17,80	50		
	Q8 PY85	72005088512	72005088533	18,00	10	
	7200508851250	7200508853350	17,80	50		
2 Q8 R 45	72005280012	72005280033	13,90	10		
	7200528001250	7200528003350	13,70	50		
	Q8 RB 45	72005281012	72005281033	16,00	10	
	7200528101250	7200528103350	15,80	50		
	Q8 RBY 45	72005285012	72005285033	16,00	10	
	7200528501250	7200528503350	15,80	50		
3 Q8 R 50	72005230012	72005230033	14,10	10		
	7200523001250	7200523003350	13,90	50		
	Q8 RB 50	72005231012	72005231033	16,40	10	
	7200523101250	7200523103350	16,20	50		
	Q8 RBB 50	72005231712	72005231733	16,40	10	
	7200523171250	7200523173350	16,20	50		
Q8 RBY 50	72005235012	72005235033	16,40	10		
	7200523501250	7200523503350	16,20	50		
	4 Q8 R 50 C/B	72005250512	72005250533	14,10	10	
		7200525051250	7200525053350	13,90	50	
		Q8 RB 50 C/B	72005251512	72005251533	16,40	10
		7200525151250	7200525153350	16,20	50	
Q8 RBB 50 C/B		72005251712	72005251733	16,40	10	
7200525171250		7200525173350	16,20	50		
Q8 RBY 50 C/B	72005255512	72005255533	16,40	10		
	7200525551250	7200525553350	16,20	50		
	5 Q8 RBWC Q6 50	72005238012	72005238033	20,00	10	
		7200523801250	7200523803350	19,70	50	
	Q8 RBWC Q8 50	72005238812	72005238833	20,00	10	
		7200523881250	7200523883350	19,70	50	
6 Q8 RBWC Q6 50 C/B	72005258012	72005258033	20,80	10		
	7200525801250	7200525803350	20,70	50		
	Q8 RBWC Q8 50 C/B	72005258812	72005258833	20,80	10	
	7200525881250	7200525883350	20,70	50		
7 DK x 40	72005557012	72005557033	7,50	20		
	7200555701250	7200555703350	7,30	100		
	DK x 40 C/BUSS. D.9,5	72005558012	72005558033	7,50	20	
	7200555801250	7200555803350	7,30	100		

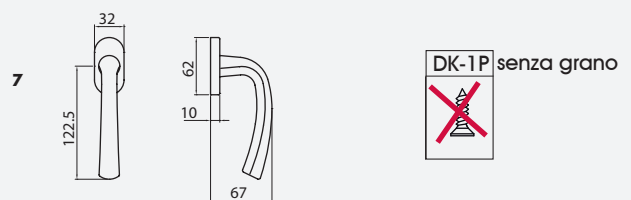
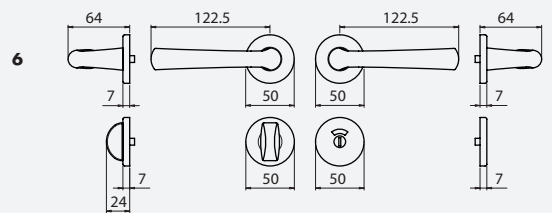
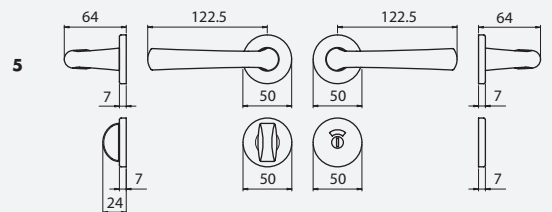
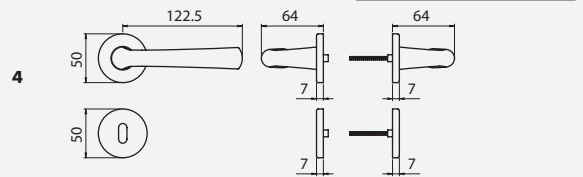
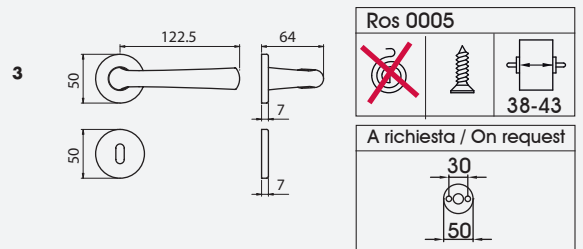
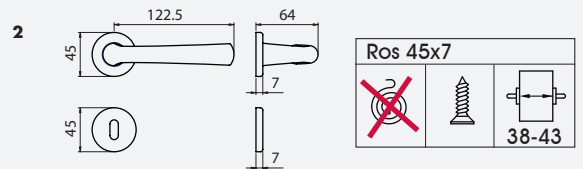
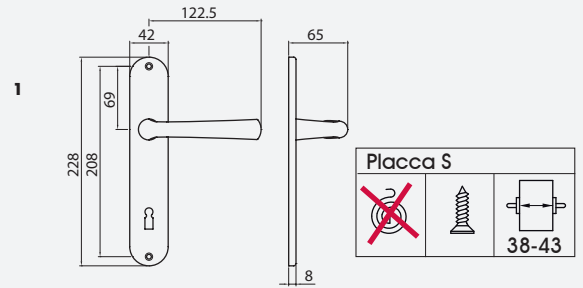

GCTOL



F1-SAT



Per maggiori informazioni - For more information:

	GCTOL	F1-SAT	€	Conf. pz.	
1	Q8 P90	71050089012	71050089033	17,10	10
		7105008901250	7105008903350	16,90	50
	Q8 P70	71050087012	71050087033	17,10	10
		7105008701250	7105008703350	16,90	50
	Q8 PY85	71050088512	71050088533	17,10	10
		7779608851250	7105008853350	16,90	50
2	Q8 R 45	71050280012	71050280033	11,90	10
		7105028001250	7105028003350	11,70	50
	Q8 RB 45	71050281012	71050281033	14,10	10
		7105028101250	7105028103350	13,90	50
	Q8 RBY 45	71050285012	71050285033	14,10	10
		7105028501250	7105028503350	13,90	50
3	Q8 R 50	71050230012	71050230033	12,30	10
		7105023001250	7105023003350	12,10	50
	Q8 RB 50	71050231012	71050231033	15,10	10
		7105023101250	7105023103350	14,90	50
	Q8 RBB 50	71050231712	71050231733	15,10	10
		7105023171250	7105023173350	14,90	50
Q8 RBY 50	71050235012	71050235033	15,10	10	
	7105023501250	7105023503350	14,90	50	
4	Q8 R 50 C/B	71050250512	71050250533	12,30	10
		7105025051250	7105025053350	12,10	50
	Q8 RB 50 C/B	71050251512	71050251533	15,10	10
		7105025151250	7105025153350	14,90	50
	Q8 RBB 50 C/B	71050251712	71050251733	15,10	10
		7105025171250	7105025173350	14,90	50
Q8 RBY 50 C/B	71050255512	71050255533	15,10	10	
	7105025551250	7105025553350	14,90	50	
5	Q8 RBWC Q6 50	71050238012	71050238033	18,30	10
		7105023801250	7105023803350	18,10	50
	Q8 RBWC Q8 50	71050238812	71050238833	18,30	10
		7105023881250	7105023883350	18,10	50
6	Q8 RBWC Q6 50 C/B	71050258012	71050258033	18,50	10
		7105025801250	7105025803350	18,30	50
	Q8 RBWC Q8 50 C/B	71050258812	71050258833	18,50	10
		7105025881250	7105025883350	18,30	50
7	DK x 40	71050557012	71050557033	7,45	20
		7105055701250	7105055703350	7,25	100
	DK x 40 C/BUSS. D.9,5	71050558012	71050558033	7,45	20
		7105055801250	7105055803350	7,25	100



OLV-M1

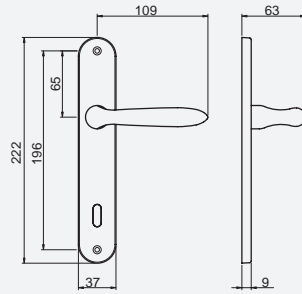

Placca EVA		
38-43		

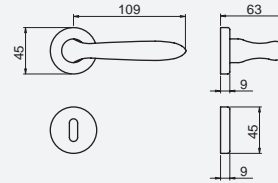

Ros 45x9		
38-43		

A richiesta / On request	
38	30
50	50



OCS-M18



OGV-M27



OCL-M4



OS-M2

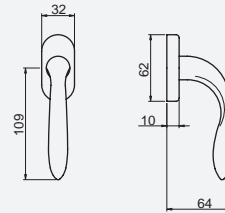

Per maggiori informazioni - For more information:

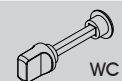

	OLV M1	OCS M18	OGV M27	OCL M4	OS M2	Conf. pz.
Q8 P90 Guarnitura Q8 placca patent 90 <i>Lever handle Q8 on key plate 90</i>	5GM92089001	5GM92089003	5GM92089004	5GM92089007	5GM92089008	25
	27,40	29,90	29,00	29,90	29,00	
Q8 P70 Guarnitura Q8 placca patent 70 <i>Lever handle Q8 on key plate 70</i>	5GM92087001	5GM92087003	5GM92087004	5GM92087007	5GM92087008	25
	27,40	29,90	29,00	29,90	29,00	
Q8 PY85 Guarnitura Q8 placca yale 85 <i>Lever handle Q8 on cyl. plate 85</i>	5GM92088501	5GM92088503	5GM92088504	5GM92088507	5GM92088508	25
	27,40	29,90	29,00	29,90	29,00	
Q8 R Guarnitura Q8 ros. senza bocc. <i>Lever handle Q8 on rose</i>	5GM92280001	5GM92280003	5GM92280004	5GM92280007	5GM92280008	25
	19,80	20,50	20,30	20,50	20,30	
Q8 RB Guarnitura Q8 ros./bocc. patent <i>Lever handle Q8 on rose-key escutcheon</i>	5GM92281001	5GM92281003	5GM92281004	5GM92281007	5GM92281008	25
	21,80	24,40	23,40	24,40	23,40	
Q8 RBY Guarnitura Q8 ros./bocc. Yale <i>Lever handle Q8 on rose-cyl escutcheon</i>	5GM92285001	5GM92285003	5GM92285004	5GM92285007	5GM92285008	25
	21,80	24,40	23,40	24,40	23,40	
Q8 RBWC Guarnitura Q8 ros./bocc.Wc <i>Lever handle Q8 on rose-WC function</i>	5GM92288001	5GM92288003	5GM92288004	5GM92288007	5GM92288008	25
	30,00	35,30	31,70	35,30	31,70	
DK x 40-35 Martellina DK Q7 x 40-35 <i>Window handle Q7 DK-tilt & turn handle</i>	5GM92557001	5GM92557003	5GM92557004	5GM92557007	5GM92557008	50
	12,20	15,00	13,90	15,00	13,90	
DK x 40-35 C/BUSS. Martellina DK Q7 x 40-35 con bussole D. 9,5 <i>Window handle Q7 DK-tilt & turn handle with pins d.9,5</i>	5GM92558001	5GM92558003	5GM92558004	5GM92558007	5GM92558008	50
	12,20	15,00	13,90	15,00	13,90	



OLV-M1

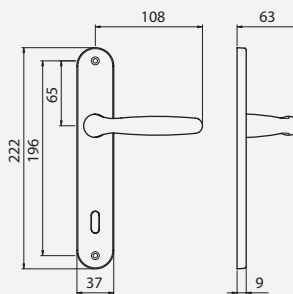

Placca EVA		
38-43		

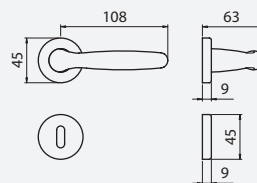

Ros 45x9		
38-43		

A richiesta / On request

38	30
50	50



OCS-M18



OGV-M27



OCL-M4



OS-M2

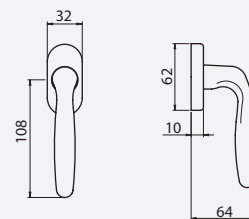

Per maggiori informazioni - For more information:



	OLV M1	OCS M18	OGV M27	OCL M4	OS M2	Conf. pz.
Q8 P90 Guarnitura Q8 placca patent 90 <i>Lever handle Q8 on key plate 90</i>	5GM86089001	5GM86089003	5GM86089004	5GM86089007	5GM86089008	25
	28,40	30,90	29,90	30,90	29,90	
Q8 P70 Guarnitura Q8 placca patent 70 <i>Lever handle Q8 on key plate 70</i>	5GM86087001	5GM86087003	5GM86087004	5GM86087007	5GM86087008	25
	28,40	30,90	29,90	30,90	29,90	
Q8 PY85 Guarnitura Q8 placca yale 85 <i>Lever handle Q8 on cyl. plate 85</i>	5GM86088501	5GM86088503	5GM86088504	5GM86088507	5GM86088508	25
	28,40	30,90	29,90	30,90	29,90	
Q8 R Guarnitura Q8 ros. senza bocc. <i>Lever handle Q8 on rose</i>	5GM86280001	5GM86280003	5GM86280004	5GM86280007	5GM86280008	25
	20,80	21,50	21,20	21,50	21,20	
Q8 RB Guarnitura Q8 ros./bocc. patent <i>Lever handle Q8 on rose-key escutcheon</i>	5GM86281001	5GM86281003	5GM86281004	5GM86281007	5GM86281008	25
	22,80	25,30	24,40	25,30	24,40	
Q8 RBY Guarnitura Q8 ros./bocc. Yale <i>Lever handle Q8 on rose-cyl escutcheon</i>	5GM86285001	5GM86285003	5GM86285004	5GM86285007	5GM86285008	25
	22,80	25,30	24,40	25,30	24,40	
Q8 RBWC Guarnitura Q8 ros./bocc.Wc <i>Lever handle Q8 on rose-WC function</i>	5GM86288001	5GM86288003	5GM86288004	5GM86288007	5GM86288008	25
	31,00	36,20	32,60	36,20	32,60	
DK x 40-35 Martellina DK Q7 x 40-35 <i>Window handle Q7 DK-tilt & turn handle</i>	5GM86557001	5GM86557003	5GM86557004	5GM86557007	5GM86557008	50
	12,40	15,20	14,20	15,20	14,20	
DK x 40-35 C/BUSS. Martellina DK Q7 x 40-35 con bussole D. 9,5 <i>Window handle Q7 DK-tilt & turn handle with pins d.9,5</i>	5GM86558001	5GM86558003	5GM86558004	5GM86558007	5GM86558008	50
	12,40	15,20	14,20	15,20	14,20	

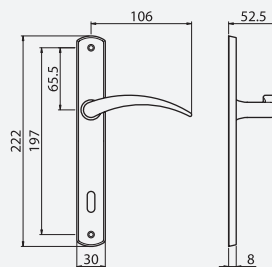
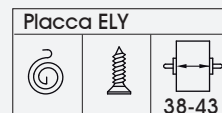
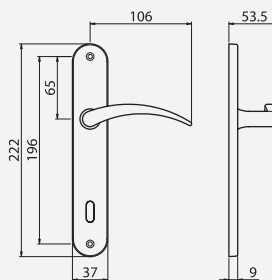

OLV-M1

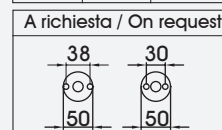
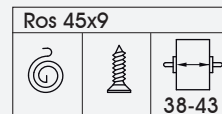
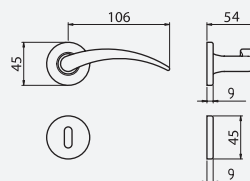

OCS-M18



OGV-M27

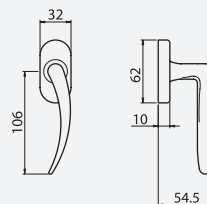
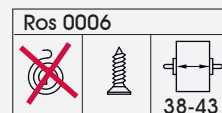
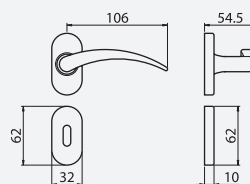

Per maggiori informazioni - For more information:

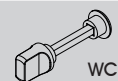

	OLV M1	OCS M18	OGV M27	Conf. pz.
Q8 P90 Guarnitura Q8 placca patent 90 <i>Lever handle Q8 on key plate 90</i>	55020089001	55020089003	55020089004	1
	26,10	30,70	26,80	
Q8 P70 Guarnitura Q8 placca patent 70 <i>Lever handle Q8 on key plate 70</i>	55020087001	55020087003	55020087004	1
	26,10	30,70	26,80	
Q8 PY85 Guarnitura Q8 placca yale 85 <i>Lever handle Q8 on cyl. plate 85</i>	55020088501	55020088503	55020088504	1
	26,10	30,70	26,80	
Q8 P90RS Guarnitura Q8 placca stretta pat 90 <i>Lever handle Q8 on reduced key plate 90</i>	55020051001	55020051003	55020051004	1
	27,20	31,70	27,80	
Q8 P70RS Guarnitura Q8 placca stretta pat 70 <i>Lever handle Q8 on reduced key plate 70</i>	55020057001	55020057003	55020057004	1
	27,20	31,70	27,80	
Q8 PY85RS Guarnitura Q8 placca stretta yale85 <i>Lever handle Q8 on reduced cyl. plate 85</i>	55020055001	55020055003	55020055004	1
	27,20	31,70	27,80	
Q8 R Guarnitura Q8 ros. senza bocc. <i>Lever handle Q8 on rose</i>	55020280001	55020280003	55020280004	1
	17,90	20,10	18,80	
Q8 RB Guarnitura Q8 ros./bocc. patent <i>Lever handle Q8 on rose-key escutcheon</i>	55020281001	55020281003	55020281004	1
	20,50	23,40	21,50	
Q8 RBY Guarnitura Q8 ros./bocc. Yale <i>Lever handle Q8 on rose-cyl escutcheon</i>	55020285001	55020285003	55020285004	1
	20,50	23,40	21,50	
Q8 RBWC Guarnitura Q8 ros./bocc.Wc <i>Lever handle Q8 on rose-WC function</i>	55020288001	55020288003	55020288004	1
	25,70	29,50	28,20	
Q8 ROC Guarnitura Q8 ros.ovale senza bocc. <i>Lever handle Q8 on oval rose</i>	55020220501	55020220503	55020220504	1
	20,00	21,70	20,70	
Q8 RBOC Guarnitura Q8 ros/bocc.ovale patent <i>Lever handle Q8 on oval rose-key escutcheon</i>	55020221501	55020221503	55020221504	1
	24,30	26,60	24,90	
Q8 RBOYC Guarnitura Q8 ros/bocc.ovale Yale <i>Lever handle Q8 on oval rose-cyl escutcheon</i>	55020225501	55020225503	55020225504	1
	24,30	26,60	24,90	
DK x 40-35 Martellina DK Q7 x 40-35 <i>Window handle Q7 DK-tilt & turn handle</i>	55020557001	55020557003	55020557004	2
	11,40	12,10	11,80	
DK x 40-35 C/BUSS. Martellina DK Q7 x 40-35 con bussole D. 9,5 <i>Window handle Q7 DK-tilt & turn handle with pins d.9,5</i>	55020558001	55020558003	55020558004	2
	11,40	12,10	11,80	



OLV-M1



OCS-M18



OCL-M4

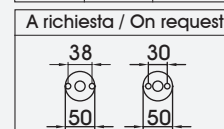
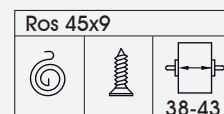
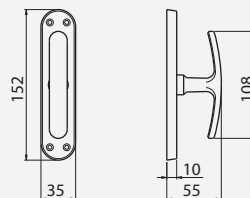
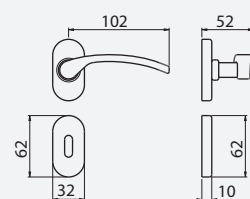
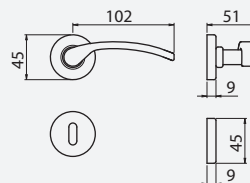
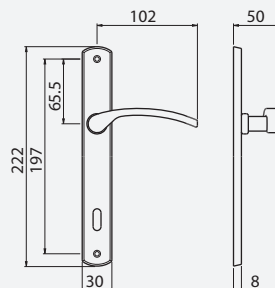
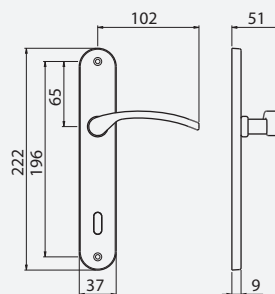

Per maggiori informazioni - For more information:

Rosette da pag. 246 a pag. 257 Roses from pag. 246 to pag. 257
 Placche da pag. 265 a pag. 267 Plates from pag. 265 to pag. 267
 DK da pag. 262 a pag. 264 Window handles from pag. 262 to pag. 264

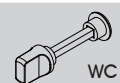

	OLV M1	OCS M18	OCL M4	Conf. pz.
Q8 P90	55450089001	55450089003	55450089007	
Guarnitura Q8 placca patent 90				1
<i>Lever handle Q8 on key plate 90</i>	17,70	24,60	24,60	
Q8 P70	55450087001	55450087003	55450087007	
Guarnitura Q8 placca patent 70				1
<i>Lever handle Q8 on key plate 70</i>	17,70	24,60	24,60	
Q8 PY85	55450088501	55450088503	55450088507	
Guarnitura Q8 placca yale 85				1
<i>Lever handle Q8 on cyl. plate 85</i>	17,70	24,60	24,60	
Q8 P90RS	55450051001	55450051003	55450051007	
Guarnitura Q8 placca stretta pat 90				1
<i>Lever handle Q8 on reduced key plate 90</i>	19,50	27,10	27,10	
Q8 P70RS	55450057001	55450057003	55450057007	
Guarnitura Q8 placca stretta pat 70				1
<i>Lever handle Q8 on reduced key plate 70</i>	19,50	27,10	27,10	
Q8 PY85RS	55450055001	55450055003	55450055007	
Guarnitura Q8 placca stretta yale85				1
<i>Lever handle Q8 on reduced cyl. plate 85</i>	19,50	27,10	27,10	
Q8 R	55450280001	55450280003	55450280007	
Guarnitura Q8 ros. senza bocc.				1
<i>Lever handle Q8 on rose</i>	11,90	17,40	17,40	
Q8 RB	55450281001	55450281003	55450281007	
Guarnitura Q8 ros./bocc. patent				1
<i>Lever handle Q8 on rose-key escutcheon</i>	16,00	22,90	22,90	
Q8 RBY	55450285001	55450285003	55450285007	
Guarnitura Q8 ros./bocc. Yale				1
<i>Lever handle Q8 on rose-cyl escutcheon</i>	16,00	22,90	22,90	
Q8 RBWC	55450288001	55450288003	55450288007	
Guarnitura Q8 ros./bocc.Wc				1
<i>Lever handle Q8 on rose-WC function</i>	22,80	32,50	32,50	
Q8 ROC	55450220501	55450220503	55450220507	
Guarnitura Q8 ros.ovale senza bocc.				1
<i>Lever handle Q8 on oval rose</i>	13,10	19,20	19,20	
Q8 RBOC	55450221501	55450221503	55450221507	
Guarnitura Q8 ros/bocc.ovale patent				1
<i>Lever handle Q8 on oval rose-key escutcheon</i>	17,60	25,20	25,20	
Q8 RBOYC	55450225501	55450225503	55450225507	
Guarnitura Q8 ros/bocc.ovale Yale				1
<i>Lever handle Q8 on oval rose-cyl escutcheon</i>	17,60	25,20	25,20	
EZ	55450406001	55450406003	55450406007	
Cremonese gioco EZ				1
<i>Window handle Q7 with mechanism</i>	9,80	13,20	13,20	
EZQ7	55450407001	55450407003	55450407007	
Cremonese gioco EZ + Q7				1
<i>Window handle Q7 with mechanism</i>	10,10	13,50	13,50	
MART	55450500001	55450500003	55450500007	
Martellina Q7				1
<i>Window handle Q7</i>	9,80	13,20	13,20	



OLV-M1

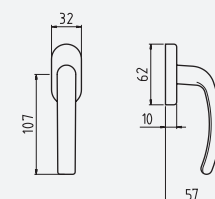
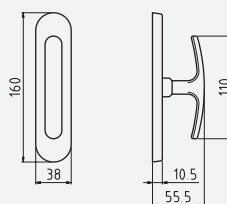
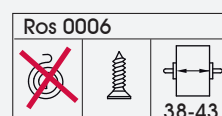
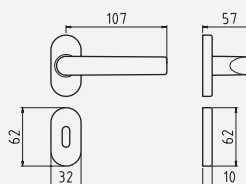
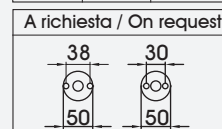
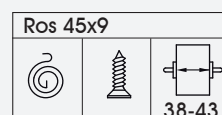
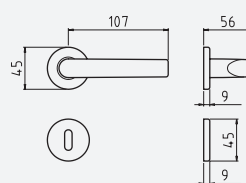
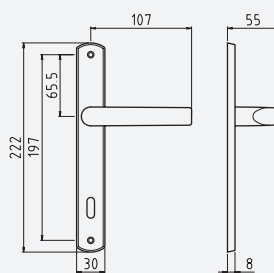
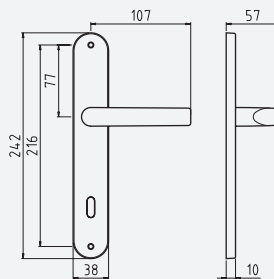

OCS-M18



OCL-M4



Per maggiori informazioni - For more information:

Rosette da pag. 246 a pag. 257
 Placche da pag. 265 a pag. 267
 DK da pag. 262 a pag. 264

Roses from pag. 246 to pag. 257
 Plates from pag. 265 to pag. 267
 Window handles from pag. 262 to pag. 264

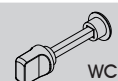

	OLV M1	OCS M18	OCL M4	Conf. pz.	Imb. pz.
Q8 P90 Guarnitura Q8 placca patent 90 <i>Lever handle Q8 on key plate 90</i>	55046089001	55046089003	55046089007	1	20
	23,60	30,40	30,40		
Q8 P70 Guarnitura Q8 placca patent 70 <i>Lever handle Q8 on key plate 70</i>	55046087001	55046087003	55046087007	1	20
	23,60	30,40	30,40		
Q8 PY85 Guarnitura Q8 placca yale 85 <i>Lever handle Q8 on cyl. plate 85</i>	55046088501	55046088503	55046088507	1	20
	23,60	30,40	30,40		
Q8 P90RS Guarnitura Q8 placca stretta pat 90 <i>Lever handle Q8 on reduced key plate 90</i>	55046051001	55046051003	55046051007	1	-
	25,90	33,40	33,40		
Q8 P70RS Guarnitura Q8 placca stretta pat 70 <i>Lever handle Q8 on reduced key plate 70</i>	55046057001	55046057003	55046057007	1	-
	25,90	33,40	33,40		
Q8 PY85RS Guarnitura Q8 placca stretta yale85 <i>Lever handle Q8 on reduced cyl. plate 85</i>	55046055001	55046055003	55046055007	1	-
	25,90	33,40	33,40		
Q8 R Guarnitura Q8 ros. senza bocc. <i>Lever handle Q8 on rose</i>	55046280001	55046280003	55046280007	1	50
	17,80	23,30	23,30		
Q8 RB Guarnitura Q8 ros./bocc. patent <i>Lever handle Q8 on rose-key escutcheon</i>	55046281001	55046281003	55046281007	1	50
	21,90	28,70	28,70		
Q8 RBY Guarnitura Q8 ros./bocc. Yale <i>Lever handle Q8 on rose-cyl escutcheon</i>	55046285001	55046285003	55046285007	1	50
	21,90	28,70	28,70		
Q8 RBWC Guarnitura Q8 ros./bocc.Wc <i>Lever handle Q8 on rose-WC function</i>	55046288001	55046288003	55046288007	1	50
	28,70	38,30	38,30		
Q8 ROC Guarnitura Q8 ros.ovale senza bocc. <i>Lever handle Q8 on oval rose</i>	55046220501	55046220503	55046220507	1	-
	19,30	25,60	25,60		
Q8 RBOC Guarnitura Q8 ros/bocc.ovale patent <i>Lever handle Q8 on oval rose-key escutcheon</i>	55046221501	55046221503	55046221507	1	-
	24,10	31,60	31,60		
Q8 RBOYC Guarnitura Q8 ros/bocc.ovale Yale <i>Lever handle Q8 on oval rose-cyl escutcheon</i>	55046225501	55046225503	55046225507	1	-
	24,10	31,60	31,60		
EZ Cremonese gioco EZ <i>Window handle Q7 with mechanism</i>	55046406001	55046406003	55046406007	2	100
	14,40	17,80	17,80		
EZQ7 Cremonese gioco EZ + Q7 <i>Window handle Q7 with mechanism</i>	55046407001	55046407003	55046407007	2	100
	14,80	18,20	18,20		
MART Martellina Q7 <i>Window handle Q7</i>	55046500001	55046500003	55046500007	2	100
	14,40	17,80	17,80		
DK x 40-35 Martellina DK Q7 x 40-35 <i>Window handle Q7 DK-tilt & turn handle</i>	55046557001	55046557003	55046557007	2	100
	14,40	17,80	17,80		
DK x 40-35 C/BUSS. Martellina DK Q7 x 40-35 con bussole D. 9,5 <i>Window handle Q7 DK-tilt & turn handle with pins D. 9,5</i>	55046558001	55046558003	55046558007	2	100
	14,40	17,80	17,80		



OLV-M1

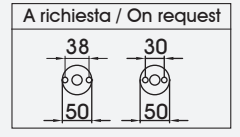
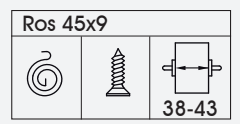
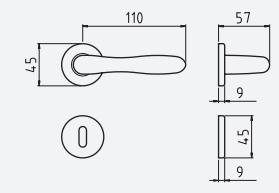
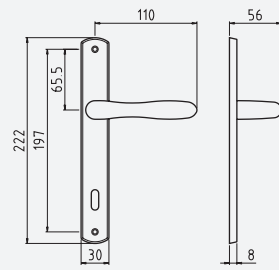
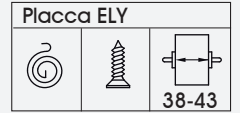
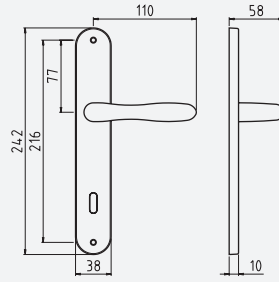

OCS-M18



OCL-M4

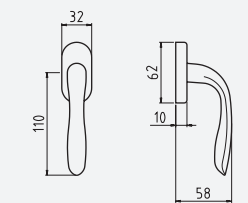
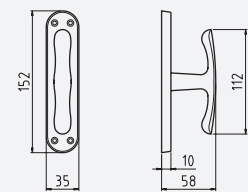
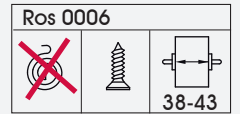
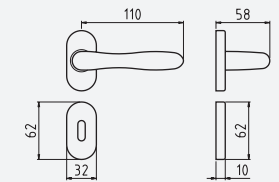

Per maggiori informazioni - For more information:

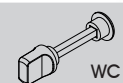

	OLV M1	OCS M18	OCL M4	Conf. pz.	Imb. pz.
Q8 P90 Guarnitura Q8 placca patent 90 <i>Lever handle Q8 on key plate 90</i>	55042089001	55042089003	55042089007	1	20
	24,30	31,10	31,10		
Q8 P70 Guarnitura Q8 placca patent 70 <i>Lever handle Q8 on key plate 70</i>	55042087001	55042087003	55042087007	1	20
	24,30	31,10	31,10		
Q8 PY85 Guarnitura Q8 placca yale 85 <i>Lever handle Q8 on cyl. plate 85</i>	55042088501	55042088503	55042088507	1	20
	24,30	31,10	31,10		
Q8 P90RS Guarnitura Q8 placca stretta pat 90 <i>Lever handle Q8 on reduced key plate 90</i>	55042051001	55042051003	55042051007	1	-
	26,70	34,20	34,20		
Q8 P70RS Guarnitura Q8 placca stretta pat 70 <i>Lever handle Q8 on reduced key plate 70</i>	55042057001	55042057003	55042057007	1	-
	26,70	34,20	34,20		
Q8 PY85RS Guarnitura Q8 placca stretta yale85 <i>Lever handle Q8 on reduced cyl. plate 85</i>	55042055001	55042055003	55042055007	1	-
	26,70	34,20	34,20		
Q8 R Guarnitura Q8 ros. senza bocc. <i>Lever handle Q8 on rose</i>	55042280001	55042280003	55042280007	1	50
	18,50	23,90	23,90		
Q8 RB Guarnitura Q8 ros./bocc. patent <i>Lever handle Q8 on rose-key escutcheon</i>	55042281001	55042281003	55042281007	1	50
	22,60	29,40	29,40		
Q8 RBY Guarnitura Q8 ros./bocc. Yale <i>Lever handle Q8 on rose-cyl escutcheon</i>	55042285001	55042285003	55042285007	1	50
	22,60	29,40	29,40		
Q8 RBWC Guarnitura Q8 ros./bocc.Wc <i>Lever handle Q8 on rose-WC function</i>	55042288001	55042288003	55042288007	1	50
	29,40	39,00	39,00		
Q8 ROC Guarnitura Q8 ros.ovale senza bocc. <i>Lever handle Q8 on oval rose</i>	55042220501	55042220503	55042220507	1	-
	20,30	26,30	26,30		
Q8 RBOC Guarnitura Q8 ros/bocc.ovale patent <i>Lever handle Q8 on oval rose-key escutcheon</i>	55042221501	55042221503	55042221507	1	-
	24,80	32,30	32,30		
Q8 RBOYC Guarnitura Q8 ros/bocc.ovale Yale <i>Lever handle Q8 on oval rose-cyl escutcheon</i>	55042225501	55042225503	55042225507	1	-
	24,80	32,30	32,30		
EZ Cremonese gioco EZ <i>Window handle Q7 with mechanism</i>	55042406001	55042406003	55042406007	2	100
	15,10	18,50	18,50		
EZQ7 Cremonese gioco EZ + Q7 <i>Window handle Q7 with mechanism</i>	55042407001	55042407003	55042407007	2	100
	15,40	18,90	18,90		
MART Martellina Q7 <i>Window handle Q7</i>	55042500001	55042500003	55042500007	2	100
	14,40	17,80	17,80		
DK x 40 Martellina DK Q7 x 40 <i>Window handle Q7 DK-tilt & turn handle</i>	55042557001	55042557003	55042557007	2	100
	15,10	18,50	18,50		
DK x 40 C/BUSS. Martellina DK Q7 x 40 con bussole D. 9,5 <i>Window handle Q7 DK-tilt & turn handle with pins D. 9,5</i>	55042558001	55042558003	55042558007	2	100
	15,10	18,50	18,50		



OLV-M1

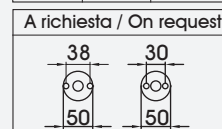
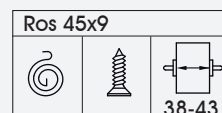
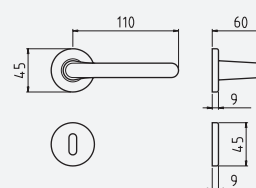
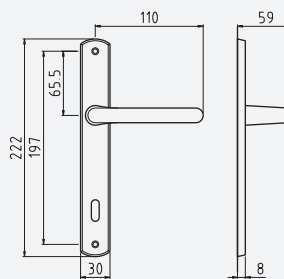
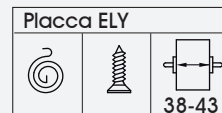
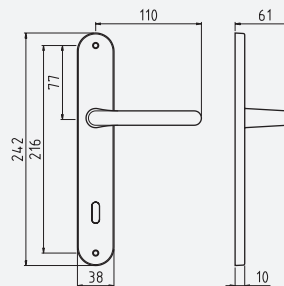

OCS-M18



OCL-M4

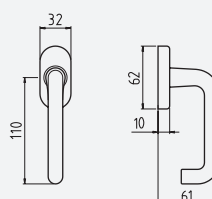
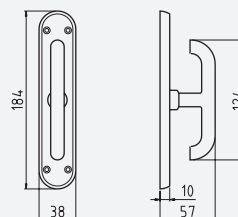
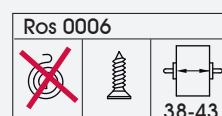
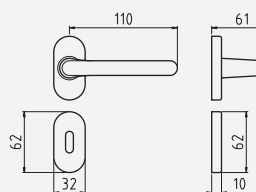

Per maggiori informazioni - For more information:

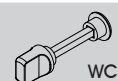

	OLV M1	OCS M18	OCL M4	Conf. pz.	Imb. pz.
Q8 P90	55424089001	55424089003	55424089007		
Guarnitura Q8 placca patent 90	40,30	47,20	47,20	1	20
<i>Lever handle Q8 on key plate 90</i>					
Q8 P70	55424087001	55424087003	55424087007		
Guarnitura Q8 placca patent 70	40,30	47,20	47,20	1	20
<i>Lever handle Q8 on key plate 70</i>					
Q8 PY85	55424088501	55424088503	55424088507		
Guarnitura Q8 placca yale 85	40,30	47,20	47,20	1	20
<i>Lever handle Q8 on cyl. plate 85</i>					
Q8 P90RS	55424051001	55424051003	55424051007		
Guarnitura Q8 placca stretta pat 90	44,40	51,90	51,90	1	-
<i>Lever handle Q8 on reduced key plate 90</i>					
Q8 P70RS	55424057001	55424057003	55424057007		
Guarnitura Q8 placca stretta pat 70	44,40	51,90	51,90	1	-
<i>Lever handle Q8 on reduced key plate 70</i>					
Q8 PY85RS	55424055001	55424055003	55424055007		
Guarnitura Q8 placca stretta yale85	44,40	51,90	51,90	1	-
<i>Lever handle Q8 on reduced cyl. plate 85</i>					
Q8 R	55424280001	55424280003	55424280007		
Guarnitura Q8 ros. senza bocc.	34,50	40,00	40,00	1	50
<i>Lever handle Q8 on rose</i>					
Q8 RB	55424281001	55424281003	55424281007		
Guarnitura Q8 ros./bocc. patent	38,60	45,50	45,50	1	50
<i>Lever handle Q8 on rose-key escutcheon</i>					
Q8 RBY	55424285001	55424285003	55424285007		
Guarnitura Q8 ros./bocc. Yale	38,60	45,50	45,50	1	50
<i>Lever handle Q8 on rose-cyl escutcheon</i>					
Q8 RBWC	55424288001	55424288003	55424288007		
Guarnitura Q8 ros./bocc.Wc	45,50	55,00	55,00	1	50
<i>Lever handle Q8 on rose-WC function</i>					
Q8 ROC	55424220501	55424220503	55424220507		
Guarnitura Q8 ros.ovale senza bocc.	38,00	44,00	44,00	1	-
<i>Lever handle Q8 on oval rose</i>					
Q8 RBOC	55424221501	55424221503	55424221507		
Guarnitura Q8 ros/bocc.ovale patent	42,50	50,00	50,00	1	-
<i>Lever handle Q8 on oval rose-key escutcheon</i>					
Q8 RBOYC	55424225501	55424225503	55424225507		
Guarnitura Q8 ros/bocc.ovale Yale	42,50	50,00	50,00	1	-
<i>Lever handle Q8 on oval rose-cyl escutcheon</i>					
EZ	55424406001	55424406003	55424406007		
Cremonese gioco EZ	24,40	27,80	27,80	2	100
<i>Window handle Q7 with mechanism</i>					
EZQ7	55424407001	55424407003	55424407007		
Cremonese gioco EZ + Q7	24,80	28,20	28,20	2	100
<i>Window handle Q7 with mechanism</i>					
MART	55424500001	55424500003	55424500007		
Martellina Q7	23,70	27,10	27,10	2	100
<i>Window handle Q7</i>					
DK x 40-35	55424557001	55424557003	55424557007		
Martellina DK Q7 x 40-35	24,40	27,80	27,80	2	100
<i>Window handle Q7 DK-tilt & turn handle</i>					
DK x 40-35 C/BUSS.	55424558001	55424558003	55424558007		
Martellina DK Q7 x 40-35 con bussole D. 9,5	24,40	27,80	27,80	2	100
<i>Window handle Q7 DK-tilt & turn handle with pins D. 9,5</i>					



OLV-M1

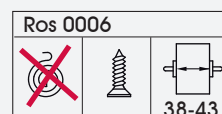
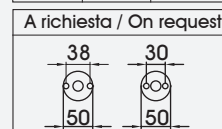
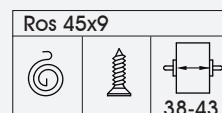
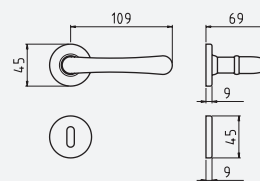
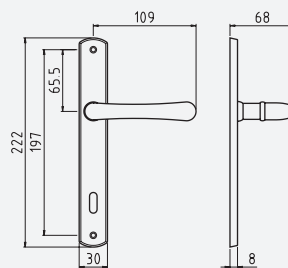
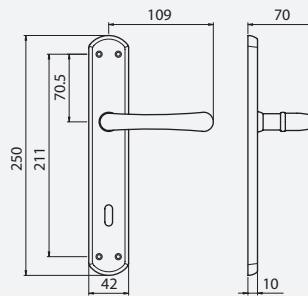

OLS-M33



OGV-M27

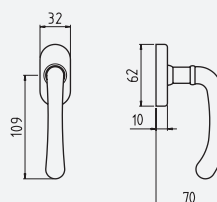
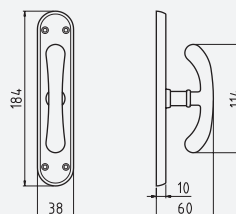
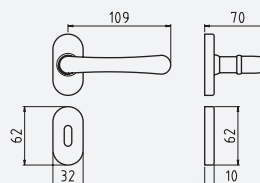

Per maggiori informazioni - For more information:

Rosette da pag. 246 a pag. 257 Roses from pag. 246 to pag. 257
 Placche da pag. 265 a pag. 267 Plates from pag. 265 to pag. 267
 DK da pag. 262 a pag. 264 Window handles from pag. 262 to pag. 264

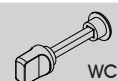

	OLV M1	OLS M33	OGV M27	Conf. pz.	Imb. pz.
Q8 P90 Guarnitura Q8 placca patent 90 <i>Lever handle Q8 on key plate 90</i>	55446089001	55446089002	55446089004	1	20
	29,10	29,10	29,10		
Q8 P70 Guarnitura Q8 placca patent 70 <i>Lever handle Q8 on key plate 70</i>	55446087001	55446087002	55446087004	1	20
	29,10	29,10	29,10		
Q8 PY85 Guarnitura Q8 placca yale 85 <i>Lever handle Q8 on cyl. plate 85</i>	55446088501	55446088502	55446088504	1	20
	29,10	29,10	29,10		
Q8 P90RS Guarnitura Q8 placca stretta pat 90 <i>Lever handle Q8 on reduced key plate 90</i>	55446051001	55446051002	55446051004	1	-
	32,00	32,00	32,00		
Q8 P70RS Guarnitura Q8 placca stretta pat 70 <i>Lever handle Q8 on reduced key plate 70</i>	55446057001	55446057002	55446057004	1	-
	32,00	32,00	32,00		
Q8 PY85RS Guarnitura Q8 placca stretta yale85 <i>Lever handle Q8 on reduced cyl. plate 85</i>	55446055001	55446055002	55446055004	1	-
	32,00	32,00	32,00		
Q8 R Guarnitura Q8 ros. senza bocc. <i>Lever handle Q8 on rose</i>	55446280001	55446280002	55446280004	1	50
	23,30	23,30	23,30		
Q8 RB Guarnitura Q8 ros./bocc. patent <i>Lever handle Q8 on rose-key escutcheon</i>	55446281001	55446281002	55446281004	1	50
	27,40	27,40	27,40		
Q8 RBY Guarnitura Q8 ros./bocc. Yale <i>Lever handle Q8 on rose-cyl escutcheon</i>	55446285001	55446285002	55446285004	1	50
	27,40	27,40	27,40		
Q8 RBWC Guarnitura Q8 ros./bocc.Wc <i>Lever handle Q8 on rose-WC function</i>	55446288001	55446288002	55446288004	1	50
	34,20	34,20	34,20		
Q8 ROC Guarnitura Q8 ros.ovale senza bocc. <i>Lever handle Q8 on oval rose</i>	55446220501	55446220502	55446220504	1	-
	25,60	25,60	25,60		
Q8 RBOC Guarnitura Q8 ros/bocc.ovale patent <i>Lever handle Q8 on oval rose-key escutcheon</i>	55446221501	55446221502	55446221504	1	-
	30,10	30,10	30,10		
Q8 RBOYC Guarnitura Q8 ros/bocc.ovale Yale <i>Lever handle Q8 on oval rose-cyl escutcheon</i>	55446225501	55446225502	55446225504	1	-
	30,10	30,10	30,10		
EZ Cremonese gioco EZ <i>Window handle Q7 with mechanism</i>	55446406001	55446406002	55446406004	2	100
	18,50	18,50	18,50		
EZQ7 Cremonese gioco EZ + Q7 <i>Window handle Q7 with mechanism</i>	55446407001	55446407002	55446407004	2	100
	18,90	18,90	18,90		
MART Martellina Q7 <i>Window handle Q7</i>	55446500001	55446500002	55446500004	2	100
	17,80	17,80	17,80		
DK x 40 Martellina DK Q7 x 40 <i>Window handle Q7 DK-tilt & turn handle</i>	55446557001	55446557002	55446557004	2	100
	18,50	18,50	18,50		
DK x 40 C/BUSS. Martellina DK Q7 x 40 con bussole D. 9,5 <i>Window handle Q7 DK-tilt & turn handle with pins D. 9,5</i>	55446558001	55446558002	55446558004	2	100
	18,50	18,50	18,50		

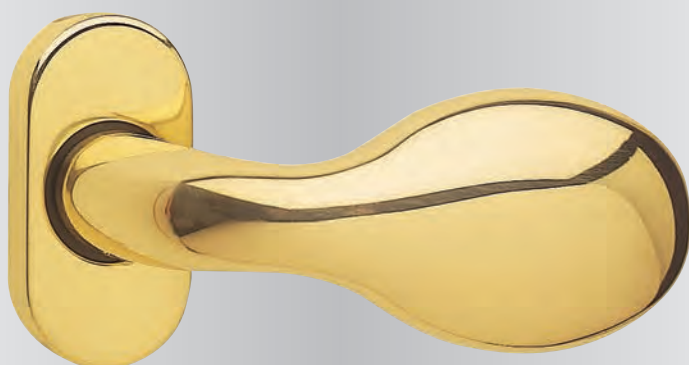

OLV-M1

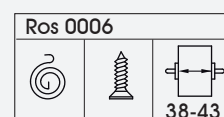
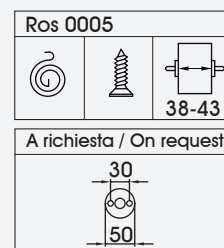
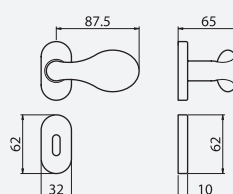
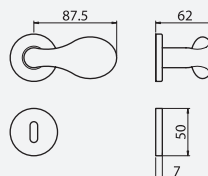

	OLV M1	OCS M18	OCL M4	G-PLUS M36	Conf. pz.
PS Q8 RBT Pomolo spostato Q8 ros.bocc.patent <i>Offset knob on rose key escutcheon</i>	55696702201	55696702203	55696702207	55696702250	1
	43,00	50,30	50,30	72,10	
PS Q8 RBYT Pomolo spostato Q8 ros.bocc.yale <i>Offset knob on rose cyl. escutcheon</i>	55696702601	55696702603	55696702607	55696702650	1
	43,00	50,30	50,30	72,10	
PS Q8 RBOC Pomolo spostato Q8 ros.bocc.ovale copr.patent <i>Offset knob on oval rose key escutcheon</i>	55696702301	55696702303	55696702307	55696702350	1
	47,30	55,30	55,30	79,40	
PS Q8 RBOYC Pomolo spostato Q8 ros.bocc.ovale copr.yale <i>Offset knob on oval rose cyl. escutcheon</i>	55696702701	55696702703	55696702707	55696702750	1
	47,30	55,30	55,30	79,40	



OLV-M1

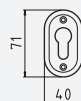
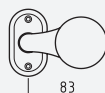
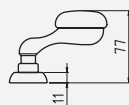
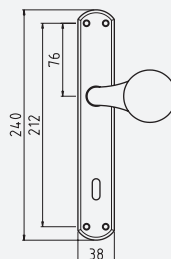
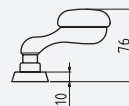

	OLV M1	OGV M27	OS M2	Conf. pz.
PS Q8 P90 Pomolo spostato Q8 placca patent 90 <i>Offset knob on plate</i>	55744700101	55744700104	55744700108	1
	48,20	48,20	48,20	
PS Q8 PY85 Pomolo spostato Q8 placca yale 85 <i>Offset knob handle on plate with cyl.hole</i>	55744700501	55744700504	55744700508	1
	48,20	48,20	48,20	
PS Q8 RB Pomolo spostato Q8 ros./bocc. patent <i>Offset knob on rose key escutcheon</i>	55744702101	55744702104	55744702108	2
	48,20	48,20	48,20	
PS Q8 RBY Pomolo spostato Q8 ros./bocc.Yale <i>Offset knob on rose cyl. escutcheon</i>	55744702501	55744702504	55744702508	2
	48,20	48,20	48,20	



OLV-M1

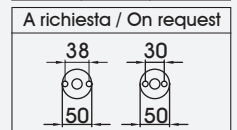
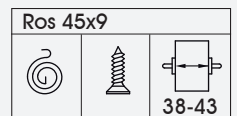
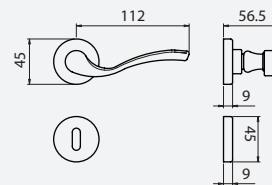
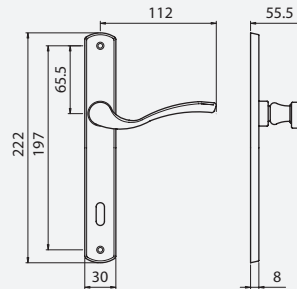
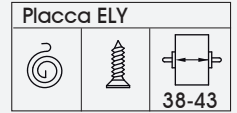
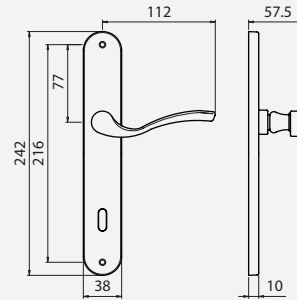

OGV-M27

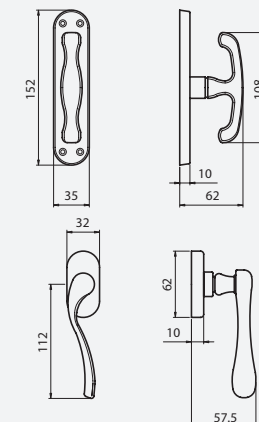
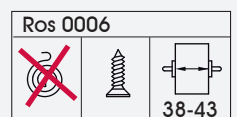
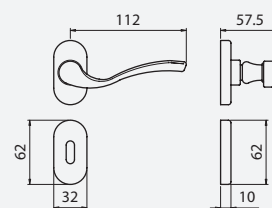

Per maggiori informazioni - For more information:

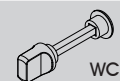

	OLV M1	OGV M27	Conf. pz.
Q8 P90 Guarnitura Q8 placca patent 90 <i>Lever handle Q8 on key plate 90</i>	55010089001 30,30	55010089004 30,90	1
Q8 P70 Guarnitura Q8 placca patent 70 <i>Lever handle Q8 on key plate 70</i>	55010087001 30,30	55010087004 30,90	1
Q8 PY85 Guarnitura Q8 placca yale 85 <i>Lever handle Q8 on cyl. plate 85</i>	55010088501 30,30	55010088504 30,90	1
Q8 P90RS Guarnitura Q8 placca stretta pat 90 <i>Lever handle Q8 on reduced key plate 90</i>	55010051001 31,40	55010051004 31,90	1
Q8 P70RS Guarnitura Q8 placca stretta pat 70 <i>Lever handle Q8 on reduced key plate 70</i>	55010057001 31,40	55010057004 31,90	1
Q8 PY85RS Guarnitura Q8 placca stretta yale85 <i>Lever handle Q8 on reduced cyl. plate 85</i>	55010055001 31,40	55010055004 31,90	1
Q8 R Guarnitura Q8 ros. senza bocc. <i>Lever handle Q8 on rose</i>	55010280001 22,10	55010280004 22,40	1
Q8 RB Guarnitura Q8 ros./bocc. patent <i>Lever handle Q8 on rose-key escutcheon</i>	55010281001 24,80	55010281004 25,10	1
Q8 RBY Guarnitura Q8 ros./bocc. Yale <i>Lever handle Q8 on rose-cyl escutcheon</i>	55010285001 24,80	55010285004 25,10	1
Q8 RBWC Guarnitura Q8 ros./bocc.Wc <i>Lever handle Q8 on rose-WC function</i>	55010288001 30,00	55010288004 31,90	1
Q8 ROC Guarnitura Q8 ros.ovale senza bocc. <i>Lever handle Q8 on oval rose</i>	55010220501 24,20	55010220504 24,50	1
Q8 RBOC Guarnitura Q8 ros/bocc.ovale patent <i>Lever handle Q8 on oval rose-key escutcheon</i>	55010221501 28,50	55010221504 28,80	1
Q8 RBOYC Guarnitura Q8 ros/bocc.ovale yale <i>Lever handle Q8 on oval rose-cyl escutcheon</i>	55010225501 28,50	55010225504 28,80	1
MART Martellina Q7 <i>Window handle Q7</i>	55010500001 17,90	55010500004 18,10	2
DK x 40 Martellina DK Q7 x 40 <i>Window handle Q7 DK-tilt & turn handle</i>	55010557001 14,70	55010557004 14,90	2
DK x 40 C/BUSS. Martellina DK Q7 x 40 con bussole D. 9,5 <i>Window handle Q7 DK-tilt & turn handle with pins d.9,5</i>	55010558001 14,70	55010558004 14,90	2

Tutte le versioni cremonesi e martellina sono realizzabili applicando alla martellina i giochi disponibili a pag. 245



OLV-M1

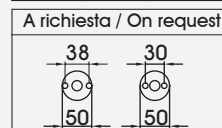
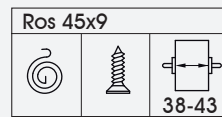
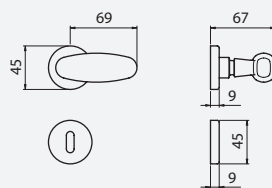
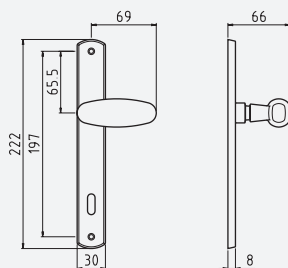
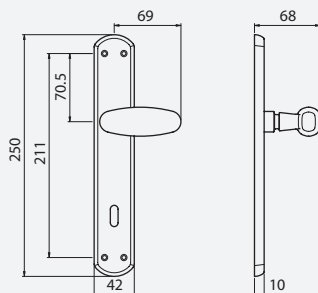

OCS-M18



OGV-M27

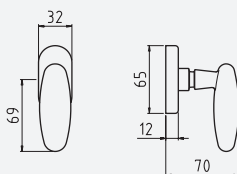
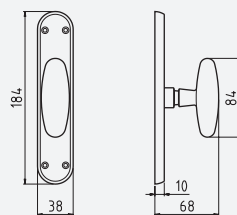
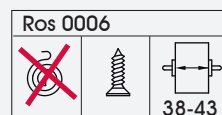
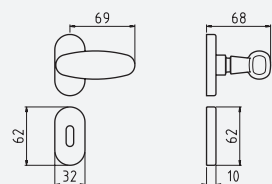

Per maggiori informazioni - For more information:

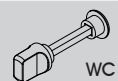

	OLV M1	OCS M18	OGV M27	Conf. pz.
Q8 P90	55434089001	55434089003	55434089004	
Guarnitura Q8 placca patent 90				1
<i>Lever handle Q8 on key plate 90</i>	47,20	54,00	47,20	
Q8 P70	55434087001	55434087003	55434087004	
Guarnitura Q8 placca patent 70				1
<i>Lever handle Q8 on key plate 70</i>	47,20	54,00	47,20	
Q8 PY85	55434088501	55434088503	55434088504	
Guarnitura Q8 placca yale 85				1
<i>Lever handle Q8 on cyl. plate 85</i>	47,20	54,00	47,20	
Q8 P90RS	55434051001	55434051003	55434051004	
Guarnitura Q8 placca stretta pat 90				1
<i>Lever handle Q8 on reduced key plate 90</i>	51,90	59,40	51,90	
Q8 P70RS	55434057001	55434057003	55434057004	
Guarnitura Q8 placca stretta pat 70				1
<i>Lever handle Q8 on reduced key plate 70</i>	51,90	59,40	51,90	
Q8 PY85RS	55434055001	55434055003	55434055004	
Guarnitura Q8 placca stretta yale85				1
<i>Lever handle Q8 on reduced cyl. plate 85</i>	51,90	59,40	51,90	
Q8 R	55434280001	55434280003	55434280004	
Guarnitura Q8 ros. senza bocc.				1
<i>Lever handle Q8 on rose</i>	41,40	46,80	41,40	
Q8 RB	55434281001	55434281003	55434281004	
Guarnitura Q8 ros./bocc. patent				1
<i>Lever handle Q8 on rose-key escutcheon</i>	45,50	52,30	45,50	
Q8 RBY	55434285001	55434285003	55434285004	
Guarnitura Q8 ros./bocc. Yale				1
<i>Lever handle Q8 on rose-cyl escutcheon</i>	45,50	52,30	45,50	
Q8 RBWC	55434288001	55434288003	55434288004	
Guarnitura Q8 ros./bocc.Wc				1
<i>Lever handle Q8 on rose-WC function</i>	52,30	61,80	52,30	
Q8 ROC	55434220501	55434220503	55434220504	
Guarnitura Q8 ros.ovale senza bocc.				1
<i>Lever handle Q8 on oval rose</i>	45,50	51,50	45,50	
Q8 RBOC	55434221501	55434221503	55434221504	
Guarnitura Q8 ros/bocc.ovale patent				1
<i>Lever handle Q8 on oval rose-key escutcheon</i>	50,00	57,50	50,00	
Q8 RBOYC	55434225501	55434225503	55434225504	
Guarnitura Q8 ros/bocc.ovale Yale				1
<i>Lever handle Q8 on oval rose-cyl escutcheon</i>	50,00	57,50	50,00	
EZ	55434406001	55434406003	55434406004	
Cremonese gioco EZ				2
<i>Window handle Q7 with mechanism</i>	30,40	33,90	30,40	
EZQ7	55434407001	55434407003	55434407004	
Cremonese gioco EZ + Q7				2
<i>Window handle Q7 with mechanism</i>	30,80	34,20	30,80	
MART	55434500001	55434500003	55434500004	
Martellina Q7				2
<i>Window handle Q7</i>	29,80	33,20	29,80	
DK x 40	55434557001	55434557003	55434557004	
Martellina DK Q7 x 40				2
<i>Window handle Q7 DK-tilt & turn handle</i>	30,40	33,90	30,40	



OLV-M1

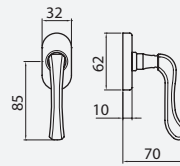
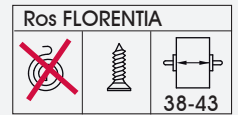
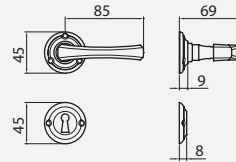

OBR-M45



OLNV-M23



OLD-MV3



Per maggiori informazioni - For more information:

	OBR M45	OLV M1	OLNV M23	OLD MV3	Conf. pz.
Q8 RVV	55638250000	55638250001	55638280020	55638250028	
Guarnitura Q8 ros. senza bocc.	23,60	24,60	23,60	23,60	1
<i>Lever handle Q8 on rose</i>					
Q8 RBVV	55638251000	55638251001	55638281020	55638251028	
Guarnitura Q8 ros./bocc. patent	30,00	31,40	30,00	30,00	1
<i>Lever handle Q8 on rose-key escutcheon</i>					
Q8 RBWCVV	55638258000	55638258001	55638288020	55638258028	
Guarnitura Q8 ros./bocc. Wc	35,90	37,90	35,90	35,90	1
<i>Lever handle Q8 on rose-WC function</i>					
DK x 40	55638557000	55638557001	55638557020	55638557028	
Martellina DK Q7 x 40	12,20	12,70	12,20	12,20	2
<i>Window handle Q7 DK-tilt & turn handle</i>					
DK x 40 C/BUSS. 9,5	55638558000	55638558001	55638558020	55638558028	
Martellina DK Q7 x 40 con bussole D.9,5	12,20	12,70	12,20	12,20	2
<i>Window handle Q7 DK-tilt & turn handle with pins D.9,5</i>					



OLV/PB-C1

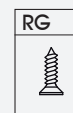
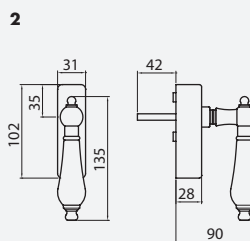
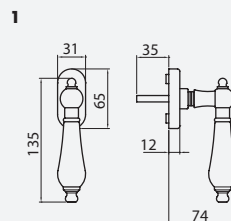
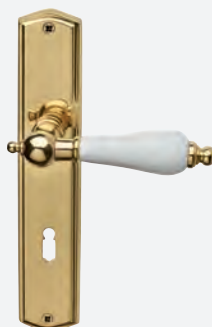
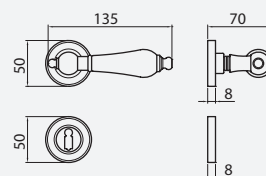
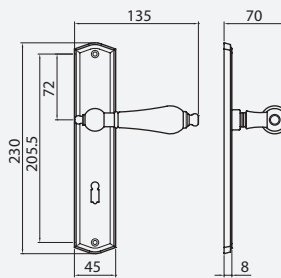

Per maggiori informazioni - For more information:



	OLV / PB C1	OCS / PB C18	OCL / PB C4	OCS / PN X18	Conf. pz.
39/46 Q8 BB72 VL Guarnitura Q8 placca BB 72 con viti legno <i>Lever handle Q8 on key plate 72 with wood screw</i>	R0039004673C1	R0039004673C3	R0039004673C7	R0039004673X3	1
	44,50	46,10	46,10	46,50	
39/46 Q8 PZ72 VL Guarnitura Q8 placca Yale 72 con viti legno <i>Lever handle Q8 on cyl. plate 72 with wood screw</i>	R0039004677C1	R0039004677C3	R0039004677C7	R0039004677X3	1
	44,50	46,10	46,10	46,50	
39/46 Q8 WC78 Q8 VL Guarnitura Q8 placca WC 78 Q8 viti legno <i>Lever handle Q8 on WC Q8 function plate 78 with wood screw</i>	R0039004698C1	R0039004698C3	R0039004698C7	R0039004698X3	1
	52,30	53,90	53,90	54,80	
39/65/Q8 R VL Guarnitura Q8 ros. senza bocc. con viti legno <i>Lever handle Q8 on rose with wood screw</i>	R0039006505C160	R0039006505C360	R0039006505C760	R0039006505X360	1
	44,45	58,15	58,15	58,65	
39/65/660 Q8 RB BB VL Guarnitura Q8 ros./bocc. BB con viti legno <i>Lever handle Q8 on rose-key escutcheon with wood screw</i>	R0039006512C160	R0039006512C360	R0039006512C760	R0039006512X360	1
	55,85	70,85	70,85	73,65	
39/65/660 Q8 RB PZ VL Guarnitura Q8 ros./bocc. Yale con viti legno <i>Lever handle Q8 on rose-cyl escutcheon with wood screw</i>	R0039006550C160	R0039006550C360	R0039006550C760	R0039006550X360	1
	55,85	70,85	70,85	73,65	
39/65/65 Q8 RB WC Q8 VL Guarnitura Q8 ros./bocc. WC Q8 con viti legno <i>Lever handle Q8 on rose-WC Q8 function with wood screw</i>	R0039006588C160	R0039006588C360	R0039006588C760	R0039006588X360	1
	65,65	81,75	81,75	84,45	
39/65/Q8 R VPM Guarnitura Q8 ros. senza bocc. viti passanti metriche <i>Lever handle Q8 on rose with metric-thread screw</i>	R0039006505C142	R0039006505C342	R0039006505C742	R0039006505X342	1
	44,70	58,40	58,40	58,90	
39/65/660 Q8 RB BB VPM Guarnitura Q8 ros./bocc. BB viti passanti metriche <i>Lever handle Q8 on rose-key escutcheon with metric-thread screw</i>	R0039006512C142	R0039006512C342	R0039006512C742	R0039006512X342	1
	56,10	71,10	71,10	73,90	
39/65/660 Q8 RB PZ VPM Guarnitura Q8 ros./bocc. Yale viti passanti metriche <i>Lever handle Q8 on rose-cyl escutcheon with metric-thread screw</i>	R0039006550C142	R0039006550C342	R0039006550C742	R0039006550X342	1
	56,10	71,10	71,10	73,90	
39/65/65 Q8 RB WC Q8 VPM Guarnitura Q8 ros./bocc. WC Q8 viti passanti metriche <i>Lever handle Q8 on rose-WC Q8 function with metric-thread screw</i>	R0039006588C142	R0039006588C342	R0039006588C742	R0039006588X342	1
	65,90	82,00	82,00	84,70	
39/0004 DK x 35 VM C/BUSS. 1 Martellina DK Q7 x 35 con bussole D.9,5 mm viti metriche <i>Window handle Q7 DK-tilt & turn handle with pins D.9,5 / metric-thread screw</i>	R0039000480C190	R0039000480C390	R0039000480C790	R0039000480X390	1
	22,50	25,80	25,80	25,90	
39/00A4 DK x 42 C/CHIAVE VM C/BUSS. 2 Martellina con chiave DK Q7 x 42 con bussole D.9,5 mm viti metriche <i>Window handle Q7 DK-tilt & turn handle with key with pins D.9,5 / metric-thread screw</i>	R003900A484C190	R003900A484C390	R003900A484C790	R003900A484X390	1
	78,00	78,50	78,50	78,60	



OLV/PI-P1

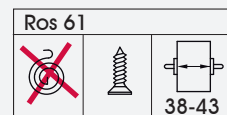
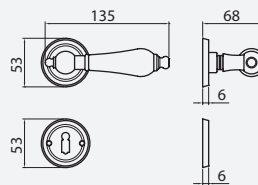

1

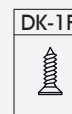
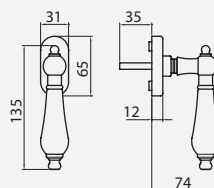

2

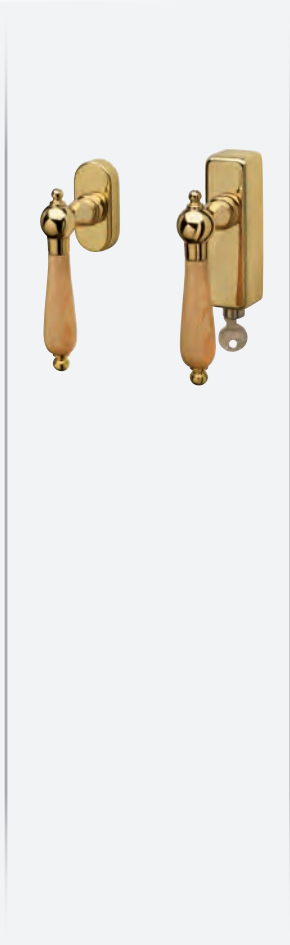
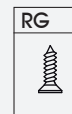
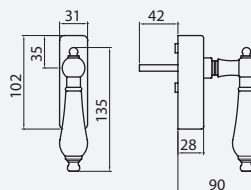

Per maggiori informazioni - For more information:



	OLV / PI P1	Conf. pz.
39/61 Q8 R VL Guarnitura Q8 ros. senza bocc. con viti legno <i>Lever handle Q8 on rose with wood screw</i>	R0039006105P160 42,70	1
39/61/62 Q8 RB BB VL Guarnitura Q8 ros./bocc. BB con viti legno <i>Lever handle Q8 on rose-key escutcheon with wood screw</i>	R0039006112P160 51,40	1
39/61/62 Q8 RB PZ VL Guarnitura Q8 ros./bocc. Yale con viti legno <i>Lever handle Q8 on rose-cyl escutcheon with wood screw</i>	R0039006150P160 51,40	1
39/61/61 Q8 RB WC Q8 VL Guarnitura Q8 ros./bocc. WC Q8 con viti legno <i>Lever handle Q8 on rose-WC Q8 function with wood screw</i>	R0039006188P160 62,00	1
39/0004 DK x 35 VM C/BUSS.	R0039000480P190	
1 Martellina DK Q7 x 35 con bussole D.9,5 mm viti metriche <i>Window handle Q7 DK-tilt & turn handle with pins D.9,5 / metric-thread screw</i>	20,80	1
39/00A4 DK x 42 C/CHIAVE VM C/BUSS.	R003900A484P190	
2 Martellina con chiave DK Q7 x 42 con bussole D.9,5 mm viti metriche <i>Window handle Q7 DK-tilt & turn handle with key with pins D.9,5 / metric-thread screw</i>	73,90	1



OLV-M1

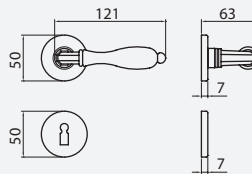

Ros 0005		
38-43		
A richiesta / On request		



OCL-M4



OLD-MV3



OFA-M69



OANT-M75

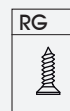
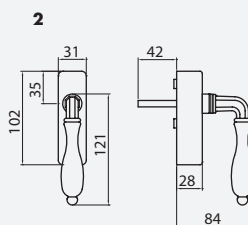
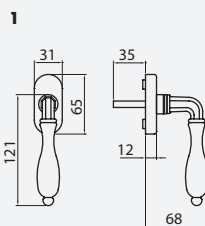

Per maggiori informazioni - For more information:



	OLV M1	OCL M4	OLD MV3	OFA M69	OANT M75	Conf. pz.
901/0005 Q8 R VL Guarnitura Q8 ros. senza bocc. con viti legno <i>Lever handle Q8 on rose with wood screw</i>	R09010005050160	R09010005050760	R09010005052860	R09010005052960	R09010005054260	1
	38,90	39,70	30,90	40,05	38,90	
901/0005 Q8 RB BB VL Guarnitura Q8 ros./bocc. BB con viti legno <i>Lever handle Q8 on rose-key escutcheon with wood screw</i>	R09010005120160	R09010005120760	R09010005122860	R09010005122960	R09010005124260	1
	41,10	42,00	32,40	42,30	41,10	
901/0005 Q8 RB PZ VL Guarnitura Q8 ros./bocc. Yale con viti legno <i>Lever handle Q8 on rose-cyl escutcheon with wood screw</i>	R09010005500160	R09010005500760	R09010005502860	R09010005502960	R09010005504260	1
	41,10	42,00	32,40	42,30	41,10	
901/0005 Q8 RB WC Q8 VL Guarnitura Q8 ros./bocc. WC Q8 con viti legno <i>Lever handle Q8 on rose-WC Q8 function with wood screw</i>	R09010005880160	R09010005880760	R09010005882860	R09010005882960	R09010005884260	1
	48,80	50,00	39,10	49,90	48,80	
901/0005 Q8 R C/BUSS. VPA Guarnitura Q8 ros. senza bocc. con buss. viti passanti autofilettanti <i>Lever handle Q8 on rose with pins / thread forming screw</i>	R090100050501	R090100050507	R090100050528	R090100050529	R090100050542	1
	39,15	39,95	31,15	40,30	39,15	
901/0005 Q8 RB BB C/BUSS. VPA Guarnitura Q8 ros./bocc. BB con buss. viti passanti autofilettanti <i>Lever handle Q8 on rose-key escutcheon with pins / thread forming screw</i>	R090100051201	R090100051207	R090100051228	R090100051229	R090100051242	1
	41,35	42,25	32,65	42,55	41,35	
901/0005 Q8 RB PZ C/BUSS. VPA Guarnitura Q8 ros./bocc. Yale con buss. viti passanti autofilettanti <i>Lever handle Q8 on rose-cyl escutcheon with pins / thread forming screw</i>	R090100055001	R090100055007	R090100055028	R090100055029	R090100055042	1
	41,35	42,25	32,65	42,55	41,35	
901/0005 Q8 RB WC Q8 C/BUSS. VPA Guarnitura Q8 ros./bocc. WC Q8 con buss. viti passanti autofilettanti <i>Lever handle Q8 on rose-WC Q8 function with pins / thread forming screw</i>	R090100058801	R090100058807	R090100058828	R090100058829	R090100058842	1
	49,05	50,25	39,35	50,15	49,05	
901/0004 DK x 35 VM C/BUSS. 1 Martellina DK Q7 x 35 con bussole D.9,5 mm viti metriche <i>Window handle Q7 DK-tilt & turn handle with pins D.9,5 / metric-thread screw</i>	R09010004800190	R09010004800790	R09010004802890	R09010004802990	R09010004804290	1
	29,10	29,90	23,30	30,00	29,10	
901/00A4 DK x 42 C/CHIAVE VM C/BUSS. 2 Martellina con chiave DK Q7 x 42 con bussole D.9,5 mm viti metriche <i>Window handle Q7 DK-tilt & turn handle with key with pins D.9,5 / metric-thread screw</i>	R090100A4840190	R090100A4840790	R090100A4842890	R090100A4842990	R090100A4844290	1
	81,90	82,50	63,30	82,60	81,90	



OLV-M1

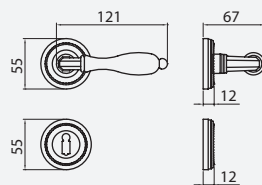
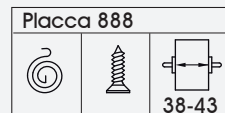
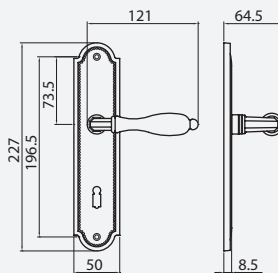

OCL-M4



OLD-MV3



OFA-M69



OANT-M75



Per maggiori informazioni - For more information:



	OLV M1	OCL M4	OLD MV3	OFA M69	OANT M75	Conf. pz.
901/888 Q8 BB72 VL Guarnitura Q8 placca BB 72 con viti legno <i>Lever handle Q8 on key plate 72 with wood screw</i>	R090108887301 103,00	R090108887307 104,90	R090108887328 88,50	R090108887329 105,00	R090108887342 103,00	1
901/888 Q8 PZ72 VL Guarnitura Q8 placca Yale 72 con viti legno <i>Lever handle Q8 on cyl. plate 72 with wood screw</i>	R090108887701 103,00	R090108887707 104,90	R090108887728 88,50	R090108887729 105,00	R090108887742 103,00	1
901/888 Q8 WC78 Q8 VL Guarnitura Q8 placca WC 78 Q8 viti legno <i>Lever handle Q8 on WC Q8 function plate 78 with wood screw</i>	R090108889801 113,50	R090108889807 115,60	R090108889828 97,60	R090108889829 115,70	R090108889842 113,50	1
901/558 Q8 R VL Guarnitura Q8 ros. senza bocc. con viti legno <i>Lever handle Q8 on rose with wood screw</i>	R09010558050160 75,35	R09010558050760 76,65	R09010558052860 61,55	R09010558052960 76,75	R09010558054260 75,35	1
901/558 Q8 RB BB VL Guarnitura Q8 ros./bocc. BB con viti legno <i>Lever handle Q8 on rose-key escutcheon with wood screw</i>	R09010558120160 101,15	R09010558120760 103,25	R09010558122860 83,85	R09010558122960 103,35	R09010558124260 101,15	1
901/558 Q8 RB PZ VL Guarnitura Q8 ros./bocc. Yale con viti legno <i>Lever handle Q8 on rose-cyl escutcheon with wood screw</i>	R09010558500160 101,15	R09010558500760 103,25	R09010558502860 83,85	R09010558502960 103,35	R09010558504260 101,15	1
901/558 Q8 RB WC Q8 VL Guarnitura Q8 ros./bocc. WC Q8 con viti legno <i>Lever handle Q8 on rose-WC Q8 function with wood screw</i>	R09010558880160 110,75	R09010558880760 113,15	R09010558882860 92,15	R09010558882960 113,25	R09010558884260 110,75	1
901/558 Q8 R C/BUSS. VPM Guarnitura Q8 ros. senza bocc. con buss. viti passanti metriche <i>Lever handle Q8 on rose with pins / metric-thread screw</i>	R09010558050140 75,60	R09010558050740 76,90	R09010558052840 61,80	R09010558052940 77,00	R09010558054240 75,60	1
901/558 Q8 RB BB C/BUSS. VPM Guarnitura Q8 ros./bocc. BB con buss. viti passanti metriche <i>Lever handle Q8 on rose-key escutcheon with pins / metric-thread screw</i>	R09010558120140 101,40	R09010558120740 103,50	R09010558122840 84,10	R09010558122940 103,60	R09010558124240 101,40	1
901/558 Q8 RB PZ C/BUSS. VPM Guarnitura Q8 ros./bocc. Yale con buss. viti passanti metriche <i>Lever handle Q8 on rose-cyl escutcheon with pins / metric-thread screw</i>	R09010558500140 101,40	R09010558500740 103,50	R09010558502840 84,10	R09010558502940 103,60	R09010558504240 101,40	1
901/558 Q8 RB WC Q8 C/BUSS. VPM Guarnitura Q8 ros./bocc. WC Q8 con buss. viti passanti metriche <i>Lever handle Q8 on rose-WC Q8 function with pins / metric-thread screw</i>	R09010558880140 111,00	R09010558880740 113,40	R09010558882840 92,40	R09010558882940 113,50	R09010558884240 111,00	1



OLS-M33

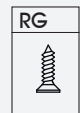
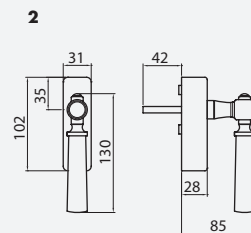
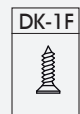
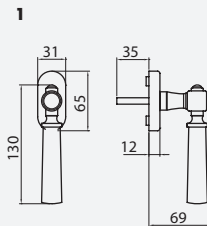
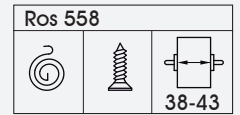
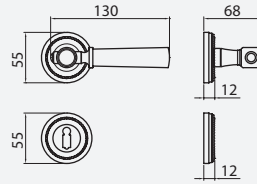

Per maggiori informazioni - For more information:



	OLS M33	OCL/OCS M60	Conf. pz.
974/558 Q8 R VL Guarnitura Q8 ros. senza bocc. con viti legno <i>Lever handle Q8 on rose with wood screw</i>	R09740558050260 83,85	R09740558055960 85,55	1
974/558 Q8 RB BB VL Guarnitura Q8 ros./bocc. BB con viti legno <i>Lever handle Q8 on rose-key escutcheon with wood screw</i>	R09740558120260 109,55	R09740558125960 112,15	1
974/558 Q8 RB PZ VL Guarnitura Q8 ros./bocc. Yale con viti legno <i>Lever handle Q8 on rose-cyl escutcheon with wood screw</i>	R09740558500260 109,55	R09740558505960 112,15	1
974/558 Q8 RB WC Q8 VL Guarnitura Q8 ros./bocc. WC Q8 con viti legno <i>Lever handle Q8 on rose-WC Q8 function with wood screw</i>	R09740558880260 119,25	R09740558885960 122,15	1
974/558 Q8 R C/BUSS. VPM Guarnitura Q8 ros. senza bocc. con buss. viti passanti metriche <i>Lever handle Q8 on rose with pins / metric-thread screw</i>	R09740558050240 84,10	R09740558055940 85,80	1
974/558 Q8 RB BB C/BUSS. VPM Guarnitura Q8 ros./bocc. BB con buss. viti passanti metriche <i>Lever handle Q8 on rose-key escutcheon with pins / metric-thread screw</i>	R09740558120240 109,80	R09740558125940 112,40	1
974/558 Q8 RB PZ C/BUSS. VPM Guarnitura Q8 ros./bocc. Yale con buss. viti passanti metriche <i>Lever handle Q8 on rose-cyl escutcheon with pins / metric-thread screw</i>	R09740558500240 109,80	R09740558505940 112,40	1
974/558 Q8 RB WC Q8 C/BUSS. VPM Guarnitura Q8 ros./bocc. WC Q8 con buss. viti passanti metriche <i>Lever handle Q8 on rose-WC Q8 function with pins / metric-thread screw</i>	R09740558880240 119,50	R09740558885940 122,40	1
974/0004 DK x 35 VM C/BUSS. 1 Martellina DK Q7 x 35 con bussole D.9,5 mm viti metriche <i>Window handle Q7 DK-tilt & turn handle with pins D.9,5 / metric-thread screw</i>	R09740004800290 33,50	R09740004805990 34,30	1
974/00A4 DK x 42 C/CHIAVE VM C/BUSS. 2 Martellina con chiave DK Q7 x 42 con bussole D.9,5 mm viti metriche <i>Window handle Q7 DK-tilt & turn handle with key with pins D.9,5 / metric-thread screw</i>	R097400A4840290 86,30	R097400A4845990 86,90	1



OLV-M1

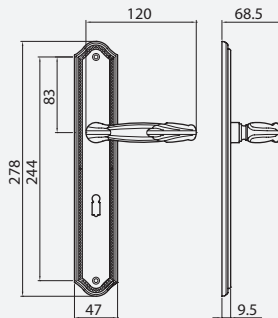

Placca 883		
38-43		

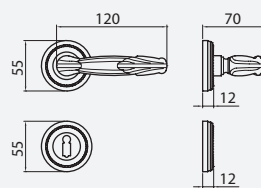

Ros 558		
38-43		



OFA-M69

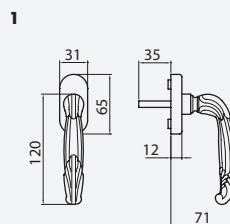

DK-1F

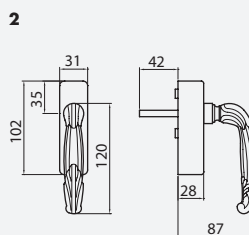

RG

Per maggiori informazioni - For more information:



	OLV M1	OFA M69	Conf. pz.
983/883 Q8 BB72 VL Guarnitura Q8 placca BB 72 con viti legno <i>Lever handle Q8 on key plate 72 with wood screw</i>	R098308837301 80,80	R098308837329 82,60	1
983/883 Q8 PZ72 VL Guarnitura Q8 placca Yale 72 con viti legno <i>Lever handle Q8 on cyl. plate 72 with wood screw</i>	R098308837701 80,80	R098308837729 82,60	1
983/883 Q8 WC78 Q8 VL Guarnitura Q8 placca WC 78 Q8 viti legno <i>Lever handle Q8 on WC Q8 function plate 78 with wood screw</i>	R098308839801 91,40	R098308839829 93,00	1
983/558 Q8 R VL Guarnitura Q8 ros. senza bocc. con viti legno <i>Lever handle Q8 on rose with wood screw</i>	R09830558050160 68,75	R09830558052960 70,85	1
983/558 Q8 RB BB VL Guarnitura Q8 ros./bocc. BB con viti legno <i>Lever handle Q8 on rose-key escutcheon with wood screw</i>	R09830558120160 94,55	R09830558122960 98,15	1
983/558 Q8 RB PZ VL Guarnitura Q8 ros./bocc. Yale con viti legno <i>Lever handle Q8 on rose-cyl escutcheon with wood screw</i>	R09830558500160 94,55	R09830558502960 98,15	1
983/558 Q8 RB WC Q8 VL Guarnitura Q8 ros./bocc. WC Q8 con viti legno <i>Lever handle Q8 on rose-WC Q8 function with wood screw</i>	R09830558880160 104,05	R09830558882960 107,45	1
983/558 Q8 R C/BUSS. VPM Guarnitura Q8 ros. senza bocc. con buss. viti passanti metriche <i>Lever handle Q8 on rose with pins / metric-thread screw</i>	R09830558050140 69,00	R09830558052940 71,10	1
983/558 Q8 RB BB C/BUSS. VPM Guarnitura Q8 ros./bocc. BB con buss. viti passanti metriche <i>Lever handle Q8 on rose-key escutcheon with pins / metric-thread screw</i>	R09830558120140 94,80	R09830558122940 98,40	1
983/558 Q8 RB PZ C/BUSS. VPM Guarnitura Q8 ros./bocc. Yale con buss. viti passanti metriche <i>Lever handle Q8 on rose-cyl escutcheon with pins / metric-thread screw</i>	R09830558500140 94,80	R09830558502940 98,40	1
983/558 Q8 RB WC Q8 C/BUSS. VPM Guarnitura Q8 ros./bocc. WC Q8 con buss. viti passanti metriche <i>Lever handle Q8 on rose-WC Q8 function with pins / metric-thread screw</i>	R09830558880140 104,30	R09830558882940 107,70	1
983/0004 DK x 35 VM C/BUSS. 1 Martellina DK Q7 x 35 con bussole D.9,5 mm viti metriche <i>Window handle Q7 DK-tilt & turn handle with pins D.9,5 / metric-thread screw</i>	R09830004800190 25,90	R09830004802990 27,30	1
983/00A4 DK x 42 C/CHIAVE VM C/BUSS. 2 Martellina con chiave DK Q7 x 42 con bussole D.9,5 mm viti metriche <i>Window handle Q7 DK-tilt & turn handle with key with pins D.9,5 / metric-thread screw</i>	R098300A4840190 78,80	R098300A4842990 83,15	1



OLV-M1

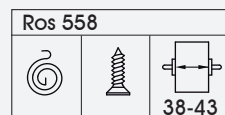
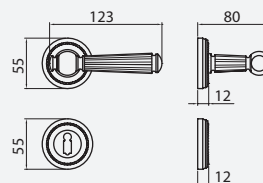
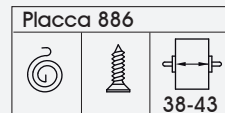
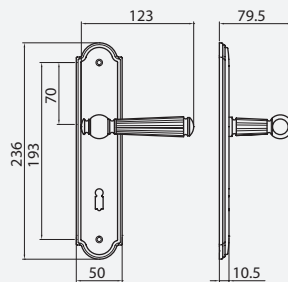

OCL-M4

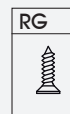
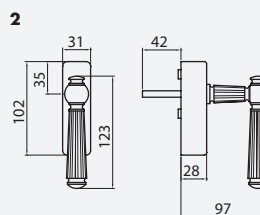
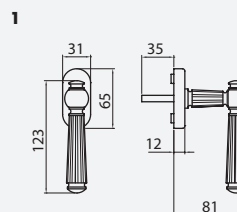

Per maggiori informazioni - For more information:



	OLV M1	OCL M4	Conf. pz.
984/886 Q8 BB72 VL Guarnitura Q8 placca BB 72 con viti legno <i>Lever handle Q8 on key plate 72 with wood screw</i>	R098408867301 102,40	R098408867307 104,50	1
984/886 Q8 PZ72 VL Guarnitura Q8 placca Yale 72 con viti legno <i>Lever handle Q8 on cyl. plate 72 with wood screw</i>	R098408867701 102,40	R098408867707 104,50	1
984/886 Q8 WC78 Q8 VL Guarnitura Q8 placca WC 78 Q8 viti legno <i>Lever handle Q8 on WC Q8 function plate 78 with wood screw</i>	R098408869801 113,00	R098408869807 115,20	1
984/558 Q8 R VL Guarnitura Q8 ros. senza bocc. con viti legno <i>Lever handle Q8 on rose with wood screw</i>	R09840558050160 87,75	R09840558050760 89,25	1
984/558 Q8 RB BB VL Guarnitura Q8 ros./bocc. BB con viti legno <i>Lever handle Q8 on rose-key escutcheon with wood screw</i>	R09840558120160 113,65	R09840558120760 116,05	1
984/558 Q8 RB PZ VL Guarnitura Q8 ros./bocc. Yale con viti legno <i>Lever handle Q8 on rose-cyl escutcheon with wood screw</i>	R09840558500160 113,65	R09840558500760 116,05	1
984/558 Q8 RB WC Q8 VL Guarnitura Q8 ros./bocc. WC Q8 con viti legno <i>Lever handle Q8 on rose-WC Q8 function with wood screw</i>	R09840558880160 123,25	R09840558880760 125,75	1
984/558 Q8 R C/BUSS. VPM Guarnitura Q8 ros. senza bocc. con buss. viti passanti metriche <i>Lever handle Q8 on rose with pins / metric-thread screw</i>	R09840558050140 88,00	R09840558050740 89,50	1
984/558 Q8 RB BB C/BUSS. VPM Guarnitura Q8 ros./bocc. BB con buss. viti passanti metriche <i>Lever handle Q8 on rose-key escutcheon with pins / metric-thread screw</i>	R09840558120140 113,90	R09840558120740 116,30	1
984/558 Q8 RB PZ C/BUSS. VPM Guarnitura Q8 ros./bocc. Yale con buss. viti passanti metriche <i>Lever handle Q8 on rose-cyl escutcheon with pins / metric-thread screw</i>	R09840558500140 113,90	R09840558500740 116,30	1
984/558 Q8 RB WC Q8 C/BUSS. VPM Guarnitura Q8 ros./bocc. WC Q8 con buss. viti passanti metriche <i>Lever handle Q8 on rose-WC Q8 function with pins / metric-thread screw</i>	R09840558880140 123,50	R09840558880740 126,00	1
984/0004 DK x 35 VM C/BUSS. 1 Martellina DK Q7 x 35 con bussole D.9,5 mm viti metriche <i>Window handle Q7 DK-tilt & turn handle with pins D.9,5 / metric-thread screw</i>	R09840004800190 35,30	R09840004800790 36,10	1
984/00A4 DK x 42 C/CHIAVE VM C/BUSS. 2 Martellina con chiave DK Q7 x 42 con bussole D.9,5 mm viti metriche <i>Window handle Q7 DK-tilt & turn handle with key with pins D.9,5 / metric-thread screw</i>	R098400A4840190 88,20	R098400A4840790 88,90	1



OCL/PB-C4

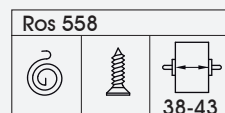
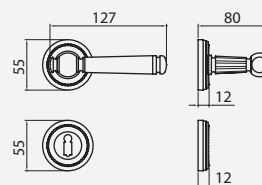
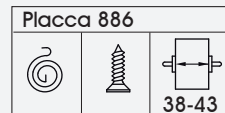
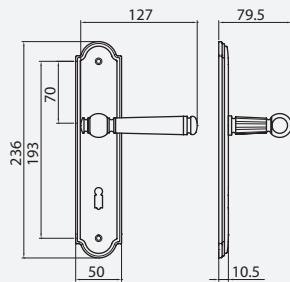

OLV/PB-C1



OLV/LN-D1



OCL/LN-D4

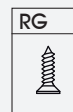
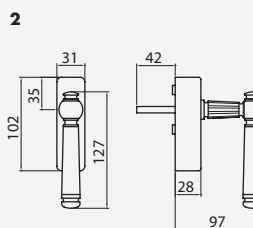
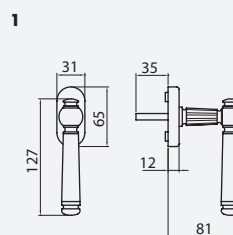

Per maggiori informazioni - For more information:



	OLV / PB C1	OCL / PB C4	OLV / LN D1	OCL / LN D4	Conf. pz.
984/886 Q8 BB72 VL Guarnitura Q8 placca BB 72 con viti legno <i>Lever handle Q8 on key plate 72 with wood screw</i>	R0984088673C1	R0984088673C7	R0984088673D1	R0984088673D7	1
	97,50	99,40	93,00	94,80	
984/886 Q8 PZ72 VL Guarnitura Q8 placca Yale 72 con viti legno <i>Lever handle Q8 on cyl. plate 72 with wood screw</i>	R0984088677C1	R0984088677C7	R0984088677D1	R0984088677D7	1
	97,50	99,40	93,00	94,80	
984/886 Q8 WC78 Q8 VL Guarnitura Q8 placca WC 78 Q8 viti legno <i>Lever handle Q8 on WC Q8 function plate 78 with wood screw</i>	R0984088698C1	R0984088698C7	R0984088698D1	R0984088698D7	1
	108,10	108,40	103,50	103,90	
984/558 Q8 R VL Guarnitura Q8 ros. senza bocc. con viti legno <i>Lever handle Q8 on rose with wood screw</i>	R0984055805C160	R0984055805C760	R0984055805D160	R0984055805D760	1
	83,35	84,65	78,75	80,05	
984/558 Q8 RB BB VL Guarnitura Q8 ros./bocc. BB con viti legno <i>Lever handle Q8 on rose-key escutcheon with wood screw</i>	R0984055812C160	R0984055812C760	R0984055812D160	R0984055812D760	1
	109,15	111,35	104,65	106,75	
984/558 Q8 RB PZ VL Guarnitura Q8 ros./bocc. Yale con viti legno <i>Lever handle Q8 on rose-cyl escutcheon with wood screw</i>	R0984055850C160	R0984055850C760	R0984055850D160	R0984055850D760	1
	109,15	111,35	104,65	106,75	
984/558 Q8 RB WC Q8 VL Guarnitura Q8 ros./bocc. WC Q8 con viti legno <i>Lever handle Q8 on rose-WC Q8 function with wood screw</i>	R0984055888C160	R0984055888C760	R0984055888D160	R0984055888D760	1
	118,85	121,25	114,25	116,55	
984/558 Q8 R C/BUSS. VPM Guarnitura Q8 ros. senza bocc. con buss. viti passanti metriche <i>Lever handle Q8 on rose with pins / metric-thread screw</i>	R0984055805C140	R0984055805C740	R0984055805D140	R0984055805D740	1
	83,60	84,90	79,00	80,30	
984/558 Q8 RB BB C/BUSS. VPM Guarnitura Q8 ros./bocc. BB con buss. viti passanti metriche <i>Lever handle Q8 on rose-key escutcheon with pins / metric-thread screw</i>	R0984055812C140	R0984055812C740	R0984055812D140	R0984055812D740	1
	109,40	111,60	104,90	107,00	
984/558 Q8 RB PZ C/BUSS. VPM Guarnitura Q8 ros./bocc. Yale con buss. viti passanti metriche <i>Lever handle Q8 on rose-cyl escutcheon with pins / metric-thread screw</i>	R0984055850C140	R0984055850C740	R0984055850D140	R0984055850D740	1
	109,40	111,60	104,90	107,00	
984/558 Q8 RB WC Q8 C/BUSS. VPM Guarnitura Q8 ros./bocc. WC Q8 con buss. viti passanti metriche <i>Lever handle Q8 on rose-WC Q8 function with pins / metric-thread screw</i>	R0984055888C140	R0984055888C740	R0984055888D140	R0984055888D740	1
	119,10	121,50	114,50	116,80	
984/0004 DK x 35 VM C/BUSS. 1 Martellina DK Q7 x 35 con bussole D.9,5 mm viti metriche <i>Window handle Q7 DK-tilt & turn handle with pins D.9,5 / metric-thread screw</i>	R0984000480C190	R0984000480C790	R0984000480D190	R0984000480D790	1
	33,00	33,60	30,60	31,40	
984/00A4 DK x 42 C/CHIAVE VM C/BUSS. 2 Martellina con chiave DK Q7 x 42 con bussole D.9,5 mm viti metriche <i>Window handle Q7 DK-tilt & turn handle with key with pins D.9,5 / metric-thread screw</i>	R098400A484C190	R098400A484C790	R098400A484D190	R098400A484D790	1
	85,80	86,30	83,40	84,00	



OFA-M69

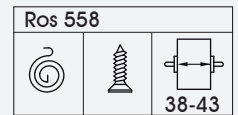
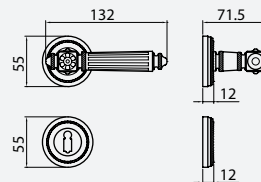
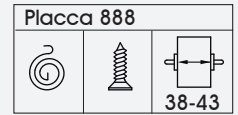
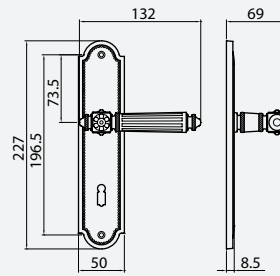

OLV-M1

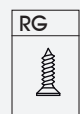
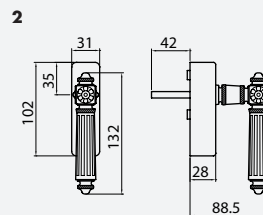
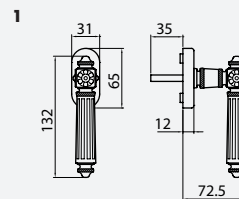

Per maggiori informazioni - For more information:



	OLV M1	OFA M69	Conf. pz.
993/888 Q8 BB72 VL Guarnitura Q8 placca BB 72 con viti legno <i>Lever handle Q8 on key plate 72 with wood screw</i>	R099308887301 116,50	R099308887329 118,50	1
993/888 Q8 PZ72 VL Guarnitura Q8 placca Yale 72 con viti legno <i>Lever handle Q8 on cyl. plate 72 with wood screw</i>	R099308887701 116,50	R099308887729 118,50	1
993/888 Q8 WC78 Q8 VL Guarnitura Q8 placca WC 78 Q8 viti legno <i>Lever handle Q8 on WC Q8 function plate 78 with wood screw</i>	R099308889801 126,90	R099308889829 128,80	1
993/558 Q8 R VL Guarnitura Q8 ros. senza bocc. con viti legno <i>Lever handle Q8 on rose with wood screw</i>	R09930558050160 88,75	R09930558052960 91,15	1
993/558 Q8 RB BB VL Guarnitura Q8 ros./bocc. BB con viti legno <i>Lever handle Q8 on rose-key escutcheon with wood screw</i>	R09930558120160 114,55	R09930558122960 118,35	1
993/558 Q8 RB PZ VL Guarnitura Q8 ros./bocc. Yale con viti legno <i>Lever handle Q8 on rose-cyl escutcheon with wood screw</i>	R09930558500160 114,55	R09930558502960 118,35	1
993/558 Q8 RB WC Q8 VL Guarnitura Q8 ros./bocc. WC Q8 con viti legno <i>Lever handle Q8 on rose-WC Q8 function with wood screw</i>	R09930558880160 124,15	R09930558882960 127,75	1
993/558 Q8 R C/BUSS. VPM Guarnitura Q8 ros. senza bocc. con buss. viti passanti metriche <i>Lever handle Q8 on rose with pins / metric-thread screw</i>	R09930558050140 89,00	R09930558052940 91,40	1
993/558 Q8 RB BB C/BUSS. VPM Guarnitura Q8 ros./bocc. BB con buss. viti passanti metriche <i>Lever handle Q8 on rose-key escutcheon with pins / metric-thread screw</i>	R09930558120140 114,80	R09930558122940 118,60	1
993/558 Q8 RB PZ C/BUSS. VPM Guarnitura Q8 ros./bocc. Yale con buss. viti passanti metriche <i>Lever handle Q8 on rose-cyl escutcheon with pins / metric-thread screw</i>	R09930558500140 114,80	R09930558502940 118,60	1
993/558 Q8 RB WC Q8 C/BUSS. VPM Guarnitura Q8 ros./bocc. WC Q8 con buss. viti passanti metriche <i>Lever handle Q8 on rose-WC Q8 function with pins / metric-thread screw</i>	R09930558880140 124,40	R09930558882940 128,00	1
993/0004 DK x 35 VM C/BUSS. 1 Martellina DK Q7 x 35 con bussole D.9,5 mm viti metriche <i>Window handle Q7 DK-tilt & turn handle with pins D.9,5 / metric-thread screw</i>	R09930004800190 35,90	R09930004802990 37,40	1
993/00A4 DK x 42 C/CHIAVE VM C/BUSS. 2 Martellina con chiave DK Q7 x 42 con bussole D.9,5 mm viti metriche <i>Window handle Q7 DK-tilt & turn handle with key with pins D.9,5 / metric-thread screw</i>	R099300A4840190 88,80	R099300A4842990 91,45	1



OCS/PB-C18

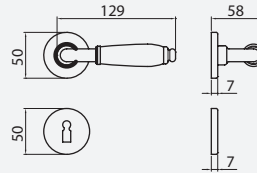

Ros 0005		
		38-43
A richiesta / On request		
 30 50		



OCL/PB-C4



ONL/NO-M72



OFA/NO-M86

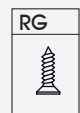
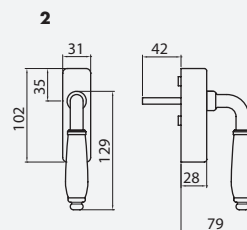
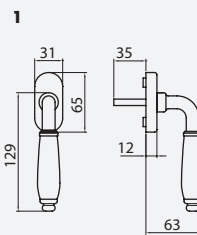

Per maggiori informazioni - For more information:



R5200

	OCS / PB C18	OCL / PB C4	ONL / NO M72	OFA / NO M86	Conf. pz.
5200/0005 Q8 R VL Guarnitura Q8 ros. senza bocc. con viti legno <i>Lever handle Q8 on rose with wood screw</i>	R5200000505C360	R5200000505C760	R5200000505UN60	R5200000505UF60	1
	50,55	50,55	47,55	49,45	
5200/0005 Q8 RB BB VL Guarnitura Q8 ros./bocc. BB con viti legno <i>Lever handle Q8 on rose-key escutcheon with wood screw</i>	R5200000512C360	R5200000512C760	R5200000512UN60	R5200000512UF60	1
	53,95	53,95	51,55	54,65	
5200/0005 Q8 RB PZ VL Guarnitura Q8 ros./bocc. Yale con viti legno <i>Lever handle Q8 on rose-cyl escutcheon with wood screw</i>	R5200000550C360	R5200000550C760	R5200000550UN60	R5200000550UF60	1
	53,95	53,95	51,55	54,65	
5200/0005 Q8 RB WC Q8 VL Guarnitura Q8 ros./bocc. WC Q8 con viti legno <i>Lever handle Q8 on rose-WC Q8 function with wood screw</i>	R5200000588C360	R5200000588C760	R5200000588UN60	R5200000588UF60	1
	64,95	64,95	62,45	65,05	
5200/0005 Q8 R C/BUSS. VPA Guarnitura Q8 ros. senza bocc. con buss. viti passanti autofilettanti <i>Lever handle Q8 on rose with pins / thread forming screw</i>	R5200000505C3	R5200000505C7	R5200000505UN	R5200000505UF	1
	50,80	50,80	47,80	49,70	
5200/0005 Q8 RB BB C/BUSS. VPA Guarnitura Q8 ros./bocc. BB con buss. viti passanti autofilettanti <i>Lever handle Q8 on rose-key escutcheon with pins / thread forming screw</i>	R5200000512C3	R5200000512C7	R5200000512UN	R5200000512UF	1
	54,20	54,20	51,80	54,90	
5200/0005 Q8 RB PZ C/BUSS. VPA Guarnitura Q8 ros./bocc. Yale con buss. viti passanti autofilettanti <i>Lever handle Q8 on rose-cyl escutcheon with pins / thread forming screw</i>	R5200000550C3	R5200000550C7	R5200000550UN	R5200000550UF	1
	54,20	54,20	51,80	54,90	
5200/0005 Q8 RB WC Q8 C/BUSS. VPA Guarnitura Q8 ros./bocc. WC Q8 con buss. viti passanti autofilettanti <i>Lever handle Q8 on rose-WC Q8 function with pins / thread forming screw</i>	R5200000588C3	R5200000588C7	R5200000588UN	R5200000588UF	1
	65,20	65,20	62,70	65,30	
5200/0004 DK x 35 VM C/BUSS. 1 Martellina DK Q7 x 35 con bussole D.9,5 mm viti metriche <i>Window handle Q7 DK-tilt & turn handle with pins D.9,5 / metric-thread screw</i>	R5200000480C390	R5200000480C790	R5200000480UN90	R5200000480UF90	1
	27,80	27,80	26,40	28,35	
5200/00A4 DK x 42 C/CHIAVE VM C/BUSS. 2 Martellina con chiave DK Q7 x 42 con bussole D.9,5 mm viti metriche <i>Window handle Q7 DK-tilt & turn handle with key with pins D.9,5 / metric-thread screw</i>	R520000A484C390	R520000A484C790	R520000A484UN90	R520000A484UF90	1
	80,50	80,50	78,80	82,10	



OLV-M1

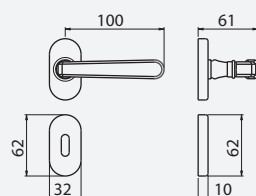
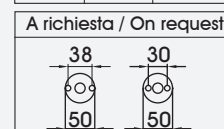
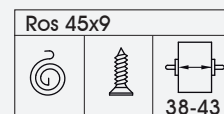
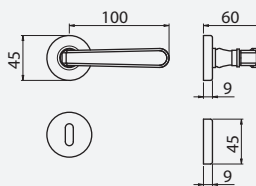
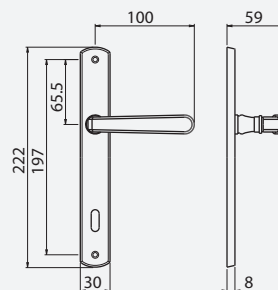
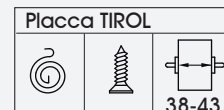
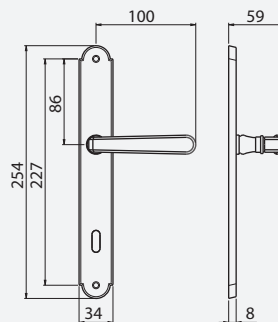

OCS-M18



OCL-M4

Per maggiori informazioni - For more information:

Rosette da pag. 246 a pag. 257
 Placche da pag. 265 a pag. 267
 DK da pag. 262 a pag. 264

Roses from pag. 246 to pag. 257
 Plates from pag. 265 to pag. 267
 Window handles from pag. 262 to pag. 264

	OLV M1	OCS M18	OCL M4	Conf. pz.
Q8 P90	55452089001	55452089003	55452089007	
Guarnitura Q8 placca patent 90				1
<i>Lever handle Q8 on key plate 90</i>	26,40	34,30	34,30	
Q8 P70	55452087001	55452087003	55452087007	
Guarnitura Q8 placca patent 70				1
<i>Lever handle Q8 on key plate 70</i>	26,40	34,30	34,30	
Q8 PY85	55452088501	55452088503	55452088507	
Guarnitura Q8 placca yale 85				1
<i>Lever handle Q8 on cyl. plate 85</i>	26,40	34,30	34,30	
Q8 P90RS	55452051001	55452051003	55452051007	
Guarnitura Q8 placca stretta pat 90				1
<i>Lever handle Q8 on reduced key plate 90</i>	29,10	37,80	37,80	
Q8 P70RS	55452057001	55452057003	55452057007	
Guarnitura Q8 placca stretta pat 70				1
<i>Lever handle Q8 on reduced key plate 70</i>	29,10	37,80	37,80	
Q8 PY85RS	55452055001	55452055003	55452055007	
Guarnitura Q8 placca stretta yale85				1
<i>Lever handle Q8 on reduced cyl. plate 85</i>	29,10	37,80	37,80	
Q8 R	55452280001	55452280003	55452280007	
Guarnitura Q8 ros. senza bocc.				1
<i>Lever handle Q8 on rose</i>	20,60	26,60	26,60	
Q8 RB	55452281001	55452281003	55452281007	
Guarnitura Q8 ros./bocc. patent				1
<i>Lever handle Q8 on rose-key escutcheon</i>	24,70	32,10	32,10	
Q8 RBY	55452285001	55452285003	55452285007	
Guarnitura Q8 ros./bocc. Yale				1
<i>Lever handle Q8 on rose-cyl escutcheon</i>	24,70	32,10	32,10	
Q8 RBWC	55452288001	55452288003	55452288007	
Guarnitura Q8 ros./bocc.Wc				1
<i>Lever handle Q8 on rose-WC function</i>	31,60	41,60	41,60	
Q8 ROC	55452220501	55452220503	55452220507	
Guarnitura Q8 ros.ovale senza bocc.				1
<i>Lever handle Q8 on oval rose</i>	24,70	31,80	31,80	
Q8 RBOC	55452221501	55452221503	55452221507	
Guarnitura Q8 ros/bocc.ovale patent				1
<i>Lever handle Q8 on oval rose-key escutcheon</i>	27,10	35,30	35,30	
Q8 RBOYC	55452225501	55452225503	55452225507	
Guarnitura Q8 ros/bocc.ovale Yale				1
<i>Lever handle Q8 on oval rose-cyl escutcheon</i>	27,10	35,30	35,30	



OLV-M1

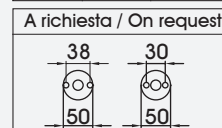
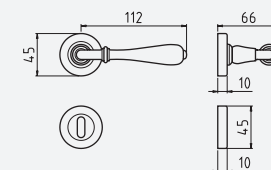
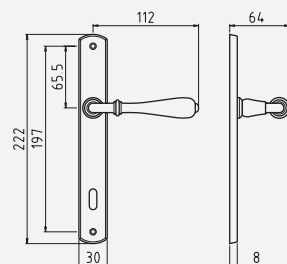
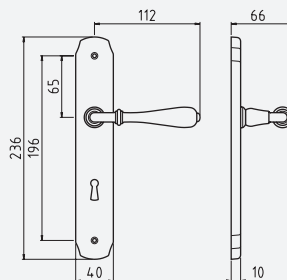

OBR-M45



OCL-M4



OLD-MV3



OFA-M69

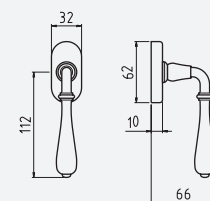
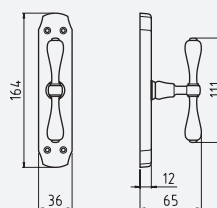
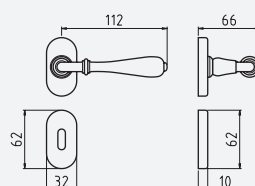
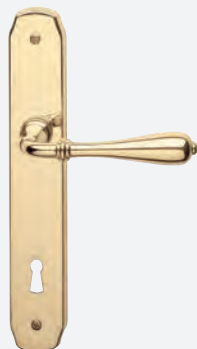

Per maggiori informazioni - For more information:

Rosette da pag. 246 a pag. 257
 Placche da pag. 265 a pag. 267
 DK da pag. 262 a pag. 264

Roses from pag. 246 to pag. 257
 Plates from pag. 265 to pag. 267
 Window handles from pag. 262 to pag. 264

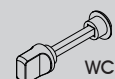

	OBR M45	OLV M1	OCL M4	OLD MV3	OFA M69	Conf. pz.
Q8 P90 Guarnitura Q8 placca patent 90 <i>Lever handle Q8 on key plate 90</i>	55196089000	55196089001	55196089007	55196089028	55196089029	1
	41,40	41,40	53,80	41,40	58,60	
Q8 P70 Guarnitura Q8 placca patent 70 <i>Lever handle Q8 on key plate 70</i>	55196087000	55196087001	55196087007	55196087028	55196087029	1
	41,40	41,40	53,80	41,40	58,60	
Q8 PY85 Guarnitura Q8 placca yale 85 <i>Lever handle Q8 on cyl. plate 85</i>	55196088500	55196088501	55196088507	55196088528	55196088529	1
	41,40	41,40	53,80	41,40	58,60	
Q8 P90RS Guarnitura Q8 placca stretta pat 90 <i>Lever handle Q8 on reduced key plate 90</i>	55196051000	55196051001	55196051007	55196051028	55196051029	1
	45,50	45,50	59,10	45,50	64,50	
Q8 P70RS Guarnitura Q8 placca stretta pat 70 <i>Lever handle Q8 on reduced key plate 70</i>	55196057000	55196057001	55196057007	55196057028	55196057029	1
	45,50	45,50	59,10	45,50	64,50	
Q8 PY85RS Guarnitura Q8 placca stretta yale85 <i>Lever handle Q8 on reduced cyl. plate 85</i>	55196055000	55196055001	55196055007	55196055028	55196055029	1
	45,50	45,50	59,10	45,50	64,50	
Q8 R Guarnitura Q8 ros. senza bocc. <i>Lever handle Q8 on rose</i>	55196280000	55196280001	55196280007	55196280028	55196280029	1
	34,40	34,40	44,70	34,40	48,70	
Q8 RB Guarnitura Q8 ros./bocc. patent <i>Lever handle Q8 on rose-key escutcheon</i>	55196281000	55196281001	55196281007	55196281028	55196281029	1
	39,60	39,60	51,60	39,60	56,20	
Q8 RBY Guarnitura Q8 ros./bocc. Yale <i>Lever handle Q8 on rose-cyl escutcheon</i>	55196285000	55196285001	55196285007	55196285028	55196285029	1
	39,60	39,60	51,60	39,60	56,20	
Q8 RBWC Guarnitura Q8 ros./bocc.Wc <i>Lever handle Q8 on rose-WC function</i>	55196288000	55196288001	55196288007	55196288028	55196288029	1
	46,50	46,50	62,50	46,50	65,90	
Q8 ROC Guarnitura Q8 ros.ovale senza bocc. <i>Lever handle Q8 on oval rose</i>	55196220500	55196220501	55196220507	55196220528	55196220529	1
	37,90	37,90	49,20	37,90	53,60	
Q8 RBOC Guarnitura Q8 ros/bocc.ovale patent <i>Lever handle Q8 on oval rose-key escutcheon</i>	55196221500	55196221501	55196221507	55196221528	55196221529	1
	43,60	43,60	56,70	43,60	61,80	
Q8 RBOYC Guarnitura Q8 ros/bocc.ovale Yale <i>Lever handle Q8 on oval rose-cyl escutcheon</i>	55196225500	55196225501	55196225507	55196225528	55196225529	1
	43,60	43,60	56,70	43,60	61,80	
MART Martellina Q7 <i>Window handle Q7</i>	55196500000	55196500001	55196500007	55196500028	55196500029	2
	23,20	23,20	30,10	23,20	32,90	
DK x 40-35 Martellina DK Q7 x 40-35 <i>Window handle Q7 DK-tilt & turn handle</i>	55196577000	55196577001	55196577007	55196577028	55196577029	2
	24,80	24,80	32,30	24,80	35,20	
DK x 40-35 C/BUSS. Martellina DK Q7 x 40-35 con bussole D. 9,5 <i>Window handle Q7 DK-tilt & turn handle with pins D. 9,5</i>	55196578000	55196578001	55196578007	55196578028	55196578029	2
	24,80	24,80	32,30	24,80	35,20	

Tutte le versioni cremonesi e martellina sono realizzabili applicando alla martellina i giochi disponibili a pag. 245

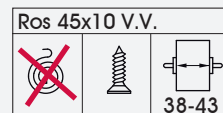
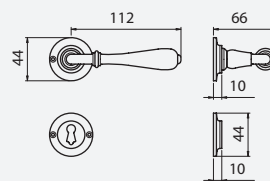

OFA-M69

Per maggiori informazioni - For more information:

	OBR M45	OLV M1	OCL M4	OLD MV3	OFA M69	Conf. pz.
Q8 RVV	55196250000	55196250001	55196250007	55196250028	55196250029	
Guarnitura Q8 ros. senza bocc.						1
<i>Lever handle Q8 on rose</i>	34,40	34,40	44,70	34,40	48,70	
Q8 RBVV	55196251000	55196251001	55196251007	55196251028	55196251029	
Guarnitura Q8 ros./bocc. patent						1
<i>Lever handle Q8 on rose-key escutcheon</i>	39,60	39,60	51,60	39,60	56,20	



OBR-M45

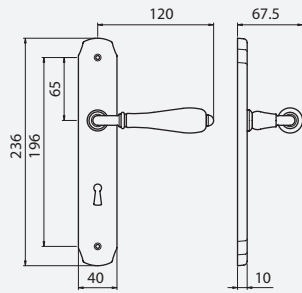

Placca NOVECENTO		
38-43		

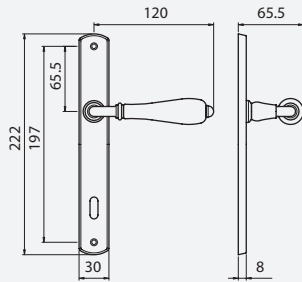

Placca STRETTA		
38-43		

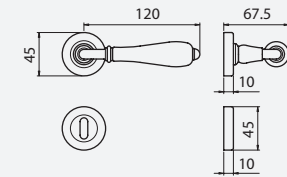

Ros 45x9 NOVECENTO		
38-43		

A richiesta / On request		
38	30	
50	50	



OLV-M1



OLD-MV3

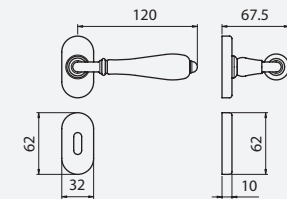

Ros 0006		
38-43		

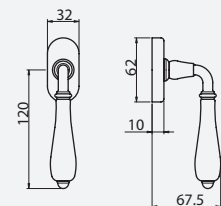
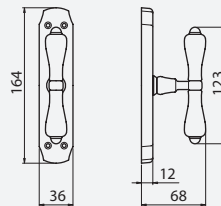

DK-1P

Per maggiori informazioni - For more information:

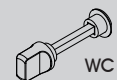

	OBR M45	OLV M1	OLD MV3	Conf. pz.
Q8 P90	55194089000	55194089001	55194089028	
Guarnitura Q8 placca patent 90				1
<i>Lever handle Q8 on key plate 90</i>	44,70	44,70	44,70	
Q8 P70	55194087000	55194087001	55194087028	
Guarnitura Q8 placca patent 70				1
<i>Lever handle Q8 on key plate 70</i>	44,70	44,70	44,70	
Q8 PY85	55194088500	55194088501	55194088528	
Guarnitura Q8 placca yale 85				1
<i>Lever handle Q8 on cyl. plate 85</i>	44,70	44,70	44,70	
Q8 P90RS	55194051000	55194051001	55194051028	
Guarnitura Q8 placca stretta pat 90				1
<i>Lever handle Q8 on reduced key plate 90</i>	49,20	49,20	49,20	
Q8 PY85RS	55194055000	55194055001	55194055028	
Guarnitura Q8 placca stretta yale85				1
<i>Lever handle Q8 on reduced cyl. plate 85</i>	49,20	49,20	49,20	
Q8 P70RS	55194057000	55194057001	55194057028	
Guarnitura Q8 placca stretta pat 70				1
<i>Lever handle Q8 on reduced key plate 70</i>	49,20	49,20	49,20	
Q8 R	55194280000	55194280001	55194280028	
Guarnitura Q8 ros. senza bocc.				1
<i>Lever handle Q8 on rose</i>	37,70	37,70	37,70	
Q8 RB	55194281000	55194281001	55194281028	
Guarnitura Q8 ros./bocc. patent				1
<i>Lever handle Q8 on rose-key escutcheon</i>	43,00	43,00	43,00	
Q8 RBY	55194285000	55194285001	55194285028	
Guarnitura Q8 ros./bocc. yale				1
<i>Lever handle Q8 on rose-cyl escutcheon</i>	43,00	43,00	43,00	
Q8 RBWC	55194288000	55194288001	55194288028	
Guarnitura Q8 ros./bocc.Wc				1
<i>Lever handle Q8 on rose-WC function</i>	49,90	49,90	49,90	
Q8 ROC	55194220500	55194220501	55194220528	
Guarnitura Q8 ros.ovale senza bocc.				1
<i>Lever handle Q8 on oval rose</i>	41,50	41,50	41,50	
Q8 RBOC	55194221500	55194221501	55194221528	
Guarnitura Q8 ros/bocc.ovale patent				1
<i>Lever handle Q8 on oval rose-key escutcheon</i>	47,30	47,30	47,30	
Q8 RBOYC	55194225500	55194225501	55194225528	
Guarnitura Q8 ros/bocc.ovale yale				1
<i>Lever handle Q8 on oval rose-cyl escutcheon</i>	47,30	47,30	47,30	
MART	55194500000	55194500001	55194500028	
Martellina Q7				2
<i>Window handle Q7</i>	26,60	26,60	26,60	
DK x 40	55194557000	55194557001	55194557028	
Martellina DK Q7 x 40				2
<i>Window handle Q7 DK-tilt & turn handle</i>	28,20	28,20	28,20	
DK x 40 C/BUSS.	55194558000	55194558001	55194558028	
Martellina DK Q7 x 40 con bussole D. 9,5				2
<i>Window handle Q7 DK-tilt & turn handle with pins d.9,5</i>	28,20	28,20	28,20	

Tutte le versioni cremonesi e martellina sono realizzabili applicando alla martellina i giochi disponibili a pag. 245

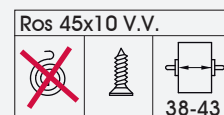
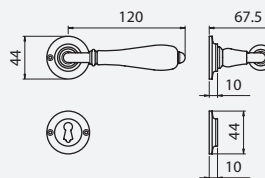

OLV-M1

Per maggiori informazioni - For more information:

	OBR M45	OLV M1	OLD MV3	Conf. pz.
Q8 RVV	55194250000	55194250001	55194250028	
Guarnitura Q8 ros. senza bocc.				1
<i>Lever handle Q8 on rose</i>	37,70	37,70	37,70	
Q8 RBVV	55194251000	55194251001	55194251028	
Guarnitura Q8 ros./bocc. patent				1
<i>Lever handle Q8 on rose-key escutcheon</i>	43,00	43,00	43,00	



OLV-M1

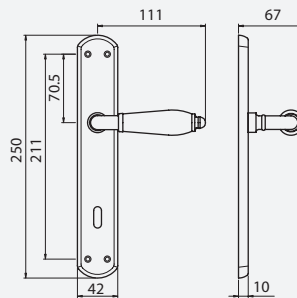

Placca MONICA 2		
38-43		

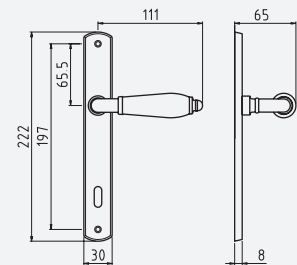

Placca STRETTA		
38-43		

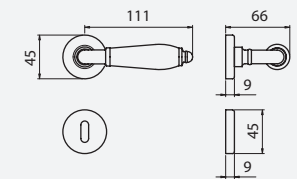

Ros 45x9		
38-43		

A richiesta / On request		
38	30	
50	50	

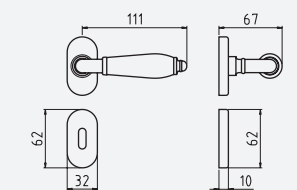

Ros 0006		
38-43		

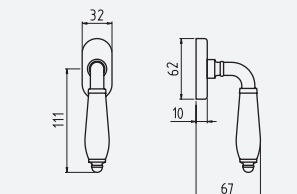
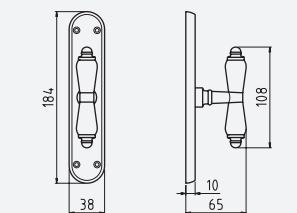

DK-1P

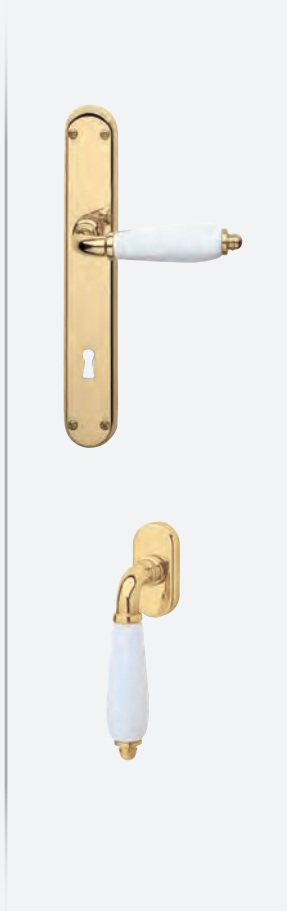

Per maggiori informazioni - For more information:



DISPONIBILE FINO AD ESAURIMENTO SCORTE

	OLV M1	Conf. pz.
Q8 P90 Guarnitura Q8 placca patent 90 <i>Lever handle Q8 on key plate 90</i>	55440089001 58,80	1
Q8 P70 Guarnitura Q8 placca patent 70 <i>Lever handle Q8 on key plate 70</i>	55440087001 58,80	1
Q8 PY85 Guarnitura Q8 placca yale 85 <i>Lever handle Q8 on cyl. plate 85</i>	55440088501 58,80	1
Q8 P90RS Guarnitura Q8 placca stretta pat 90 <i>Lever handle Q8 on reduced key plate 90</i>	55440051001 64,70	1
Q8 P70RS Guarnitura Q8 placca stretta pat 70 <i>Lever handle Q8 on reduced key plate 70</i>	55440057001 64,70	1
Q8 PY85RS Guarnitura Q8 placca stretta yale85 <i>Lever handle Q8 on reduced cyl. plate 85</i>	55440055001 64,70	1
Q8 R Guarnitura Q8 ros. senza bocc. <i>Lever handle Q8 on rose</i>	55440280001 53,00	1
Q8 RB Guarnitura Q8 ros./bocc. patent <i>Lever handle Q8 on rose-key escutcheon</i>	55440281001 57,10	1
Q8 RBY Guarnitura Q8 ros./bocc. Yale <i>Lever handle Q8 on rose-cyl escutcheon</i>	55440285001 57,10	1
Q8 RBWC Guarnitura Q8 ros./bocc.Wc <i>Lever handle Q8 on rose-WC function</i>	55440288001 63,90	1
Q8 ROC Guarnitura Q8 ros.ovale senza bocc. <i>Lever handle Q8 on oval rose</i>	55440220501 58,30	1
Q8 RBOC Guarnitura Q8 ros/bocc.ovale patent <i>Lever handle Q8 on oval rose-key escutcheon</i>	55440221501 62,80	1
Q8 RBOYC Guarnitura Q8 ros/bocc.ovale Yale <i>Lever handle Q8 on oval rose-cyl escutcheon</i>	55440225501 62,80	1
EZ Cremonese gioco EZ <i>Window handle Q7 with mechanism</i>	55440406001 40,30	2
EZQ7 Cremonese gioco EZ + Q7 <i>Window handle Q7 with mechanism</i>	55440407001 40,70	2
MART Martellina Q7 <i>Window handle Q7</i>	55440500001 39,60	2
DK x 40 Martellina DK Q7 x 40 <i>Window handle Q7 DK-tilt & turn handle</i>	55440557001 40,30	2

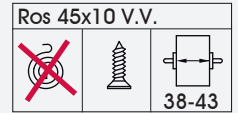
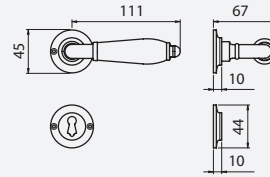

OLV-M1

Per maggiori informazioni - For more information:

DISPONIBILE FINO AD ESAURIMENTO SCORTE

	OLV M1	Conf. pz.
Q8 RVV		
Guarnitura Q8 ros. senza bocc.	55440250001	1
<i>Lever handle Q8 on rose</i>	53,00	
Q8 RBVV		
Guarnitura Q8 ros./bocc. patent	55440251001	1
<i>Lever handle Q8 on rose-key escutcheon</i>	57,10	



OLV-M1

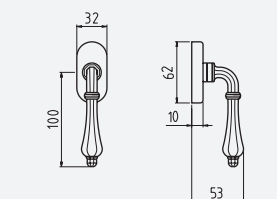
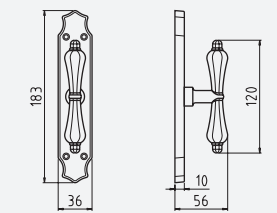
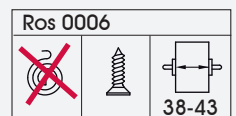
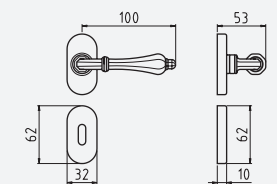
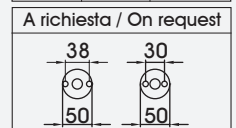
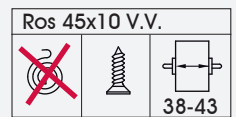
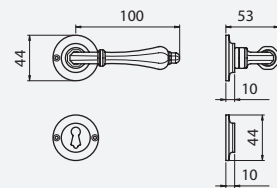
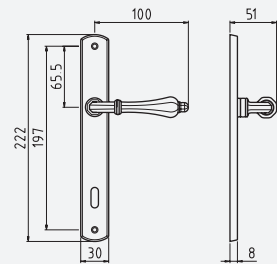
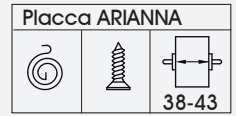
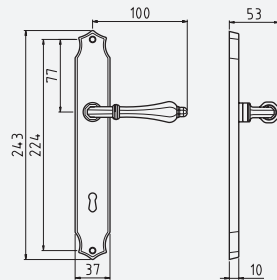

OF-M3



OLD-MV3



OFA-M69

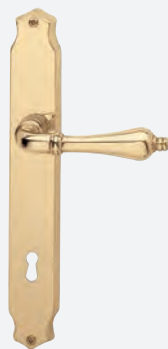

Per maggiori informazioni - For more information:

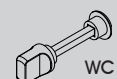

	OLV M1	OF M3	OLD MV3	OFA M69	Conf. pz.
Q8 P90 Guarnitura Q8 placca patent 90 <i>Lever handle Q8 on key plate 90</i>	55640089001	55640089006	55640089028	55640089029	1
	42,40	42,40	42,40	59,00	
Q8 P70 Guarnitura Q8 placca patent 70 <i>Lever handle Q8 on key plate 70</i>	55640087001	55640087006	55640087028	55640087029	1
	42,40	42,40	42,40	59,00	
Q8 PY85 Guarnitura Q8 placca yale 85 <i>Lever handle Q8 on cyl. plate 85</i>	55640088501	55640088506	55640088528	55640088529	1
	42,40	42,40	42,40	59,00	
Q8 P90RS Guarnitura Q8 placca stretta pat 90 <i>Lever handle Q8 on reduced key plate 90</i>	55640051001	55640051006	55640051028	55640051029	1
	46,60	46,60	46,60	64,90	
Q8 P70RS Guarnitura Q8 placca stretta pat 70 <i>Lever handle Q8 on reduced key plate 70</i>	55640057001	55640057006	55640057028	55640057029	1
	46,60	46,60	46,60	64,90	
Q8 PY85RS Guarnitura Q8 placca stretta yale85 <i>Lever handle Q8 on reduced cyl. plate 85</i>	55640055001	55640055006	55640055028	55640055029	1
	46,60	46,60	46,60	64,90	
Q8 RVV Guarnitura Q8 ros. senza bocc. <i>Lever handle Q8 on rose</i>	55640250001	55640250006	55640250028	55640250029	1
	33,30	33,30	33,30	47,10	
Q8 RBVV Guarnitura Q8 ros./bocc. patent <i>Lever handle Q8 on rose-key escutcheon</i>	55640251001	55640251006	55640251028	55640251029	1
	40,70	40,70	40,70	57,60	
Q8 RBYVV Guarnitura Q8 ros./bocc. Yale <i>Lever handle Q8 on rose-cyl escutcheon</i>	55640255001	55640255006	55640255028	55640255029	1
	40,70	40,70	40,70	57,60	
Q8 ROC Guarnitura Q8 ros.ovale senza bocc. <i>Lever handle Q8 on oval rose</i>	55640220501	55640220506	55640220528	55640220529	1
	36,60	36,60	36,60	51,90	
Q8 RBOC Guarnitura Q8 ros./bocc.ovale patent <i>Lever handle Q8 on oval rose-key escutcheon</i>	55640221501	55640221506	55640221528	55640221529	1
	44,70	44,70	44,70	63,40	
Q8 RBOYC Guarnitura Q8 ros./bocc.ovale Yale <i>Lever handle Q8 on oval rose-cyl escutcheon</i>	55640225501	55640225506	55640225528	55640225529	1
	44,70	44,70	44,70	63,40	
EZ Cremonese gioco EZ <i>Window handle Q7 with mechanism</i>	55640406001	55640406006	55640406028	55640406029	2
	26,00	26,00	26,00	37,70	
EZQ7 Cremonese gioco EZ + Q7 <i>Window handle Q7 with mechanism</i>	55640407001	55640407006	55640407028	55640407029	2
	26,40	26,40	26,40	38,10	
MART Martellina Q7 <i>Window handle Q7</i>	55640500001	55640500006	55640500028	55640500029	2
	25,30	25,30	25,30	36,60	
DK x 40 Martellina DK Q7 x 40 <i>Window handle Q7 DK-tilt & turn handle</i>	55640557001	55640557006	55640557028	55640557029	2
	26,00	26,00	26,00	37,70	

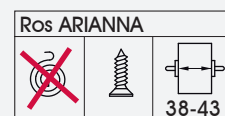
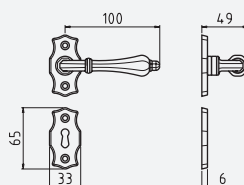

OLD-MV3

Per maggiori informazioni - For more information:

ARIANNA

	OLV M1	OF M3	OLD MV3	OFA M69	Conf. pz.
Q8 R Guarnitura Q8 ros. senza bocc. <i>Lever handle Q8 on rose</i>	55640280001	55640280006	55640280028	55640280029	1
	33,30	33,30	33,30	47,10	
Q8 RB Guarnitura Q8 ros./bocc. patent <i>Lever handle Q8 on rose-key escutcheon</i>	55640281001	55640281006	55640281028	55640281029	1
	40,70	40,70	40,70	57,60	
Q8 RBY Guarnitura Q8 ros./bocc. Yale <i>Lever handle Q8 on rose-cyl escutcheon</i>	55640285001	55640285006	55640285028	55640285029	1
	40,70	40,70	40,70	57,60	

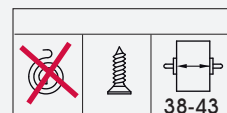
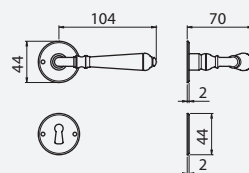
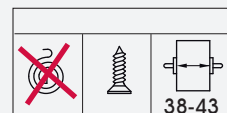
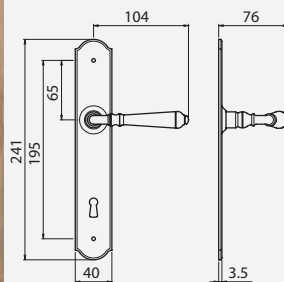

FA

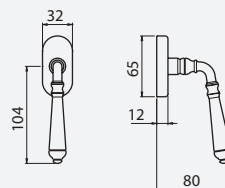

FA

	FA	Conf. pz.
Q8 P90		
Guarnitura Q8 placca patent 90	33600089011	1
<i>Lever handle Q8 on key plate 90</i>	70,20	
Q8 P70		
Guarnitura Q8 placca patent 70	33600087011	1
<i>Lever handle Q8 on key plate 70</i>	70,20	
Q8 PY85		
Guarnitura Q8 placca yale 85	33600088511	1
<i>Lever handle Q8 on cyl. plate 85</i>	70,20	
<hr/>		
Q8 R		
Guarnitura Q8 ros. senza bocchetta	33600250011	1
<i>Lever handle Q8 on rose</i>	54,50	
Q8 RB		
Guarnitura Q8 ros./bocc. patent	33600251011	1
<i>Lever handle Q8 on rose-key escutcheon</i>	63,30	
Q8 RBY		
Guarnitura Q8 ros./bocc. Yale	33600255011	1
<i>Lever handle Q8 on rose-cyl escutcheon</i>	63,30	
<hr/>		
MART		
Martellina Q7	33600500011	2
<i>Window handle Q7</i>	41,60	
DKx40 gioco in ferro		
Martellina DK Q7x40	33600549011	2
<i>Window handle Q7 DK-tilt turn handle</i>	40,40	



OGV-M27

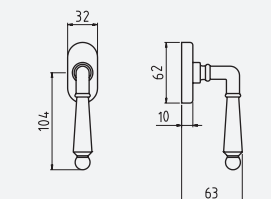
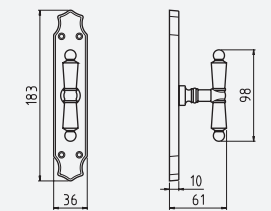
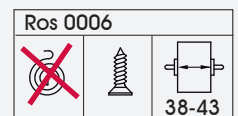
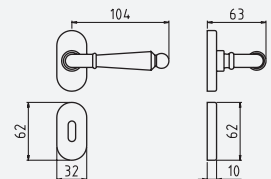
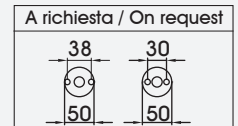
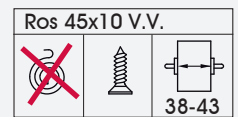
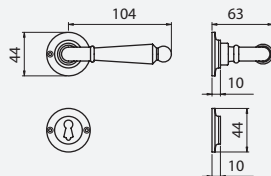
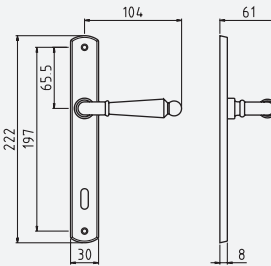
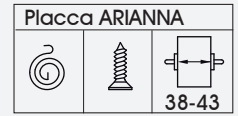
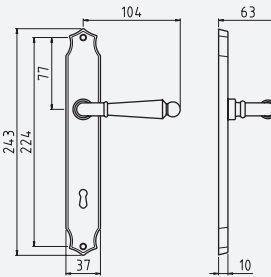

OLV-M1



OF-M3



OCL-M4

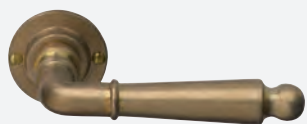

OLD-MV3



Per maggiori informazioni - For more information:



	OLV M1	OGV M27	OF M3	OCL M4	OLD MV3	Conf. pz.
Q8 P90 Guarnitura Q8 placca patent 90 <i>Lever handle Q8 on key plate 90</i>	55644089001	55644089004	55644089006	55644089007	55644089028	1
	41,40	41,40	41,40	53,80	41,40	
Q8 P70 Guarnitura Q8 placca patent 70 <i>Lever handle Q8 on key plate 70</i>	55644087001	55644087004	55644087006	55644087007	55644087028	1
	41,40	41,40	41,40	53,80	41,40	
Q8 PY85 Guarnitura Q8 placca yale 85 <i>Lever handle Q8 on cyl. plate 85</i>	55644088501	55644088504	55644088506	55644088507	55644088528	1
	41,40	41,40	41,40	53,80	41,40	
Q8 P90RS Guarnitura Q8 placca stretta pat 90 <i>Lever handle Q8 on reduced key plate 90</i>	55644051001	55644051004	55644051006	55644051007	55644051028	1
	45,50	45,50	45,50	59,20	45,50	
Q8 P70RS Guarnitura Q8 placca stretta pat 70 <i>Lever handle Q8 on reduced key plate 70</i>	55644057001	55644057004	55644057006	55644057007	55644057028	1
	45,50	45,50	45,50	59,20	45,50	
Q8 PY85RS Guarnitura Q8 placca stretta yale85 <i>Lever handle Q8 on reduced cyl. plate 85</i>	55644055001	55644055004	55644055006	55644055007	55644055028	1
	45,50	45,50	45,50	59,20	45,50	
Q8 RVV Guarnitura Q8 ros. senza bocc. <i>Lever handle Q8 on rose</i>	55644250001	55644250004	55644250006	55644250007	55644250028	1
	32,30	32,30	32,30	41,90	32,30	
Q8 RBVV Guarnitura Q8 ros./bocc. patent <i>Lever handle Q8 on rose-key escutcheon</i>	55644251001	55644251004	55644251006	55644251007	55644251028	1
	39,60	39,60	39,60	51,60	39,60	
Q8 RBYVV Guarnitura Q8 ros./bocc. Yale <i>Lever handle Q8 on rose-cyl escutcheon</i>	55644255001	55644255004	55644255006	55644255007	55644255028	1
	39,60	39,60	39,60	51,60	39,60	
Q8 ROC Guarnitura Q8 ros.ovale senza bocc. <i>Lever handle Q8 on oval rose</i>	55644220501	55644220504	55644220506	55644220507	55644220528	1
	35,50	35,50	35,50	46,10	35,50	
Q8 RBOC Guarnitura Q8 ros./bocc.ovale patent <i>Lever handle Q8 on oval rose-key escutcheon</i>	55644221501	55644221504	55644221506	55644221507	55644221528	1
	43,60	43,60	43,60	56,70	43,60	
Q8 RBOYC Guarnitura Q8 ros./bocc.ovale Yale <i>Lever handle Q8 on oval rose-cyl escutcheon</i>	55644225501	55644225504	55644225506	55644225507	55644225528	1
	43,60	43,60	43,60	56,70	43,60	
EZ Cremonese gioco EZ <i>Window handle Q7 with mechanism</i>	55644406001	55644406004	55644406006	55644406007	55644406028	2
	23,30	23,30	23,30	30,20	23,30	
EZQ7 Cremonese gioco EZ + Q7 <i>Window handle Q7 with mechanism</i>	55644407001	55644407004	55644407006	55644407007	55644407028	2
	23,70	23,70	23,70	30,70	23,70	
MART Martellina Q7 <i>Window handle Q7</i>	55644500001	55644500004	55644500006	55644500007	55644500028	2
	22,60	22,60	22,60	29,30	22,60	
DK x 40 Martellina DK Q7 x 40 <i>Window handle Q7 DK-tilt & turn handle</i>	55644557001	55644557004	55644557006	55644557007	55644557028	2
	23,30	23,30	23,30	30,20	23,30	

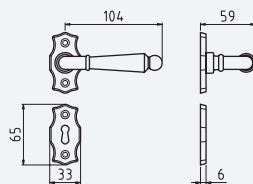

Ros ARIANNA		
38-43		

OLV-M1

Per maggiori informazioni - For more information:

PERLA

	OLV M1	OGV M27	OF M3	OCL M4	OLD MV3	Conf. pz.
Q8 R	55644280001	55644280004	55644280006	55644280007	55644280028	
Guarnitura Q8 ros. senza bocc.						1
<i>Lever handle Q8 on rose</i>	32,30	32,30	32,30	41,90	32,30	
Q8 RB	55644281001	55644281004	55644281006	55644281007	55644281028	
Guarnitura Q8 ros./bocc. patent						1
<i>Lever handle Q8 on rose-key escutcheon</i>	39,60	39,60	39,60	51,60	39,60	
Q8 RBY	55644285001	55644285004	55644285006	55644285007	55644285028	
Guarnitura Q8 ros./bocc. Yale						1
<i>Lever handle Q8 on rose-cyl escutcheon</i>	39,60	39,60	39,60	51,60	39,60	



OLV-M1

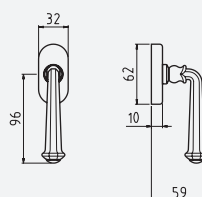
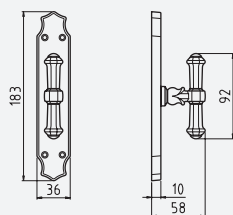
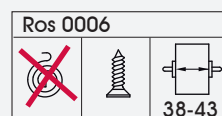
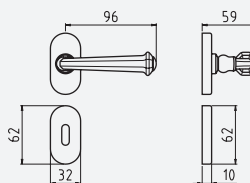
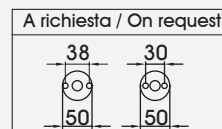
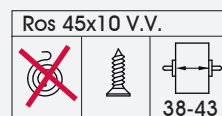
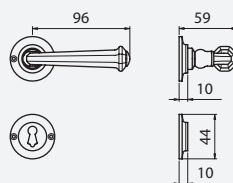
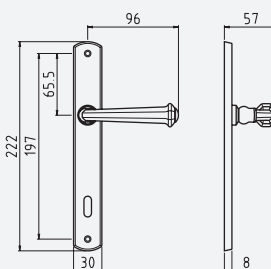
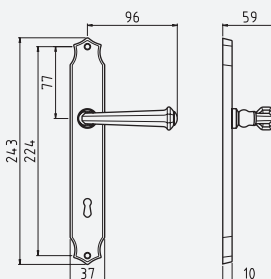

OGV-M27



OLD-MV3



Per maggiori informazioni - For more information:

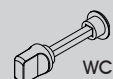

	OLV M1	OGV M27	OLD MV3	Conf. pz.
Q8 P90	55642089001	55642089004	55642089028	
Guarnitura Q8 placca patent 90				1
<i>Lever handle Q8 on key plate 90</i>	42,40	42,40	42,40	
Q8 P70	55642087001	55642087004	55642087028	
Guarnitura Q8 placca patent 70				1
<i>Lever handle Q8 on key plate 70</i>	42,40	42,40	42,40	
Q8 PY85	55642088501	55642088504	55642088528	
Guarnitura Q8 placca yale 85				1
<i>Lever handle Q8 on cyl. plate 85</i>	42,40	42,40	42,40	
Q8 P90RS	55642051001	55642051004	55642051028	
Guarnitura Q8 placca stretta pat 90				1
<i>Lever handle Q8 on reduced key plate 90</i>	46,60	46,60	46,60	
Q8 P70RS	55642057001	55642057004	55642057028	
Guarnitura Q8 placca stretta pat 70				1
<i>Lever handle Q8 on reduced key plate 70</i>	46,60	46,60	46,60	
Q8 PY85RS	55642055001	55642055004	55642055028	
Guarnitura Q8 placca stretta yale85				1
<i>Lever handle Q8 on reduced cyl. plate 85</i>	46,60	46,60	46,60	
Q8 RVV	55642250001	55642250004	55642250028	
Guarnitura Q8 ros. senza bocc.				1
<i>Lever handle Q8 on rose</i>	33,30	33,30	33,30	
Q8 RBVV	55642251001	55642251004	55642251028	
Guarnitura Q8 ros./bocc. patent				1
<i>Lever handle Q8 on rose-key escutcheon</i>	40,70	40,70	40,70	
Q8 RBVYV	55642255001	55642255004	55642255028	
Guarnitura Q8 ros./bocc. Yale				1
<i>Lever handle Q8 on rose-cyl escutcheon</i>	40,70	40,70	40,70	
Q8 ROC	55642220501	55642220504	55642220528	
Guarnitura Q8 ros.ovale senza bocc.				1
<i>Lever handle Q8 on oval rose</i>	36,60	36,60	36,60	
Q8 RBOC	55642221501	55642221504	55642221528	
Guarnitura Q8 ros/bocc.ovale patent				1
<i>Lever handle Q8 on oval rose-key escutcheon</i>	44,70	44,70	44,70	
Q8 RBOYC	55642225501	55642225504	55642225528	
Guarnitura Q8 ros/bocc.ovale Yale				1
<i>Lever handle Q8 on oval rose-cyl escutcheon</i>	44,70	44,70	44,70	
EZ	55642406001	55642406004	55642406028	
Cremonese gioco EZ				2
<i>Window handle Q7 with mechanism</i>	26,00	26,00	26,00	
EZQ7	55642407001	55642407004	55642407028	
Cremonese gioco EZ + Q7				2
<i>Window handle Q7 with mechanism</i>	26,40	26,40	26,40	
MART	55642500001	55642500004	55642500028	
Martellina Q7				2
<i>Window handle Q7</i>	25,30	25,30	25,30	
DK x 40	55642557001	55642557004	55642557028	
Martellina DK Q7 x 40				2
<i>Window handle Q7 DK-tilt & turn handle</i>	26,00	26,00	26,00	

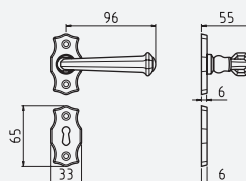

Ros ARIANNA		
38-43		

OF-M3

Per maggiori informazioni - For more information:

	OLV M1	OGV M27	OLD MV3	Conf. pz.
Q8 R	55642280001	55642280004	55642280028	
Guarnitura Q8 ros. senza bocc.	33,30	33,30	33,30	1
<i>Lever handle Q8 on rose</i>				
Q8 RB	55642281001	55642281004	55642281028	
Guarnitura Q8 ros./bocc. patent	40,70	40,70	40,70	1
<i>Lever handle Q8 on rose-key escutcheon</i>				
Q8 RBY	55642285001	55642285004	55642285028	
Guarnitura Q8 ros./bocc. Yale	40,70	40,70	40,70	1
<i>Lever handle Q8 on rose-cyl escutcheon</i>				



OLV-M1

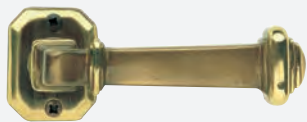
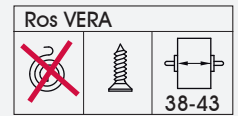
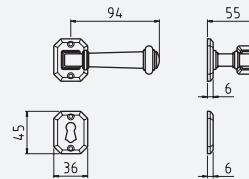
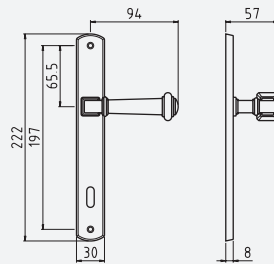
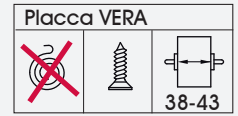
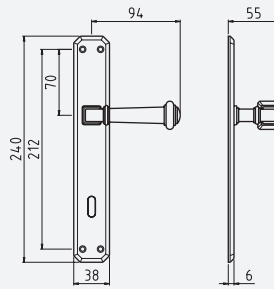

OGV-M27

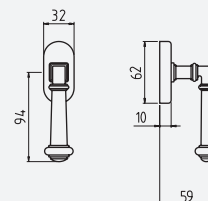
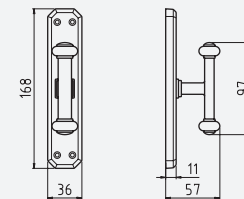
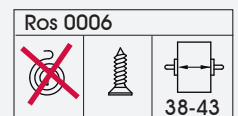
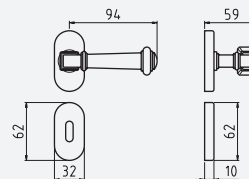

Per maggiori informazioni - For more information:

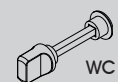

	OLV M1	OGV M27	Conf. pz.
Q8 P90 Guarnitura Q8 placca patent 90 <i>Lever handle Q8 on key plate 90</i>	55596089001 57,40	55596089004 57,40	1
Q8 P70 Guarnitura Q8 placca patent 70 <i>Lever handle Q8 on key plate 70</i>	55596087001 57,40	55596087004 57,40	1
Q8 PY85 Guarnitura Q8 placca yale 85 <i>Lever handle Q8 on cyl. plate 85</i>	55596088501 57,40	55596088504 57,40	1
Q8 P90RS Guarnitura Q8 placca stretta pat 90 <i>Lever handle Q8 on reduced key plate 90</i>	55596051001 63,20	55596051004 63,20	1
Q8 P70RS Guarnitura Q8 placca stretta pat 70 <i>Lever handle Q8 on reduced key plate 70</i>	55596057001 63,20	55596057004 63,20	1
Q8 PY85RS Guarnitura Q8 placca stretta yale85 <i>Lever handle Q8 on reduced cyl. plate 85</i>	55596055001 63,20	55596055004 63,20	1
Q8 R Guarnitura Q8 ros. senza bocc. <i>Lever handle Q8 on rose</i>	55596280001 47,90	55596280004 47,90	1
Q8 RB Guarnitura Q8 ros./bocc. patent <i>Lever handle Q8 on rose-key escutcheon</i>	55596281001 55,70	55596281004 55,70	1
Q8 RBY Guarnitura Q8 ros./bocc. Yale <i>Lever handle Q8 on rose-cyl escutcheon</i>	55596285001 55,70	55596285004 55,70	1
Q8 ROC Guarnitura Q8 ros.ovale senza bocc. <i>Lever handle Q8 on oval rose</i>	55596220501 52,70	55596220504 52,70	1
Q8 RBOC Guarnitura Q8 ros/bocc.ovale patent <i>Lever handle Q8 on oval rose-key escutcheon</i>	55596221501 61,30	55596221504 61,30	1
Q8 RBOYC Guarnitura Q8 ros/bocc.ovale Yale <i>Lever handle Q8 on oval rose-cyl escutcheon</i>	55596225501 61,30	55596225504 61,30	1
EZ Cremonese gioco EZ <i>Window handle Q7 with mechanism</i>	55596406001 37,60	55596406004 37,60	2
EZQ7 Cremonese gioco EZ + Q7 <i>Window handle Q7 with mechanism</i>	55596407001 38,00	55596407004 38,00	2
MART Martellina Q7 <i>Window handle Q7</i>	55596500001 36,90	55596500004 36,90	2
DK x 40 Martellina DK Q7 x 40 <i>Window handle Q7 DK-tilt & turn handle</i>	55596557001 37,60	55596557004 37,60	2



OFA-M69

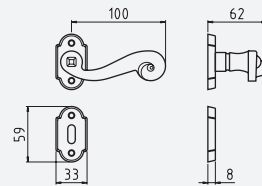

Ros CHIARA		
		38-43

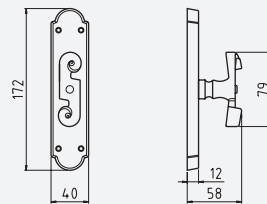

OLD-MV3

Per maggiori informazioni - For more information:

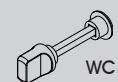

	OLD MV3	OFA M69	Conf. pz.
Q8 R	55896280028	55896280029	
Guarnitura Q8 ros. senza bocc.			1
<i>Lever handle Q8 on rose</i>	69,80	86,40	
Q8 RB	55896281028	55896281029	
Guarnitura Q8 ros./bocc. patent			1
<i>Lever handle Q8 on rose-key escutcheon</i>	87,90	104,50	
Q8 RBY	55896285028	55896285029	
Guarnitura Q8 ros./bocc. Yale			1
<i>Lever handle Q8 on rose-cyl escutcheon</i>	87,90	104,50	
EZ	55896406028	55896406029	
Cremonese gioco EZ			1
<i>Window handle Q7 with mechanism</i>	56,40	65,70	
EZQ7	55896407028	55896407029	
Cremonese gioco EZ + Q7			1
<i>Window handle Q7 with mechanism</i>	56,80	66,10	
MART	55896500028	55896500029	
Martellina Q7			1
<i>Window handle Q7</i>	56,10	65,70	



OLV-M1

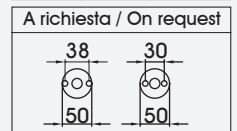
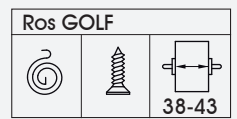
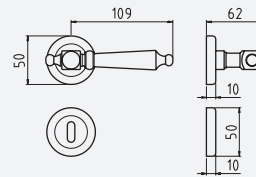
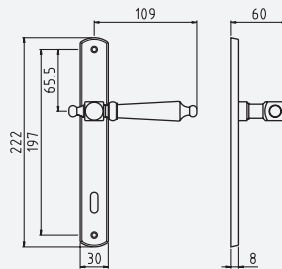
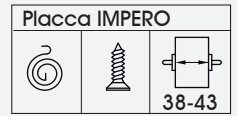
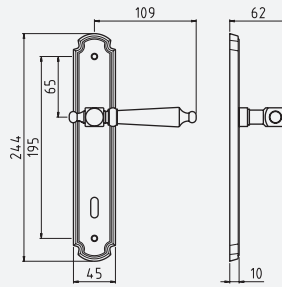

OGV-M27



OLD-MV3

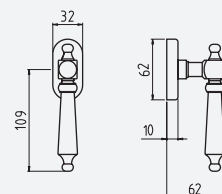
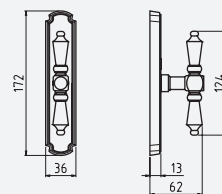
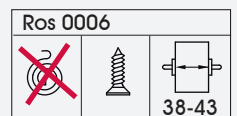
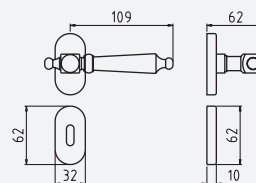

Per maggiori informazioni - For more information:



	OLV M1	OGV M27	OLD MV3	Conf. pz.
Q8 P90	55418089001	55418089004	55418089028	
Guarnitura Q8 placca patent 90				1
<i>Lever handle Q8 on key plate 90</i>	68,40	68,40	68,40	
Q8 P70	55418087001	55418087004	55418087028	
Guarnitura Q8 placca patent 70				1
<i>Lever handle Q8 on key plate 70</i>	68,40	68,40	68,40	
Q8 PY85	55418088501	55418088504	55418088528	
Guarnitura Q8 placca yale 85				1
<i>Lever handle Q8 on cyl. plate 85</i>	68,40	68,40	68,40	
Q8 P90RS	55418051001	55418051004	55418051028	
Guarnitura Q8 placca stretta pat 90				1
<i>Lever handle Q8 on reduced key plate 90</i>	75,20	75,20	75,20	
Q8 P70RS	55418057001	55418057004	55418057028	
Guarnitura Q8 placca stretta pat 70				1
<i>Lever handle Q8 on reduced key plate 70</i>	75,20	75,20	75,20	
Q8 PY85RS	55418055001	55418055004	55418055028	
Guarnitura Q8 placca stretta yale85				1
<i>Lever handle Q8 on reduced cyl. plate 85</i>	75,20	75,20	75,20	
Q8 R	55418280001	55418280004	55418280028	
Guarnitura Q8 ros. senza bocc.				1
<i>Lever handle Q8 on rose</i>	52,00	52,00	52,00	
Q8 RB	55418281001	55418281004	55418281028	
Guarnitura Q8 ros./bocc. patent				1
<i>Lever handle Q8 on rose-key escutcheon</i>	68,40	68,40	68,40	
Q8 RBY	55418285001	55418285004	55418285028	
Guarnitura Q8 ros./bocc. Yale				1
<i>Lever handle Q8 on rose-cyl escutcheon</i>	68,40	68,40	68,40	
Q8 RBWC	55418288001	55418288004	55418288028	
Guarnitura Q8 ros./bocc.Wc				1
<i>Lever handle Q8 on rose-WC function</i>	75,20	75,20	75,20	
Q8 ROC	55418220501	55418220504	55418220528	
Guarnitura Q8 ros.ovale senza bocc.				1
<i>Lever handle Q8 on oval rose</i>	57,20	57,20	57,20	
Q8 RBOC	55418221501	55418221504	55418221528	
Guarnitura Q8 ros/bocc.ovale patent				1
<i>Lever handle Q8 on oval rose-key escutcheon</i>	75,20	75,20	75,20	
Q8 RBOYC	55418225501	55418225504	55418225528	
Guarnitura Q8 ros/bocc.ovale Yale				1
<i>Lever handle Q8 on oval rose-cyl escutcheon</i>	75,20	75,20	75,20	
EZ	55418406001	55418406004	55418406028	
Cremonese gioco EZ				2
<i>Window handle Q7 with mechanism</i>	47,80	47,80	47,80	
EZQ7	55418407001	55418407004	55418407028	
Cremonese gioco EZ + Q7				2
<i>Window handle Q7 with mechanism</i>	48,20	48,20	48,20	
MART	55418500001	55418500004	55418500028	
Martellina Q7				2
<i>Window handle Q7</i>	47,80	47,80	47,80	
DK x 40	55418557001	55418557004	55418557028	
Martellina DK Q7 x 40				2
<i>Window handle Q7 DK-tilt & turn handle</i>	47,80	47,80	47,80	

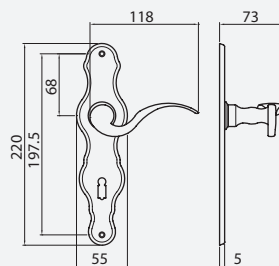

OLV-M1

	OLV M1	OF M3	Conf. pz.
11/21 Q8 BB72 VL Guarnitura Q8 placca BB 72 con viti legno <i>Lever handle Q8 on key plate 72 with wood screw</i>	R001100217301 26,90	R001100217306 26,90	1
11/21 Q8 PZ72 VL Guarnitura Q8 placca Yale 72 con viti legno <i>Lever handle Q8 on cyl. plate 72 with wood screw</i>	R001100217701 26,90	R001100217706 26,90	1
11/21 Q8 WC78 Q8 VL Guarnitura Q8 placca WC 78 Q8 viti legno <i>Lever handle Q8 on WC Q8 function plate 78 with wood screw</i>	R001100219801 34,50	R001100219806 34,50	1

R11/23



OLV-M1

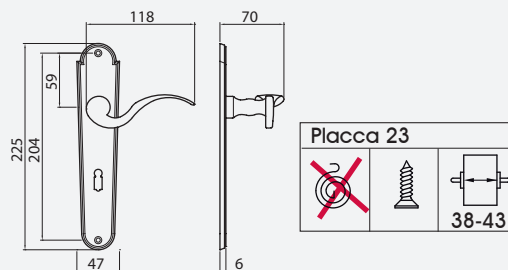

11/23 Q8 BB72 VL

Guarnitura Q8 placca BB 72 con viti legno

Lever handle Q8 on key plate 72 with wood screw

11/23 Q8 PZ72 VL

Guarnitura Q8 placca Yale 72 con viti legno

Lever handle Q8 on cyl. plate 72 with wood screw

11/23 Q8 WC78 Q8 VL

Guarnitura Q8 placca WC 78 Q8 viti legno

Lever handle Q8 on WC Q8 function plate 78 with wood screw

	OLV M1	OF M3	Conf. pz.
	R001100237301	R001100237306	1
	26,90	26,90	
	R001100237701	R001100237706	1
	26,90	26,90	
	R001100239801	R001100239806	1
	34,50	34,50	



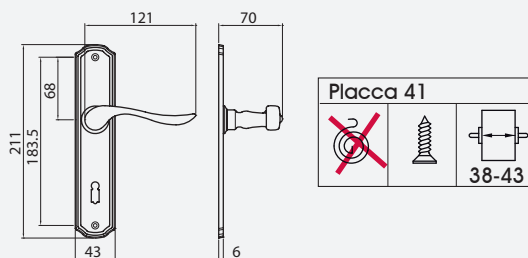

OLV-M1

	OLV M1	Conf. pz.
31/41 Q8 BB72 VL Guarnitura Q8 placca BB 72 con viti legno <i>Lever handle Q8 on key plate 72 with wood screw</i>	R003100417301 54,40	1
31/41 Q8 PZ72 VL Guarnitura Q8 placca Yale 72 con viti legno <i>Lever handle Q8 on cyl. plate 72 with wood screw</i>	R003100417701 54,40	1
31/41 Q8 WC78 Q8 VL Guarnitura Q8 placca WC 78 Q8 viti legno <i>Lever handle Q8 on WC Q8 function plate 78 with wood screw</i>	R003100419801 65,00	1

R54/45



OLV-M1

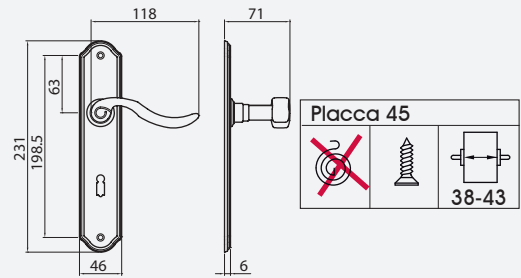

54/45 Q8 BB72 VL

Guarnitura Q8 placca BB 72 con viti legno

Lever handle Q8 on key plate 72 with wood screw

54/45 Q8 PZ72 VL

Guarnitura Q8 placca Yale 72 con viti legno

Lever handle Q8 on cyl. plate 72 with wood screw

54/45 Q8 WC78 Q8 VL

Guarnitura Q8 placca WC 78 Q8 viti legno

Lever handle Q8 on WC Q8 function plate 78 with wood screw

	OLV M1	Conf. pz.
	R005400457301	1
	41,80	
	R005400457701	1
	41,80	
	R005400459801	1
	52,40	





OGV-M27

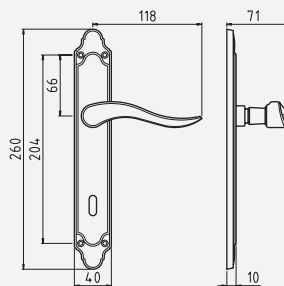

Placca MAYA		
38-43		

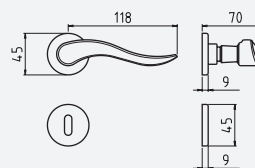

Ros 45x9		
38-43		

A richiesta / On request		

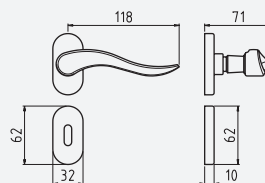

Ros 0006		
38-43		

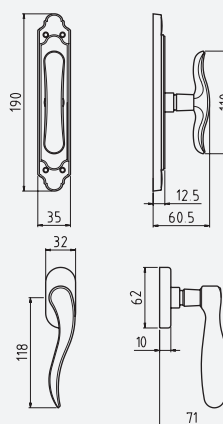

DK-1P

Per maggiori informazioni - For more information:

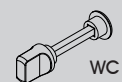

	OGV M27	Conf. pz.
Q8 P90 Guarnitura Q8 placca patent 90 <i>Lever handle Q8 on key plate 90</i>	55546089004 41,00	1
Q8 P70 Guarnitura Q8 placca patent 70 <i>Lever handle Q8 on key plate 70</i>	55546087004 41,00	1
Q8 PY85 Guarnitura Q8 placca yale 85 <i>Lever handle Q8 on cyl. plate 85</i>	55546088504 41,00	1
Q8 R Guarnitura Q8 ros. senza bocc. <i>Lever handle Q8 on rose</i>	55546280004 35,20	1
Q8 RB Guarnitura Q8 ros./bocc. patent <i>Lever handle Q8 on rose-key escutcheon</i>	55546281004 39,30	1
Q8 RBY Guarnitura Q8 ros./bocc. Yale <i>Lever handle Q8 on rose-cyl escutcheon</i>	55546285004 39,30	1
Q8 RBWC Guarnitura Q8 ros./bocc.Wc <i>Lever handle Q8 on rose-WC function</i>	55546288004 46,10	1
Q8 ROC Guarnitura Q8 ros.ovale senza bocc. <i>Lever handle Q8 on oval rose</i>	55546220504 38,70	1
Q8 RBOC Guarnitura Q8 ros/bocc.ovale patent <i>Lever handle Q8 on oval rose-key escutcheon</i>	55546221504 43,30	1
Q8 RBOYC Guarnitura Q8 ros/bocc.ovale Yale <i>Lever handle Q8 on oval rose-cyl escutcheon</i>	55546225504 43,30	1
EZ Cremonese gioco EZ <i>Window handle Q7 with mechanism</i>	55546406004 22,60	2
EZQ7 Cremonese gioco EZ + Q7 <i>Window handle Q7 with mechanism</i>	55546407004 23,00	2
MART Martellina Q7 <i>Window handle Q7</i>	55546500004 21,90	2
DK x 40 Martellina DK Q7 x 40 <i>Window handle Q7 DK-tilt & turn handle</i>	55546557004 22,60	2



OF-M3

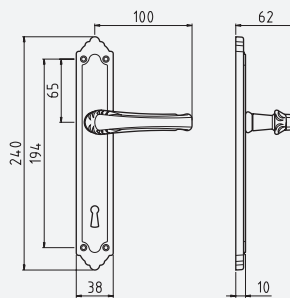

Placca LADY		
38-43		

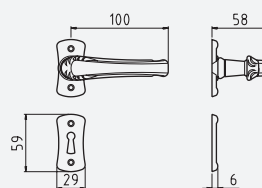

Ros LADY		
38-43		

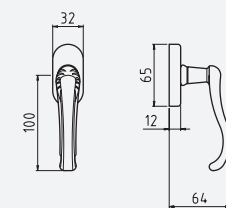
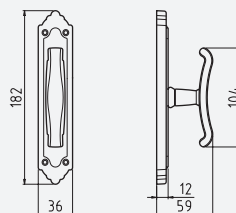

DK-1P

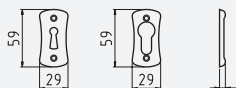

	OF M3	Conf. pz.
Q8 P90 Guarnitura Q8 placca patent 90 <i>Lever handle Q8 on key plate 90</i>	44394089006 22,10	4
Q8 P70 Guarnitura Q8 placca patent 70 <i>Lever handle Q8 on key plate 70</i>	44394087006 22,10	4
Q8 PY85 Guarnitura Q8 placca yale 85 <i>Lever handle Q8 on cyl. plate 85</i>	44394088506 22,10	4
Q8 R Guarnitura Q8 ros. senza bocc. <i>Lever handle Q8 on rose</i>	44394280006 12,60	4
Q8 RB Guarnitura Q8 ros./bocc. patent <i>Lever handle Q8 on rose-key escutcheon</i>	44394281006 20,40	4
Q8 RBY Guarnitura Q8 ros./bocc. Yale <i>Lever handle Q8 on rose-cyl escutcheon</i>	44394285006 20,40	4
GZ Cremonese gioco GZ <i>Window handle Q7 with mechanism</i>	44394401006 14,40	6
GZP Cremonese gioco GZ + PERNI <i>Window handle Q7 with mechanism</i>	44394402006 14,90	6
GZQ7 Cremonese gioco GZ + Q7 <i>Window handle Q7 with mechanism</i>	44394403006 14,90	6
MART Martellina Q7 <i>Window handle Q7</i>	44394500006 13,80	6
DK x 40 Martellina DK Q7 x 40 <i>Window handle Q7 DK-tilt & turn handle</i>	44394555006 14,40	2
BOC PAT Bocchetta patent <i>Key escutcheon</i>	44398601006 3,90	-
BOC YALE Bocchetta yale <i>Cyl. key escutcheon</i>	44398605006 3,90	-

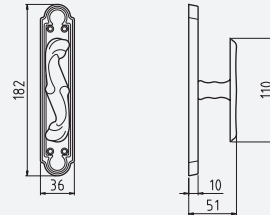
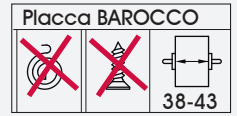
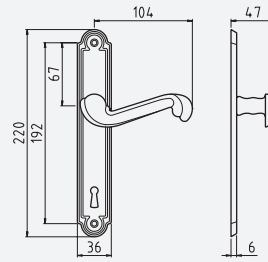

OBR-M45

	OBR M45	Conf. pz.
Q8 P90	44290089000	
Guarnitura Q8 placca patent 90	18,50	6
<i>Lever handle Q8 on key plate 90</i>		
Q8 P70	44290087000	
Guarnitura Q8 placca patent 70	18,50	6
<i>Lever handle Q8 on key plate 70</i>		
Q8 PY85	44290088500	
Guarnitura Q8 placca yale 85	18,50	6
<i>Lever handle Q8 on cyl. plate 85</i>		
GZ	44290401000	
Cremonese gioco GZ	16,30	10
<i>Window handle Q7 with mechanism</i>		
GZP	44290402000	
Cremonese gioco GZ + PERNI	16,70	10
<i>Window handle Q7 with mechanism</i>		
GZQ7	44290403000	
Cremonese gioco GZ + Q7	16,70	10
<i>Window handle Q7 with mechanism</i>		
MART	44290500000	
Martellina Q7	15,60	10
<i>Window handle Q7</i>		



OLV-M1

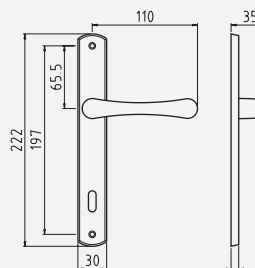

	OLV M1	OCS M18	OS M2	Conf. pz.
CB Q8 P90RS Guarnitura Q8 collo basso pl. stretta pat 90 <i>Lever handle Q8 on reduced key plate 90</i>	55429051001 32,80	55429051003 39,60	55429051008 32,80	1
CB Q8 P70RS Guarnitura Q8 collo basso pl. stretta pat 70 <i>Lever handle Q8 on reduced key plate 70</i>	55429057001 32,80	55429057003 39,60	55429057008 32,80	1
CB Q8 PY85RS Guarnitura Q8 collo basso pl. stretta yale 85 <i>Lever handle Q8 on reduced cyl. plate 85</i>	55429055001 32,80	55429055003 39,60	55429055008 32,80	1

GUARNITURA PENDENTE

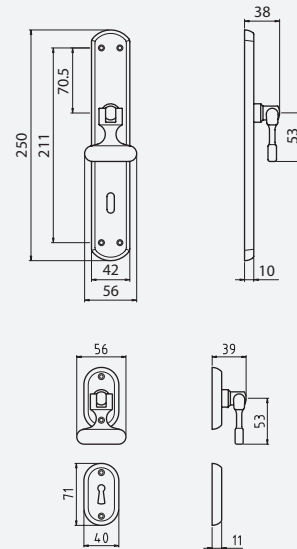

OLS-M33

	OLS M33	Conf. pz.
Q8 P90	55438089002	
Guarnitura Q8 placca patent 90		1
<i>Special handle Q8 on key plate 90</i>	64,90	
Q8 P70	55438087002	
Guarnitura Q8 placca patent 70		1
<i>Special handle Q8 on key plate 70</i>	64,90	
Q8 PY85	55438088502	
Guarnitura Q8 placca yale 85		1
<i>Special handle Q8 on cyl. plate 85</i>	64,90	

	OLS M33	Conf. pz.
Q8 R	55438280002	
Guarnitura Q8 ros. senza bocc.		2
<i>Lever handle Q8 on rose</i>	59,10	
Q8 RB	55438281002	
Guarnitura Q8 ros./bocc. patent		2
<i>Special handle Q8 on rose-key escutcheon</i>	63,20	
Q8 RBY	55438285002	
Guarnitura Q8 ros./bocc. Yale		2
<i>Special handle Q8 on rose-cyl escutcheon</i>	63,20	

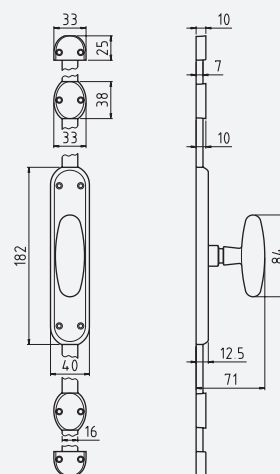

OLV-M1

	OLV M1	OGV M27	Conf. pz.
MPE			
Cremonese MP placca ovale	55434424001	55434424004	2
<i>Window handle MP oval plate</i>	31,90	31,90	
MPE + P + F			
Cremonese MP placca ovale con passanti e finali ovali	55434429001	55434429004	2
<i>Window handle MP oval plate with accessories</i>	44,50	44,50	
	OBR M45	OLV M1	Conf. pz.
ASTA CM 160	59234160000	59234160001	24
Asta cm 160 per cremonesi non verniciata	25,60	25,60	
<i>Half round bar cm. 160 not varnished for window handle MP</i>			
ASTA CM 240	59234240000	59234240001	24
Asta cm 240 per cremonesi non verniciata	35,80	35,80	
<i>Half round bar cm. 240 not varnished for window handle MP</i>			
PASS CREM OVALE	49234950000	49234950001	24
Passante per cremonese ovale	2,65	2,65	
<i>Accessories for window handle</i>			
FIN CREM OVALE	49234951000	49234951001	24
Finale per cremonese ovale	2,65	2,65	
<i>Accessories for window handle</i>			
FIN CREM MARMO	49234942000	49234942001	24
Finale per cremonese marmo	4,30	4,30	
<i>Accessories for window handle</i>			

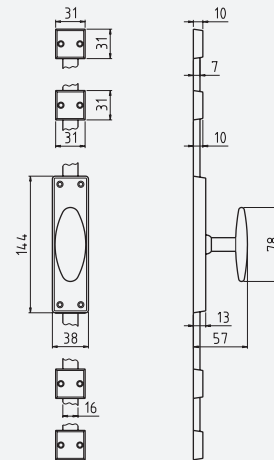

OLV-M1

	OLV M1	OGV M27	Conf. pz.
MPE			
Cremonese MP placca rettangolare	44834424501	44834424504	2
<i>Window handle MP with rectangular plate</i>	17,50	17,50	
MPE + P + F			
Cremonese MP placca rettangolare con passanti e finali quadrati	44834429501	44834429504	2
<i>Window handle MP with rectangular plate & accessories</i>	30,10	30,10	
	OBR M45	OLV M1	Conf. pz.
ASTA CM 160			
Asta cm 160 per cremonesi non verniciata	59234160000	59234160001	24
<i>Half round bar cm. 160 not varnished for window handle MP</i>	25,60	25,60	
ASTA CM 240			
Asta cm 240 per cremonesi non verniciata	59234240000	59234240001	24
<i>Half round bar cm. 240 not varnished for window handle MP</i>	35,80	35,80	
PASS CREM QUADRO			
Passante per cremonese quadrato	49234940000	49234940001	24
<i>Accessories for window handle</i>	2,65	2,65	
FIN CREM QUADRO			
Finale per cremonese quadrato	49234941000	49234941001	24
<i>Accessories for window handle</i>	2,65	2,65	
FIN CREM MARMO			
Finale per cremonese marmo	49234942000	49234942001	24
<i>Accessories for window handle</i>	4,30	4,30	

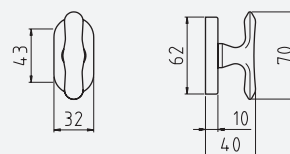

OLV-M1

	OLV M1	OCS M18	OCL M4	Conf. pz.
MART ROV	55036533001	55036533003	55036533007	
Martellina ros.ovale				12
<i>Window handle</i>	11,20	14,50	14,50	

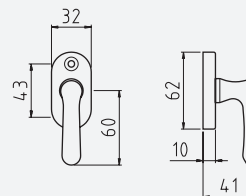

OLV-M1

	OLV M1	OCS M18	OCL M4	Conf. pz.
MART ROV IM	55036583001	55036583003	55036583007	
Martellina ros.ovale impugnatura maniglia				12
<i>Window handle</i>	11,20	14,50	14,50	



Fig. 1



Fig. 2



Fig. 3



Fig. 4



Fig. 5



Fig. 6



Fig. 7



Fig. 8



Fig. 9



Fig. 10



Fig. 11



Fig. 12



Fig. 13



Fig. 14

Fig. 1	GIOCO MARTELLINA Q.7 Mechanism for window handle spindle 7 mm	13350000070 3,90
Fig. 2	GIOCO EZ Mechanism for window handle spindle 7 mm	13340600070 3,90
Fig. 3	GIOCO EZ Q.7 Mechanism for window handle spindle 7 mm	13340700070 4,30
Fig. 4	GIOCO GRAZ PERNI Mechanism for window handle spindle 7 mm	13340200070 4,30
Fig. 5	GIOCO GRAZ PERNI Q.7 Mechanism for window handle spindle 7 mm	13340900070 4,70
Fig. 6	GIOCO MP Mechanism for window handle spindle 7 mm	13340400070 4,30
Fig. 7	GIOCO MP Q.7 Mechanism for window handle spindle 7 mm	13340500070 4,70
Fig. 8	GIOCO GOLA LUPO CENTRALE Mechanism for window handle spindle 7 mm	13340800070 6,50
Fig. 9	GIOCO GOLA LUPO LATERALE Mechanism for window handle spindle 7 mm	13340850070 6,50
Fig. 10	GIOCO TIPO TOSCANO Mechanism for window handle spindle 7 mm	13341500070 3,90
Fig. 11	GIOCO CON ALETTE 14x20 Mechanism for window handle spindle 7 mm	13342400070 4,30
Fig. 12	GIOCO CON ALETTE 11x33 Mechanism for window handle spindle 7 mm	13342400170 4,30
Fig. 13	GIOCO GRAZ JOLLY DA APPLICARE Mechanism for window handle spindle 7 mm	13341005070 2,65
Fig. 14	GIOCO EZ JOLLY DA APPLICARE Mechanism for window handle spindle 7 mm	13341105070 3,05

ROS 45x9

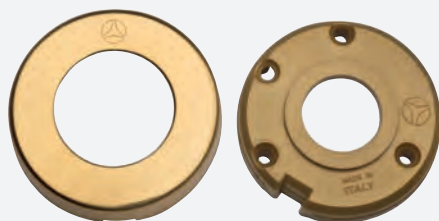

- supporto in polimero
- molla tradizionale dx o sx
- maniglia solidale
- non predisposta per viti passanti

- *plastic support*
- *standard spring lh/rh*
- *handle fixed on the rose*
- *not available for through bolts*

ROS 45x9 NOVECENTO

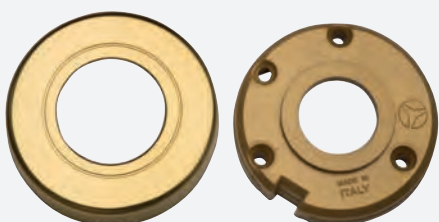

- supporto in polimero
- molla tradizionale dx o sx
- maniglia solidale
- non predisposta per viti passanti

- *plastic support*
- *standard spring lh/rh*
- *handle fixed on the rose*
- *not available for through bolts*

ROS 50x7-0005

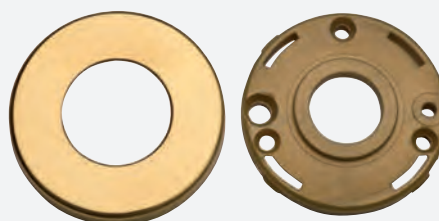

- supporto in polimero
- molla tradizionale dx o sx
- maniglia solidale
- predisposta per viti passanti interasse mm 38 autofilettanti o metriche

- *plastic support*
- *standard spring lh/rh*
- *handle fixed on the rose*
- *available for through bolts - self-drilling screw/metric screws*

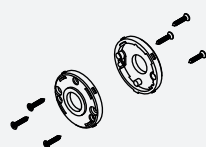

VL=viti legno
VL=wood screws

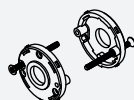

VPA=viti passanti autofilettanti
VPA=through bolts self-drilling screws

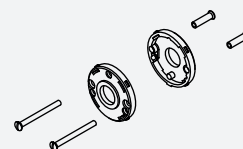

VPM=viti passanti metriche
VPA=through bolts metric screws

ROS 545

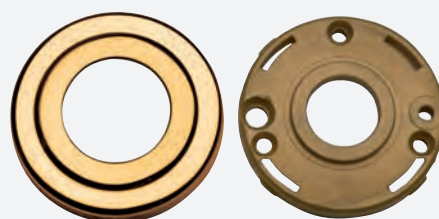

- supporto in polimero
- molla tradizionale dx o sx
- maniglia solidale
- predisposta per viti passanti interasse mm 38 autofilettanti o metriche

- *plastic support*
- *standard spring lh/rh*
- *handle fixed on the rose*
- *available for through bolts - self-drilling screw/metric screws*

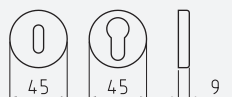

	OLV	OCS	OGV	OCL	OS	G-PLUS
BOC PAT Bocchetta patent <i>Key escutcheon</i>	55748631001	55748631003	55748631004	55748631007	55748631008	55748631050
	2,05	2,80	2,05	2,80	2,05	6,00
BOC YALE Bocchetta Yale <i>Cyl.key escutcheon</i>	55748635001	55748635003	55748635004	55748635007	55748635008	55748635050
	2,05	2,80	2,05	2,80	2,05	6,00

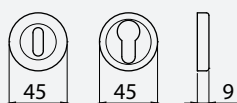

	OBR	OLV	OCL	OLD	OFA
BOC PAT Bocchetta patent <i>Key escutcheon</i>	55198631000	55198631001	55198631007	55198631028	55198631029
	2,70	2,70	3,50	2,70	3,70
BOC YALE Bocchetta Yale <i>Cyl.key escutcheon</i>	55198635000	55198635001	55198635007	55198635028	55198635029
	2,70	2,70	3,50	2,70	3,70



	OLV	OCS	OGV	OCL	OS
BOC PAT Bocchetta patent <i>Key escutcheon</i>	55748631301	55748631303	55748631304	55748631307	55748631308
	2,30	3,05	2,30	3,05	2,30
BOC BB Bocchetta BB <i>Key escutcheon</i>	55748631201	55748631203	55748631204	55748631207	55748631208
	2,30	3,05	2,30	3,05	2,30
BOC PZ Bocchetta Yale <i>Cyl.key escutcheon</i>	55748635301	55748635303	55748635304	55748635307	55748635308
	2,30	3,05	2,30	3,05	2,30

	ONS	OLD	OFA	ONL	OANT
BOC PAT Bocchetta patent <i>Key escutcheon</i>	55748631327	55748631328	55748631329	55748631330	55748631342
	3,00	1,95	3,20	3,00	2,15
BOC BB Bocchetta BB <i>Key escutcheon</i>	55748631227	55748631228	55748631229	55748631230	55748631242
	3,00	1,95	3,20	3,00	2,15
BOC PZ Bocchetta Yale <i>Cyl.key escutcheon</i>	55748635327	55748635328	55748635329	55748635330	55748635342
	3,00	1,95	3,20	3,00	2,15

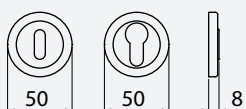

	OLS	ONL - ONS	OCL - OCS
BOC PAT Bocchetta patent <i>Key escutcheon</i>	R054563106502	R054563106557	R054563106559
	2,00	2,40	2,30
BOC PZ Bocchetta Yale <i>Cyl.key escutcheon</i>	R054563506502	R054563506557	R054563506559
	2,00	2,40	2,30

ROS 52x10-575

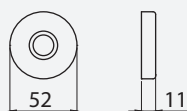
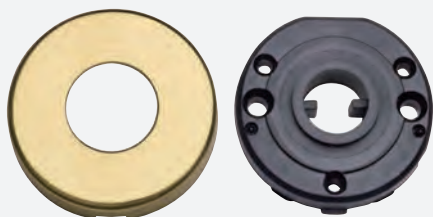

- supporto in polimero con molla ambidestra inserita
- maniglia staccata
- predisposta per viti passanti interasse mm 38 autofilettanti o metriche

- *plastic support with spring loaded lh/rh*
- *detached handle*
- *available for through bolts- self-drilling screw/metric screws*

ROS GOLF

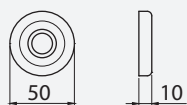

- supporto in ottone
- molla tradizionale dx o sx
- maniglia solidale
- non predisposta per viti passanti

- *solid support*
- *standard spring lh/rh*
- *handle fixed on rose*
- *not available for through bolts*

ROS 558

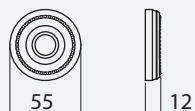

- supporto in ottone
- molla tradizionale dx o sx
- maniglia solidale
- predisposta per viti passanti interasse mm 38 metriche

- *solid support*
- *standard spring lh/rh*
- *handle fixed on rose*
- *available for through bolts metric screws*

ROS 65



- supporto in ottone
- non predisposta per molla
- maniglia staccata
- predisposta per viti passanti interasse mm 38 metriche

- *brass support*
- *not available for spring*
- *detached handle*
- *available for through bolts metric*

ROS 61

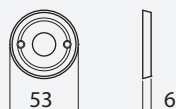
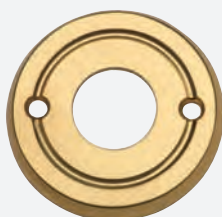

- monoblocco
- non predisposta per molla
- maniglia staccata
- predisposta per viti passanti interasse mm 38 metriche

- *solid rose*
- *not available for spring*
- *detached handle*
- *available for trough bolts metric screws*

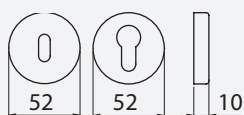

	OLV	OCS	OGV	OCL	OS	ONS
BOC PAT Bocchetta patent <i>Key escutcheon</i>	55048631301	55048631303	55048631304	55048631307	55048631308	55048631327
	2,50	3,30	2,50	3,30	2,50	3,45
BOC YALE Bocchetta yale <i>Cyl.key escutcheon</i>	55048635301	55048635303	55048635304	55048635307	55048635308	55048635327
	2,50	3,30	2,50	3,30	2,50	3,45

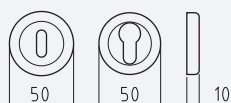

	OLV	OCS	OCL	G-PLUS
BOC PAT Bocchetta patent <i>Key escutcheon</i>	55148631001	55148631003	55148631007	55148631050
	8,20	9,60	9,60	12,80
BOC YALE Bocchetta yale <i>Cyl.key escutcheon</i>	55148635001	55148635003	55148635007	55148635050
	8,20	9,60	9,60	12,80

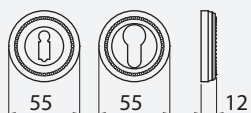

	OLV	OLS	OCL	OLD	OFA	OANT	OCL/OCS
BOC BB Bocchetta BB <i>Key escutcheon</i>	R055863126501	R055863126502	R055863126507	R055863126528	R055863126529	R055863126542	R055863126559
	13,30	13,30	13,60	11,50	14,00	13,30	13,60
BOC PZ Bocchetta Yale <i>Cyl.key escutcheon</i>	R055863506501	R055863506502	R055863506507	R055863506528	R055863506529	R055863506542	R055863506559
	13,30	13,30	13,60	11,50	14,00	13,30	13,60

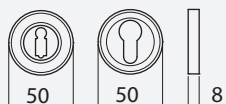

	OLV	OCS	OCL
BOC BB Bocchetta BB <i>Key escutcheon</i>	R066063126501	R066063126503	R066063126507
	7,80	8,00	8,00
BOC PZ Bocchetta Yale <i>Cyl.key escutcheon</i>	R066063506501	R066063506503	R066063506507
	7,80	8,00	8,00

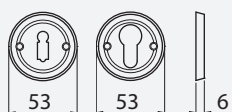

	OLV
BOC BB Bocchetta BB <i>Key escutcheon</i>	R006264126501
	4,90
BOC PZ Bocchetta Yale <i>Cyl.key escutcheon</i>	R006264506501
	4,90

ROS 45x10 V.V.



- monoblocco
- non predisposta per molla
- maniglia solidale
- non predisposta per viti passanti

- *solid rose*
- *not available for spring*
- *fixed handle*
- *not available for through bolts*

ROS ARIANNA

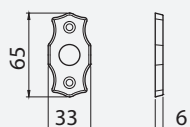

- monoblocco
- non predisposta per molla
- maniglia solidale
- non predisposta per viti passanti

- *solid rose*
- *not available for spring*
- *fixed handle*
- *not available for through bolts*

ROS VERA

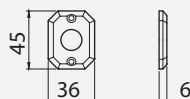

- monoblocco
- non predisposta per molla
- maniglia solidale
- non predisposta per viti passanti

- *solid rose*
- *not available for spring*
- *fixed handle*
- *not available for through bolts*

ROS CHIARA

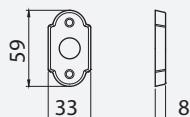

- monoblocco
- molla tradizionale dx o sx
- maniglia solidale
- non predisposta per viti passanti

- *solid rose*
- *standard spring lh/rh*
- *fixed handle*
- *not available for through bolts*

ROS GIOIA

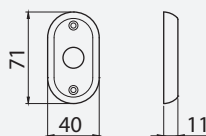

- monoblocco
- molla tradizionale dx o sx
- maniglia solidale

- *solid rose with standard spring lh/rh*
- *standard spring lh/rh*
- *fixed handle*

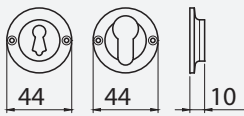

	OBR	OLV	OCL	OLD	OFA
BOC PAT Bocchetta patent <i>Key escutcheon</i>	55198641000	55198641001	55198641007	55198641028	55198641029
	5,30	5,30	5,80	5,30	6,60
BOC YALE Bocchetta Yale <i>Cyl.key escutcheon</i>	55198645000	55198645001	55198645007	55198645028	55198645029
	5,30	5,30	5,80	5,30	6,60

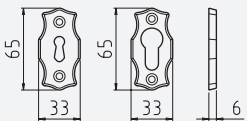

	OLV	OGV	OF	OLD
BOC PAT Bocchetta patent <i>Key escutcheon</i>	55648601001	55648601004	55648601006	55648601028
	3,70	3,70	3,70	3,70
BOC YALE Bocchetta Yale <i>Cyl.key escutcheon</i>	55648605001	55648605004	55648605006	55648605028
	3,70	3,70	3,70	3,70

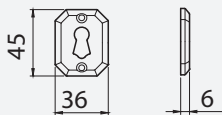

	OLV	OGV
BOC PAT Bocchetta patent <i>Key escutcheon</i>	55598601001	55598601004
	3,90	3,90

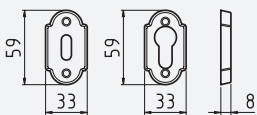

	OLD	OFA
BOC PAT Bocchetta patent <i>Key escutcheon</i>	55898601028	55898601029
	9,10	10,20
BOC YALE Bocchetta Yale <i>Cyl. key escutcheon</i>	55898605028	55898605029
	9,10	10,20

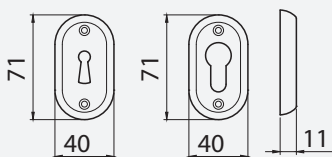

	OLV	OGV	OS
BOC PAT Bocchetta patent <i>Key escutcheon</i>	55448621001	55448621004	55448621008
	5,20	5,20	5,20
BOC YALE Bocchetta Yale <i>Cyl.key escutcheon</i>	55448625001	55448625004	55448625008
	5,20	5,20	5,20

ROS 45x45x10

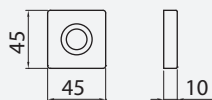
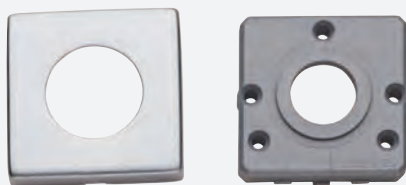

- supporto in polimero
- molla tradizionale dx o sx
- maniglia solidale
- non predisposta per viti passanti

- *plastic support*
- *standard spring lh/rh*
- *fixed handle*
- *not available for through bolts*

ROS 50x50x10-574

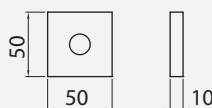

- supporto in polimero
- molla tradizionale dx o sx
- maniglia solidale
- predisposta per viti passanti interasse mm 38 autofilettanti o metriche

- *plastic support*
- *standard spring lh/rh*
- *fixed handle*
- *available for through bolts self-drilling screw/metric screws*

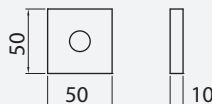

- supporto in polimero con molla ambidestra inserita
- maniglia staccata
- predisposta per viti passanti interasse mm 38 autofilettanti o metriche

- *plastic support with spring loaded lh/rh*
- *detached handle*
- *available for through bolts self-drilling screw/metric screws*

ROS 544

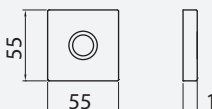
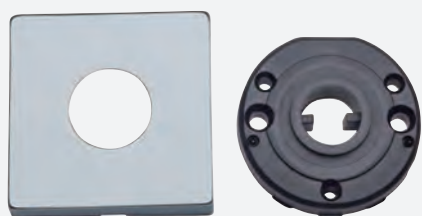

- supporto in polimero con molla ambidestra inserita
- maniglia staccata
- predisposta per viti passanti interasse mm 38 autofilettanti o metriche

- *plastic support with spring loaded lh/rh*
- *detached handle*
- *available for through bolts self-drilling screw/metric screws*

ROS 30x30

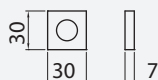
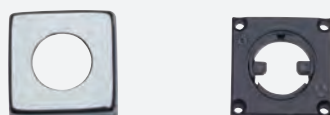

- supporto in polimero con molla ambidestra inserita
- maniglia staccata
- non predisposta per viti passanti

- *plastic support with spring loaded lh/rh*
- *detached handle*
- *not available for through bolts*

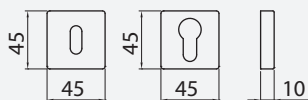

	OCS	OCL
BOC PAT Bocchetta patent <i>Key escutcheon</i>	55448653003	55448653007
	2,40	2,40
BOC YALE Bocchetta Yale <i>Cyl.key escutcheon</i>	55448655503	55448655507
	2,40	2,40

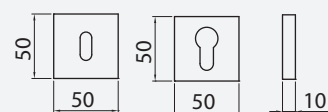

	OLV	OCS	OCL	ONS
BOC PAT Bocchetta patent <i>Key escutcheon</i>	55448651001	55448651003	55448651007	55448651027
	3,70	4,20	4,20	4,40
BOC YALE Bocchetta Yale <i>Cyl.key escutcheon</i>	55448655001	55448655003	55448655007	55448655027
	3,70	4,20	4,20	4,40

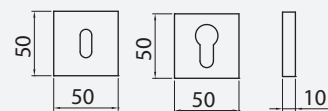

	ACL	F1-SAT
BOC PAT Bocchetta patent <i>Key escutcheon</i>	77498651017	77498651033
	5,30	3,20
BOC YALE Bocchetta Yale <i>Cyl.key escutcheon</i>	77498655017	77498655033
	5,30	3,20

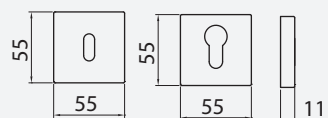

	ZCL	ZCS	ZNS	ZNL
BOC BB Bocchetta BB <i>Key escutcheon</i>	R054465106507	R054465106513	R054465106527	R054465106530
	5,30	5,30	5,60	5,60
BOC PZ Bocchetta Yale <i>Cyl. key escutcheon</i>	R054465506507	R054465506513	R054465506527	R054465506530
	5,30	5,30	5,60	5,60

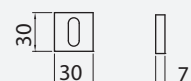

	FI-SAT	ACL	ACS
BOC PAT Bocchetta patent <i>Key escutcheon</i>	77498652833	55448652803	55448652807
	2,20	2,40	2,40

ROS 554

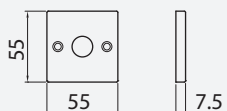
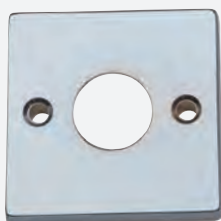

- monoblocco
- predisposta per molla tradizionale dx o sx
- maniglia solidale
- predisposta per viti passanti interasse mm 38 metriche
- *solid rose*
- *available for standard spring lh/rh*
- *fixed handle*
- *available for metric through screws*

ROS 52x52-573

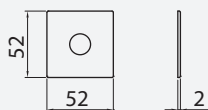

- monoblocco applicata alla porta con bi-adesivo
- non predisposta per molla
- *solid rose glued to the door*
- *not available for spring*

ROS GRAN PRIX

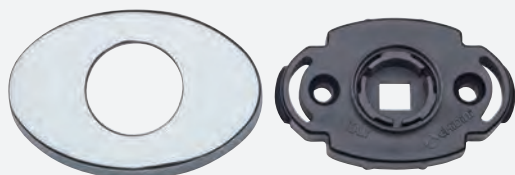

- supporto in polimero con molla ambidestra inserita
- maniglia staccata
- predisposta per viti passanti interasse mm 38 metriche
- *plastic support with spring loaded lh/rh*
- *detached handle*
- *available for metric through bolts*

ROS 30x60-0006

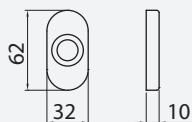

- supporto in polimero
- maniglia staccata
- predisposta per molla tradizionale dx o sx con maniglia solidale
- *plastic support*
- *detached handle*
- *available for standard spring lh/rh*

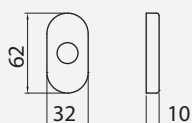

- supporto in polimero con molla ambidestra inserita
- maniglia staccata
- *plastic support with spring loaded lh/rh*
- *detached handle*

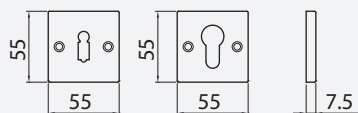

	ZCL	ZCS	ZNS	ZNL
BOC BB C/BUSS. Bocchetta Patent con buss. <i>Key escutcheon with pins</i>	R055461124507 4,90	R055461124513 4,90	R055461124527 5,10	R055461124530 5,10
BOC PZ C/BUSS. Bocchetta Yale con buss. <i>Cyl.key escutcheon with pins</i>	R055461504507 4,90	R055461504513 4,90	R055461504527 5,10	R055461504530 5,10

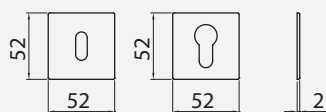

	ZCL	GCTOL	ZCS	ZNS
BOC PAT Bocchetta patent <i>Key escutcheon</i>	66448651607 3,60	66448651612 3,40	66448651613 3,60	66448651627 3,80
BOC YALE Bocchetta Yale <i>Cyl.key escutcheon</i>	66448655607 3,60	66448655612 3,40	66448655613 3,60	66448655627 3,80

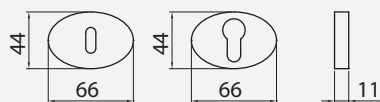

	ACS	ACL	ANO
BOC PAT Bocchetta patent <i>Key escutcheon</i>	77968621413 4,00	77968621417 4,00	77968621416 3,70
BOC YALE Bocchetta yale <i>Cyl.key escutcheon</i>	77968625213 4,00	77968625217 4,00	77968625216 3,70

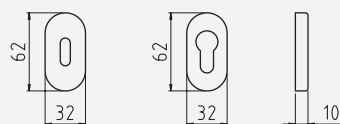

	OLV	OCS	OGV	OCL	OS
BOC OVALE PAT Bocchetta ovale patent <i>Oval key escutcheon</i>	55498621001 5,50	55498621003 6,20	55498621004 5,50	55498621007 6,20	55498621008 5,50
BOC OVALE YALE Bocchetta ovale yale <i>Oval cyl. key escutcheon</i>	55498625001 5,50	55498625003 6,20	55498625004 5,50	55498625007 6,20	55498625008 5,50

ROS 30x60-00C6

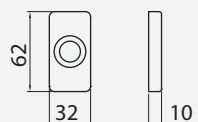

- supporto in polimero
- maniglia staccata
- predisposta per molla tradizionale dx o sx con maniglia solidale

- *plastic support*
- *detached handle*
- *available for standard spring lh/rh with fixed handle*

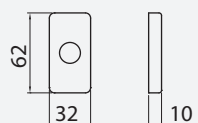

- supporto in polimero con molla ambidestra inserita
- maniglia staccata

- *plastic support with spring loaded lh/rh*
- *detached handle*

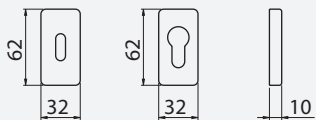

	OLV	OCS	OCL
BOC PAT	55448611501	55448611503	55448611507
Bocchetta patent	3,50	3,90	3,90
<i>Key escutcheon</i>			
BOC YALE	55448615501	55448615503	55448615507
Bocchetta Yale	3,50	3,90	3,90
<i>Cyl.key escutcheon</i>			

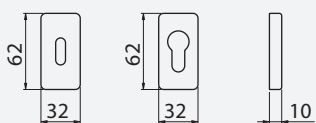

	ACL	F1-SAT
BOC PAT	77498611517	77498611533
Bocchetta patent	4,90	2,85
<i>Key escutcheon</i>		
BOC YALE	77498615517	77498615533
Bocchetta Yale	4,90	2,85
<i>Cyl.key escutcheon</i>		

MILENA

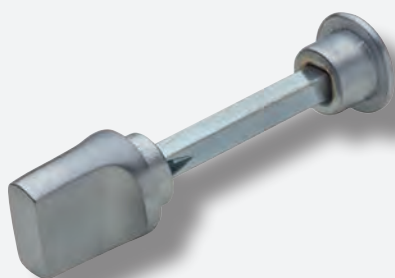

OCS-M18

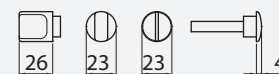

	OLV M1	OCS M18	OGV M27	OCL M4	OS M2	ONS M9	ONL M7	G-PLUS M36
NOTT WC Q6 Nottolino WC Q.6 senza rosette <i>Toilet set - spindle 6 mm. without roses</i>	55448229001	55448229003	55448229004	55448229007	55448229008	55448229027	55448229030	55448229050
	8,20	11,00	8,20	11,00	8,20	11,50	11,00	14,40
NOTT WC Q8 Nottolino WC Q.8 senza rosette <i>Toilet set - spindle 6 mm. without roses</i>	55448229401	55448229403	55448229404	55448229407	55448229408	55448229427	55448229430	55448229450
	8,20	11,00	8,20	11,00	8,20	11,50	11,00	14,40

MEZZALUNA

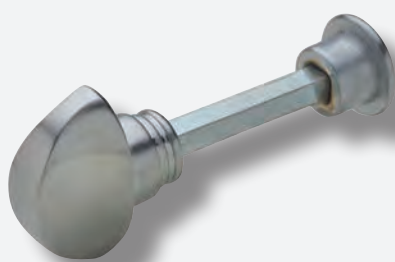

OCS-M18

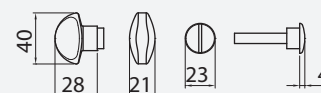

	OLV M1	OCS M18	OGV M27	OCL M4	OS M2	ONS M9	ONL M7	G-PLUS M36
NOTT WC Q6 Nottolino WC Q.6 senza rosette <i>Toilet set - spindle 6 mm. without roses</i>	55998229001	55998229003	55998229004	55998229007	55998229008	55998229027	55998229030	55998229050
	6,10	6,60	5,70	6,60	6,40	6,90	6,60	10,90
NOTT WC Q8 Nottolino WC Q.8 senza rosette <i>Toilet set - spindle 6 mm. without roses</i>	55998229801	55998229803	55998229807	55998229807	55998229808	55998229827	55998229830	55998229850
	6,10	6,60	5,70	6,60	6,40	6,90	6,60	10,90

GOLF



OLV-M1

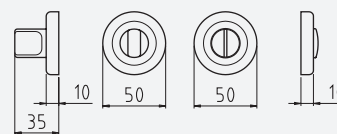

	OLV M1	OCS M18	OCL M4	G-PLUS M36
NOTT RWC	55148638001	55148638003	55148638007	55148638050
Nottolino WC Q.6 con rosette d.50 M+F				
<i>Toilet set - spindle 6 mm.</i>	26,00	31,40	31,40	39,90

MILENA



OLV-M1

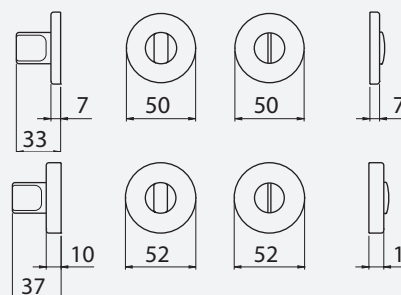
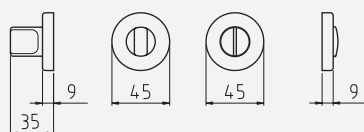

	OLV M1	OCS M18	OGV M27	OCL M4	OS M2	G-PLUS M36
NOTT RWC 45x9	55448638001	55448638003	55448638004	55448638007	55448638008	55448638050
Nottolino WC Q.6 con rosette						
<i>Toilet set - spindle 6 mm.with roses</i>	13,70	17,80	13,70	17,80	13,70	27,70
NOTT RWC 50x7	55448638301	55448638303	55448638304	55448638307	55448638308	n.d.
Nottolino WC Q.6 con rosette						
<i>Toilet set - spindle 6 mm.with roses</i>	14,10	18,30	14,10	18,30	14,10	
NOTT RWC 52x10	55448639801	55448639803	55448639804	55448639807	55448639808	n.d.
Nottolino WC Q.6 con rosette						
<i>Toilet set - spindle 6 mm.with roses</i>	14,50	18,80	14,50	18,80	14,60	

NOVECENTO



OLV-M1

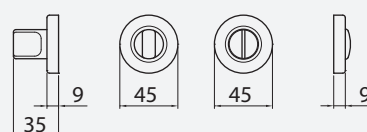

	OBR M45	OLV M1	OCL M4	OLD MV3	OFA M69
NOTT RWC	55198638000	55198638001	55198638007	55198638028	55198638029
Nottolino WC Q.6 con rosette					
<i>Toilet set - spindle 6 mm.with roses</i>	13,50	13,50	17,80	13,50	17,20

MILENA



OCS-M18

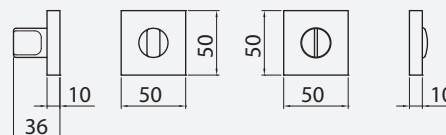

	OLV M1	OCS M18	OCL M7	ONS M9
NOTT RWC	55448668001	55448668003	55448668007	55448668027
Nottolino WC Q.6 con rosette				
<i>Toilet set - spindle 6 mm.with roses</i>	12,95	14,50	14,50	15,00

FRAME



F1-SAT

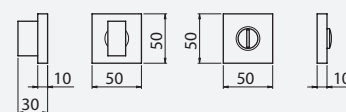

	ACL	F1-SAT
NOTT RWC	77472658017	77472658033
Nottolino WC Q.6 con rosette	22,10	17,90
<i>Toilet set - spindle 6 mm with roses</i>		

WING



ZCS

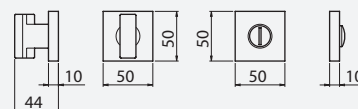

	ZCL	ZCS
NOTT RWC	66792658007	66792658013
Nottolino WC Q.6 con rosette	21,10	21,10
<i>Toilet set - spindle 6 mm with roses</i>		

DK-1P



- Gioco in plastica senza bussole/bussole D.9,5/bussole D.11,5
- Rosetta ovale/rettangolare
- Maniglia fissata con grano
- Possibilità di avere 8 scatti
- Sporgenza ferro Q.7 standard: mm 40
- Sporgenze ferro Q.7 a richiesta: mm 30/33/35/45/50

- *plastic mechanism without pins/ with pins D.9,5/ with pins D11,5*
- *oval rose/rectangular rose*
- *lever handle fixed by grub screw*
- *availability of 8 positions (45°)*
- *standard projection of spindle: 7 x 40 mm*
- *on request projection of the spindle: 7 x 30/33/35/45/50 mm*

DK-2P



- Gioco in plastica senza bussole/bussole D.9,5/bussole D.11,5
- Rosetta ovale/rettangolare
- Maniglia solidale senza grano
- Possibilità di avere 8 scatti
- Sporgenza ferro Q.7 standard: mm 40-35
- Sporgenze ferro Q.7 a richiesta: mm 45-40/35-30

- *plastic mechanism without pins/with pins D.9,5 mm/ with pins D11,5*
- *oval rose/rectangular rose*
- *lever handle fixed*
- *availability of 8 positions (45°)*
- *standard projection of spindle: 7x 40-35 mm*
- *on request projection of the spindle: 7 x 45-40mm/35-30mm*

DK-1F



- Gioco in ferro con bussole D.9,5
- Rosetta ovale/rettangolare
- Maniglia fissata con grano
- Disponibile solo con 4 scatti
- Sporgenza ferro Q.7 standard: mm 35
- Sporgenze ferro Q.7 a richiesta: mm 30/40

- *iron mechanism with pins D.9,5 mm*
- *oval rose/rectangular rose*
- *lever handle fixed by grub screw*
- *available only with 4 positions (90°)*
- *standard projection of spindle: 7 x 35 mm*
- *on request projection of the spindle: 7 x 30-40mm*

DK-2F



- Gioco in ferro con bussole D.9,5
 - Rosetta ovale/rettangolare
 - Maniglia solidale senza grano
 - Possibilità di avere 8 scatti
 - Sporgenza ferro Q.7 standard: mm 40-28
- *iron mechanisme with pins D 9,5 mm*
- *oval rose/rectangula rose*
- *fixed handle*
- *availability of 8 positions (45 °)*
- *standard projection of spindle 7 x 40-28 mm*

DK-3P

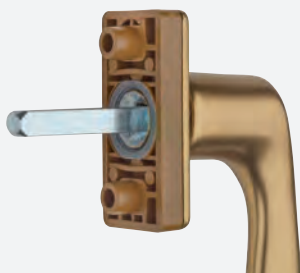

- Gioco in plastica senza bussole/bussole D.9,5/bussole D.11,5 a vista sui lati
 - Rosetta rettangolare rotante
 - Maniglia solidale senza grano
 - Possibilità di avere 8 scatti
 - Sporgenza ferro Q.7 standard: mm 40
 - Sporgenze ferro Q.7 a richiesta: mm 30/33/35/45
- *plastic mechanisme without pins/with pins D.9,5 mm/ with pins D11,5*
- *rotating rectangular rose*
- *lever handle fixed without grub screw*
- *availability of 8 positions (45°)*
- *standard projection of spindle: 7 x 40 mm*
- *on request projection of spindle: 7 x 30/33/35/45 mm*

DK-4P

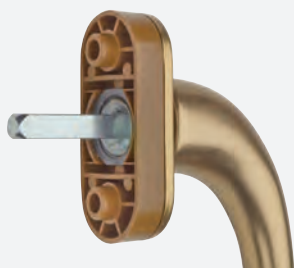

- Gioco in plastica senza bussole/bussole D.9,5/bussole D.11,5 a vista sui lati
 - Rosetta ovale rotante
 - Maniglia solidale senza grano
 - Possibilità di avere 8 scatti
 - Sporgenza ferro Q.7 standard: mm 40
 - Sporgenze ferro Q.7 a richiesta: mm 30/33/35/45
- *plastic mechanisme without pins/with pins D.9,5 mm/pins D11,5*
- *rotating rectangular rose*
- *fixed handle without grub screw*
- *availability of 8 positions (45 °)*
- *standard projection of spindle: 7 x 40 mm*
- *on request projection of spindle: 7 x 30/33/35/45 mm*

DK-SIC/P



- Sistema di sicurezza con bussole D.9,5 abbinato a DK-2P senza bussole
- Rosetta ovale
- Maniglia solidale senza grano
- Disponibile solo con 4 scatti
- Sporgenza ferro Q.7 standard: mm 40
- Sporgenze ferro Q.7 a richiesta mm 30/35/45

- *safety system with pins D. 9,5mm in addition to DK-2P without pins*
- *oval rose*
- *fixed handle without grub screw*
- *available only with 4 positions (90°)*
- *standard projection of spindle: 7 x 40 mm*
- *on request projection of spindle: 7 x 30/35/45 mm*

DK-SIC/F



- Sistema di sicurezza con bussole D.9,5 abbinato a DK-1F con bussole D.9,5
- Rosetta ovale
- Maniglia fissata con grano
- Disponibile solo con 4 scatti
- Sporgenza ferro Q.7 standard: mm 40
- Sporgenze ferro Q.7 a richiesta: mm 30/35/45

- *safety system with pins D. 9,5mm in addition to DK-1F with pins*
- *oval rose*
- *fixed handle by grub screw*
- *available only with 4 positions (90°)*
- *standard projection of spindle: 7 x 40 mm*
- *on request projection of spindle: 7 x 30/35/45 mm*

SISTEMA RG



- Sistema di sicurezza per DK con chiusura a cilindro
- Movimento con bussole D.9,5 in lega di zinco pressofusa grezza
- Cilindro e chiave in lega di zinco pressofusa e nichelata
- Copertura in ottone varie finiture
- Maniglia fissata con grano
- Disponibile solo con 4 scatti
- Sporgenze ferro Q.7 disponibili: mm 31/35/42

- *safety system for Dk with cylinder*
- *zinc - alloy die casted mechanism with pins D.9,5*
- *cylinder and key , nickel - plated*
- *brass cover in different finishing*
- *lever handle fixed by grub screw*
- *available only with 4 positions (90°)*
- *on request projection of spindle: 7 x 31/35/42 mm*

MILENA

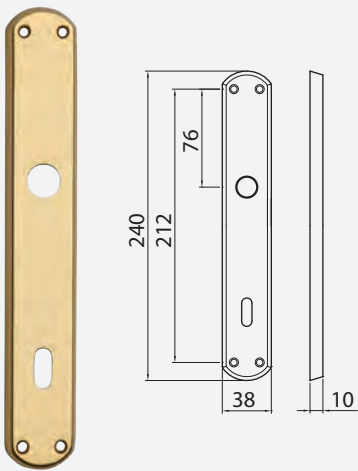

MONICA 2

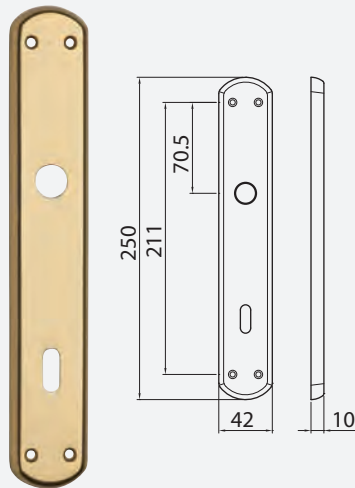

ELY

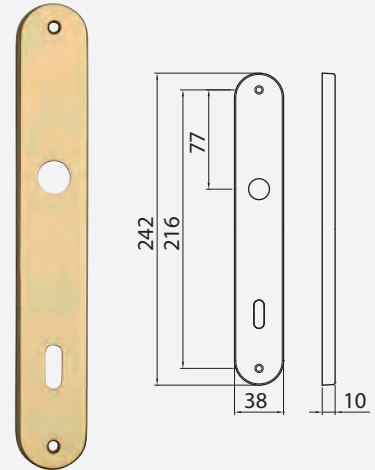

ELBA

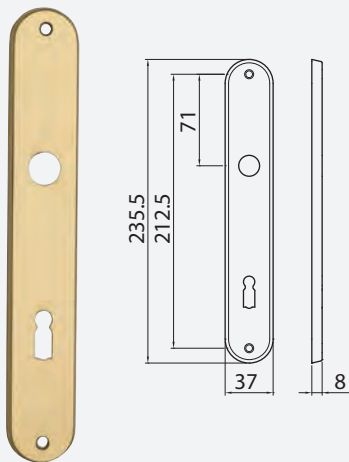

EVA

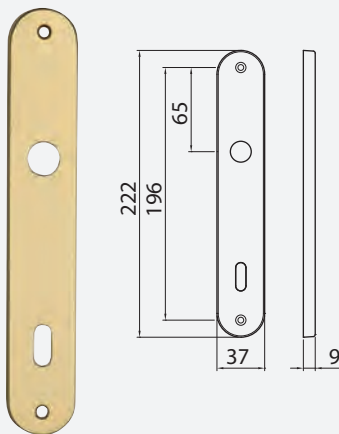

UNO

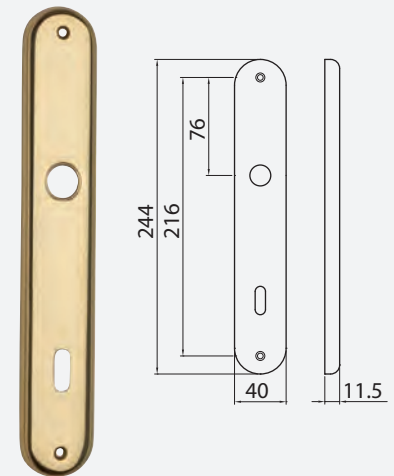

STRETTA

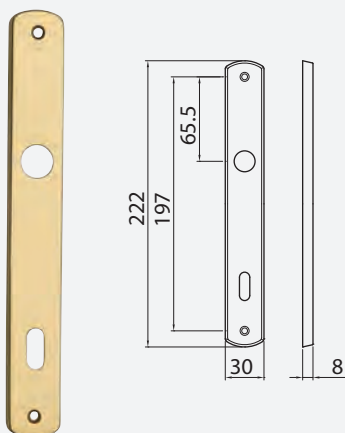

OVALE CORTA

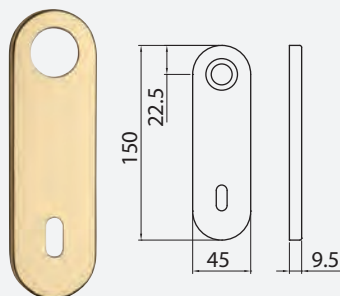

RETT CORTA

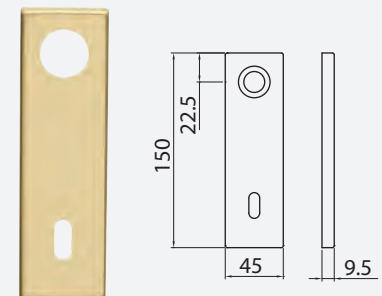

S

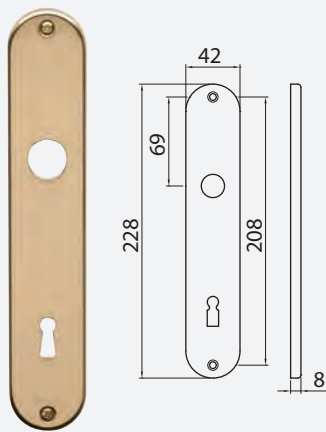

NOVECENTO

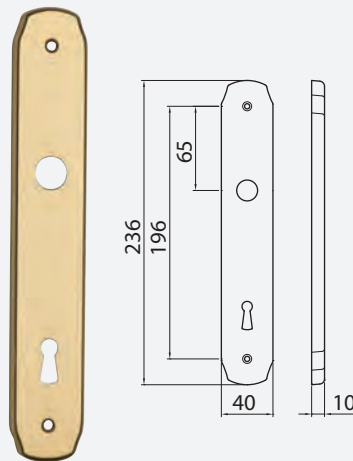

ARIANNA

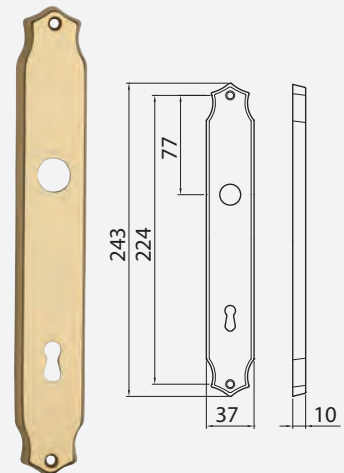

IMPERO

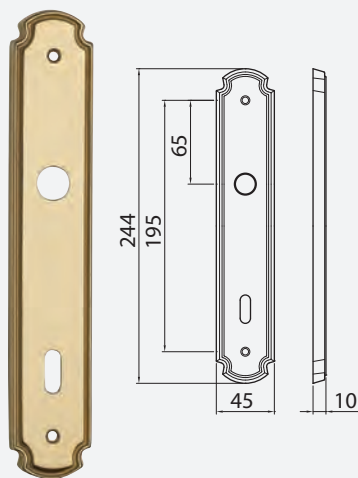

TIROL

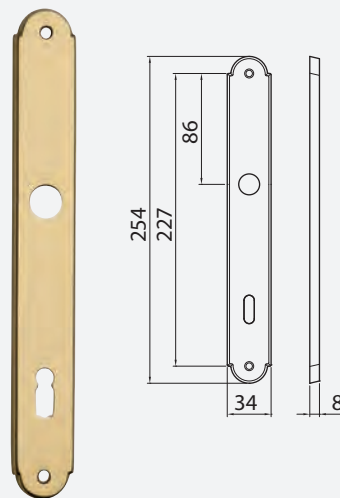

VERA

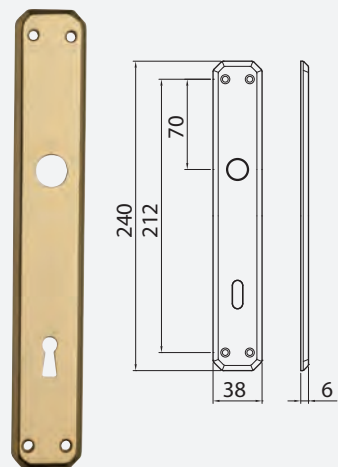

21

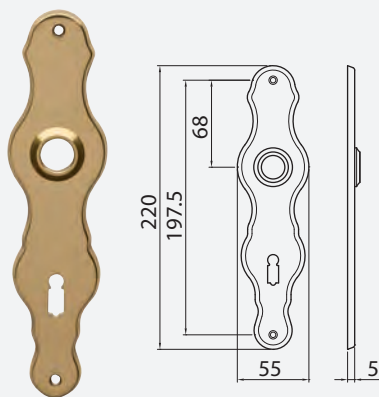

23

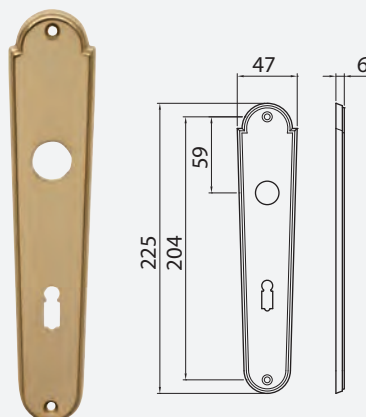

41

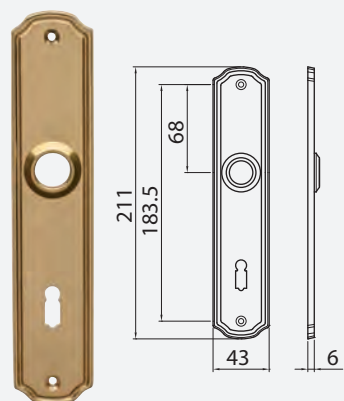

45

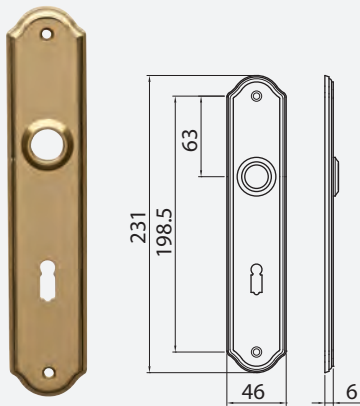

46

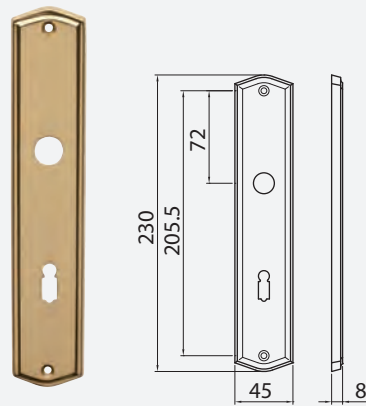

818

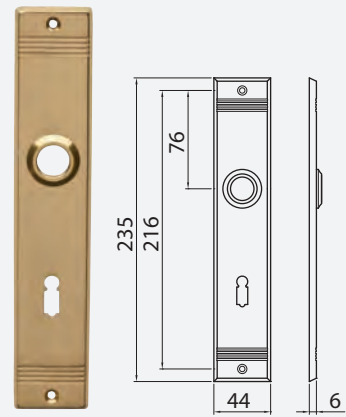

836

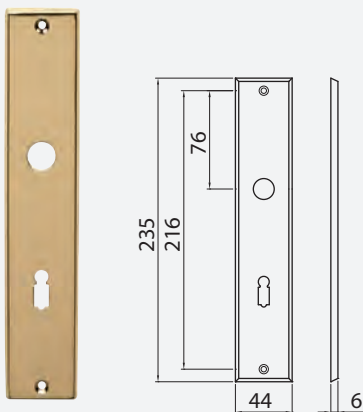

870

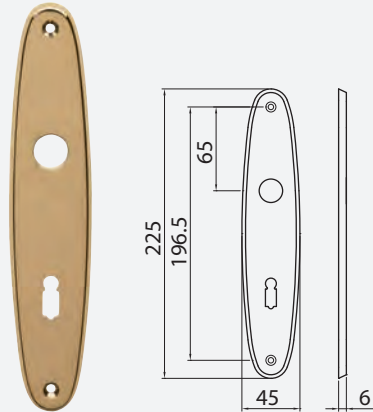

883

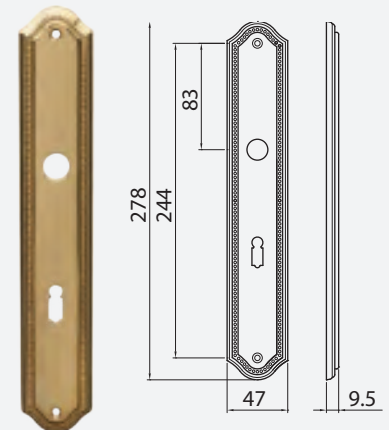

886

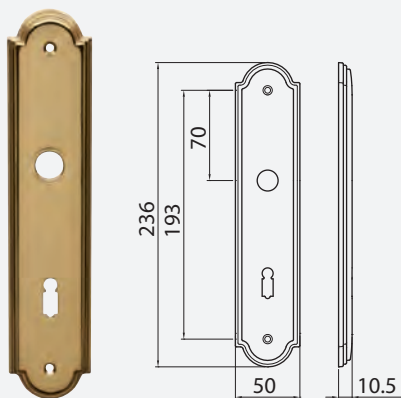

888

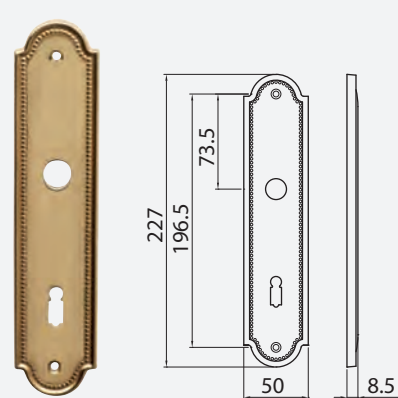



SICUREZZA SECURITY

4

■ KIT R304/301	280
■ KIT R306/301	280
■ KIT R312/301	279
■ KIT R315/301	279
■ KIT R320/303	271
■ KIT R322/305	274-275
■ KIT R323/305	275
■ KIT R326/305	276
■ KIT R327/305	276
■ KIT R404/400	278
■ KIT R406/400	278
■ KIT R412/400	277
■ KIT R415/400	277
■ KIT R519/509	282
■ KIT R539/988	281
■ KIT R565/564	283
■ KIT R626/599	272-273
■ KIT R627/599	272-273
■ KIT R632/601	270
■ KIT R633/601	270



OLV-M1

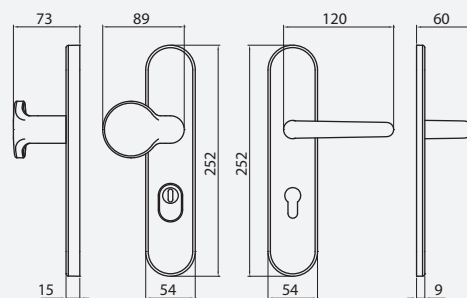
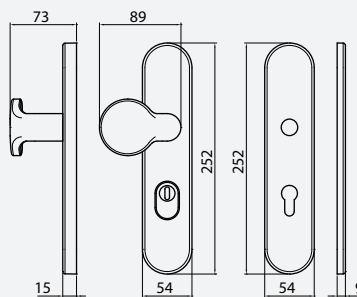

	OLV M1	OCS M18	ONS M9	Conf. pz.
632 / 15 / 601 / 9 / 632 Q8 KS72 S/MANIGLIA Guarnitura di sicurezza con pomolo senza maniglia <i>Security set with knob without handle</i>	R06320601980201 165,20	R06320601980203 170,30	R06320601980227 172,30	1
633 / 15 / 601 / 9 / 632 Q10 KS92 S/MANIGLIA Guarnitura di sicurezza con pomolo senza maniglia <i>Security set with knob without handle</i>	R06330601902201 166,10	R06330601902203 171,30	R06330601902227 173,20	1
632 / 15 / 601 / 9 / 632 / 52 Q8 KS72 C/MANIGLIA Guarnitura di sicurezza con pomolo + maniglia <i>Security set with knob + handle</i>	R06320601980801 179,30	R06320601980803 185,90	R06320601980827 188,20	1
633 / 15 / 601 / 9 / 632 / 52 Q10 KS92 C/MANIGLIA Guarnitura di sicurezza con pomolo + maniglia <i>Security set with knob + handle</i>	R06330601902801 180,20	R06330601902803 186,80	R06330601902827 189,20	1



OLV-M1

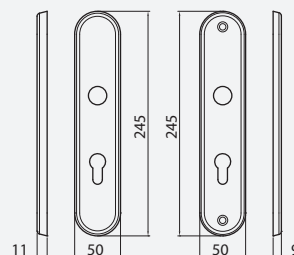
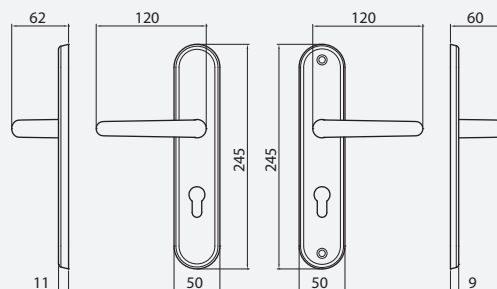
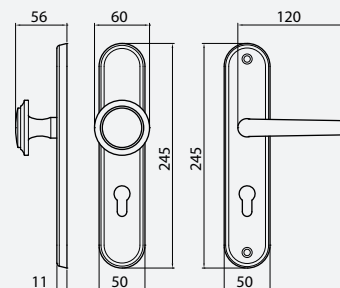
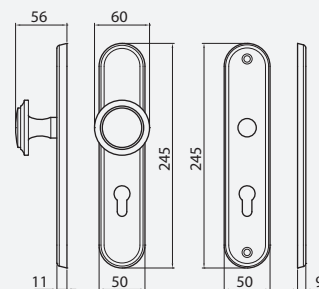

320 / 11 / 303 / 9 / 57 Q8 PZ72 S/MANIGLIA
Guarnitura di sicurezza con pomolo senza maniglia
Security set with knob without handle

320 / 11 / 303 / 9 / 57 / 52 Q8 PZ72 C/MANIGLIA
Guarnitura di sicurezza con pomolo + maniglia
Security set with knob + handle

308 / 11 / 303 / 9 / 52 Q8 PZ72 MAN+MAN
Guarnitura di sicurezza con maniglia + maniglia
Security set with handle + handle

308 / 11 / 303 / 9 PLACCHE PZ72
Guarnitura di sicurezza solo placche
Security set only plates

OLV M1	ONS M9	Conf. pz.
R03200303880101	R03200303880127	1
119,10	135,60	
R03200303880901	R03200303880927	1
133,20	150,60	
R03080303780901	R03080303780927	1
134,10	151,60	
R03080303790101	R03080303790127	1
105,90	121,50	



OCS-M18

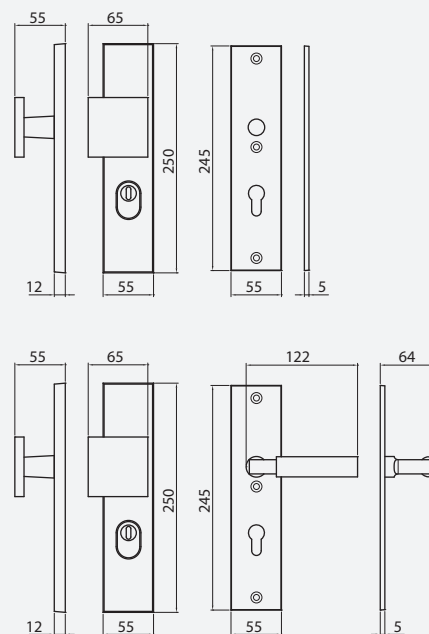

	OCS M18	OCL M4	ONL M7	Conf. pz.
626 / 12 / 599 / 5 / 625 Q8 KS72 S/MANIGLIA Guarnitura di sicurezza con pomolo senza maniglia <i>Security set with knob without handle</i>	R06260599980203 153,90	R06260599980207 158,20	R06260599980230 158,20	1
627 / 12 / 599 / 5 / 625 Q10 KS92 S/MANIGLIA Guarnitura di sicurezza con pomolo senza maniglia <i>Security set with knob without handle</i>	R06270599902203 154,90	R06270599902207 159,10	R06270599902230 159,10	1
626 / 12 / 599 / 5 / 625 / 988 Q8 KS72 C/MANIGLIA Guarnitura di sicurezza con pomolo + maniglia <i>Security set with knob + handle</i>	R06260599980803 181,10	R06260599980807 186,40	R06260599980830 186,40	1
627 / 12 / 599 / 5 / 625 / 988 Q10 KS 92 C/MANIGLIA Guarnitura di sicurezza con pomolo + maniglia <i>Security set with knob + handle</i>	R06270599902803 182,20	R06270599902807 187,30	R06270599902830 187,30	1



OCS-M18

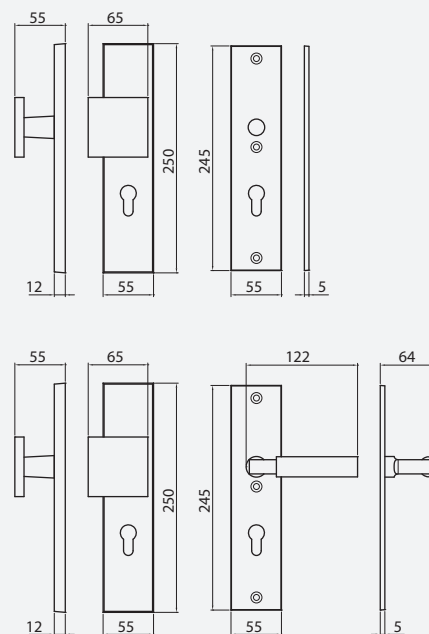

	OCS M18	OCL M4	ONL M7	Conf. pz.
626 / 12 / 599 / 5 / 625 Q8 PZ72 S/MANIGLIA Guarnitura di sicurezza con pomolo senza maniglia <i>Security set with knob without handle</i>	R06260599980103 135,10	R06260599980107 139,30	R06260599980130 139,30	1
627 / 12 / 599 / 5 / 625 Q10 PZ92 S/MANIGLIA Guarnitura di sicurezza con pomolo senza maniglia <i>Security set with knob without handle</i>	R06270599902103 136,00	R06270599902107 140,20	R06270599902130 140,20	1
626 / 12 / 599 / 5 / 625 / 988 Q8 PZ72 C/MANIGLIA Guarnitura di sicurezza con pomolo + maniglia <i>Security set with knob + handle</i>	R06260599980903 162,40	R06260599980907 166,60	R06260599980930 166,60	1
627 / 12 / 599 / 5 / 625 / 988 Q10 PZ92 C/MANIGLIA Guarnitura di sicurezza con pomolo + maniglia <i>Security set with knob + handle</i>	R06270599902903 163,30	R06270599902907 167,50	R06270599902930 167,50	1



OLV-M1

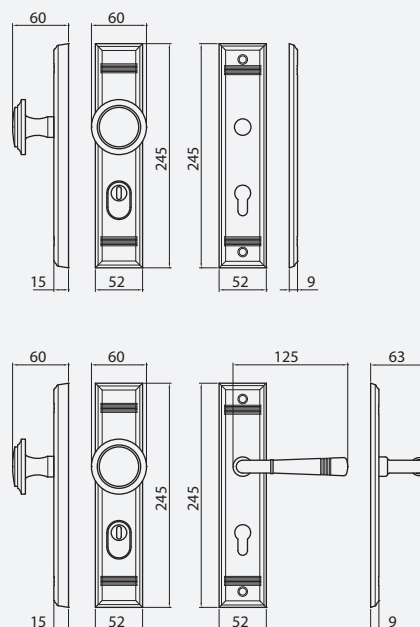

	OLV M1	OCL M4	ONS M9	OFA M69	Conf. pz.
322 / 15 / 305 / 9 / 57 Q8 KS72 S/MANIGLIA Guarnitura di sicurezza con pomolo senza maniglia	R03220305880201	R03220305880207	R03220305880227	R03220305880229	1
<i>Security set with knob without handle</i>	134,10	144,00	153,90	153,90	
322 / 15 / 305 / 9 / 57 / 716 Q8 KS72 C/MANIGLIA Guarnitura di sicurezza con pomolo + maniglia	R03220305880801	R03220305880807	R03220305880827	R03220305880829	1
<i>Security set with knob + handle</i>	147,30	157,20	168,00	168,00	



OLV-M1

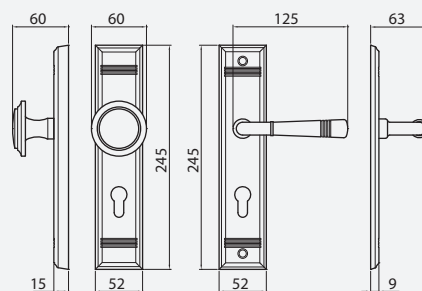
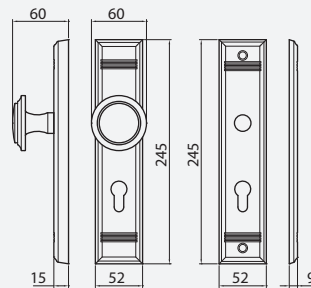

	OLV M1	OCL M4	ONS M9	OFA M69	Conf. pz.
322 / 15 / 305 / 9 / 57 Q8 PZ72 S/MANIGLIA Guarnitura di sicurezza con pomolo senza maniglia <i>Security set with knob without handle</i>	R03220305880101	R03220305880107	R03220305880127	R03220305880129	1
	113,00	122,80	132,70	132,70	
323 / 15 / 305 / 9 / 57 Q10 PZ92 S/MANIGLIA Guarnitura di sicurezza con pomolo senza maniglia <i>Security set with knob without handle</i>	R03230305802101	R03230305802107	R03230305802127	R03230305802129	1
	113,90	123,80	133,60	133,60	
322 / 15 / 305 / 9 / 57 / 716 Q8 PZ72 C/MANIGLIA Guarnitura di sicurezza con pomolo + maniglia <i>Security set with knob + handle</i>	R03220305880901	R03220305880907	R03220305880927	R03220305880929	1
	126,10	136,00	146,80	146,80	
323 / 15 / 305 / 9 / 57 / 716 Q10 PZ92 C/MANIGLIA Guarnitura di sicurezza con pomolo + maniglia <i>Security set with knob + handle</i>	R03230305802901	R03230305802907	R03230305802927	R03230305802929	1
	127,00	136,90	147,70	147,70	



OLV-M1

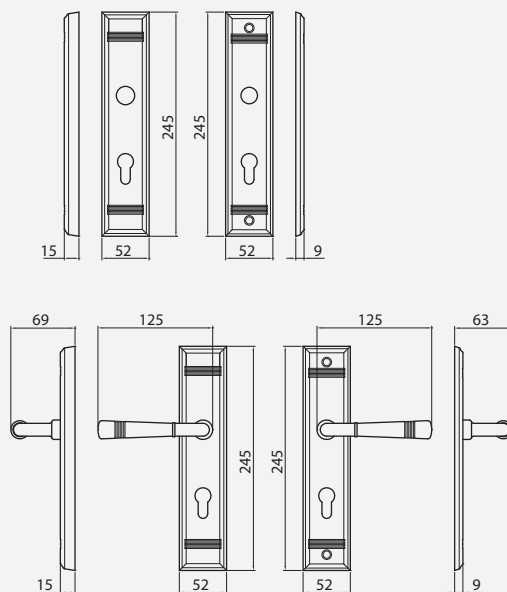

	OLV M1	OCL M4	ONS M9	OFA M69	Conf. pz.
326 / 15 / 305 / 9 / 716 Q8 PZ72 MAN+MAN Guarnitura di sicurezza con maniglia + maniglia <i>Security set with handle + handle</i>	R03260305780901	R03260305780907	R03260305780927	R03260305780929	1
	124,20	135,60	142,20	142,20	
327 / 15 / 305 / 9 / 716 Q10 PZ92 MAN+MAN Guarnitura di sicurezza con maniglia + maniglia <i>Security set with handle + handle</i>	R03270305702901	R03270305702907	R03270305702927	R03270305702929	1
	125,20	136,50	143,10	143,10	
326 / 15 / 305 / 9 PLACCHE PZ72 Guarnitura di sicurezza solo placche <i>Security set only plates</i>	R03260305790101	R03260305790107	R03260305790127	R03260305790129	1
	99,80	109,20	113,90	113,90	
327 / 15 / 305 / 9 PLACCHE PZ92 Guarnitura di sicurezza solo placche <i>Security set only plates</i>	R03270305792101	R03270305792107	R03260305790127	R03260305790129	1
	99,80	109,20	113,90	113,90	



OLV-M1

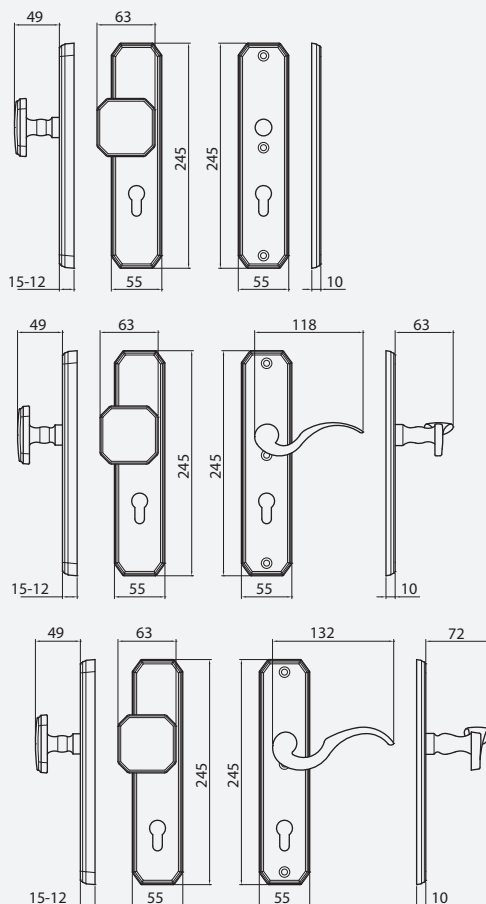

	OLV M1		OLV M1
412 / 12 / 400 / 10 / 412 DX Q8 PZ72 S/M Guarnitura di sicurezza con pomolo s/maniglia <i>Security set with knob without handle</i>	R412B0400380101 113,00	412 / 12 / 400 / 10 / 412 SX / 11 DX Q8 PZ72 C/M Guarnitura di sicurezza con pomolo + maniglia <i>Security set with knob + handle</i>	R412B0400480701 124,20
412 / 12 / 400 / 10 / 412 SX Q8 PZ72 S/M Guarnitura di sicurezza con pomolo s/maniglia <i>Security set with knob without handle</i>	R412B0400480101 113,00	412 / 12 / 400 / 10 / 412 DX / 11 SX Q8 PZ72 C/M Guarnitura di sicurezza con pomolo + maniglia <i>Security set with knob + handle</i>	R412B0400380901 124,20
412 / 15 / 400 / 10 / 412 DX Q8 PZ72 S/M Guarnitura di sicurezza con pomolo s/maniglia <i>Security set with knob without handle</i>	R412A0400380101 115,30	412 / 15 / 400 / 10 / 412 SX / 11 DX Q8 PZ72 C/M Guarnitura di sicurezza con pomolo + maniglia <i>Security set with knob + handle</i>	R412A0400480701 126,60
412 / 15 / 400 / 10 / 412 SX Q8 PZ72 S/M Guarnitura di sicurezza con pomolo s/maniglia <i>Security set with knob without handle</i>	R412A0400480101 115,30	412 / 15 / 400 / 10 / 412 DX / 11 SX Q8 PZ72 C/M Guarnitura di sicurezza con pomolo + maniglia <i>Security set with knob + handle</i>	R412A0400380901 126,60
415 / 12 / 400 / 10 / 412 DX Q10 PZ92 S/M Guarnitura di sicurezza con pomolo s/maniglia <i>Security set with knob without handle</i>	R415B0400302101 113,90	415 / 12 / 400 / 10 / 412 SX / 11H DX Q10 PZ92 C/M Guarnitura di sicurezza con pomolo + maniglia <i>Security set with knob + handle</i>	R415B0400402701 125,20
415 / 12 / 400 / 10 / 412 SX Q10 PZ92 S/M Guarnitura di sicurezza con pomolo s/maniglia <i>Security set with knob without handle</i>	R415B0400402101 113,90	415 / 12 / 400 / 10 / 412 DX / 11H SX Q10 PZ92 C/M Guarnitura di sicurezza con pomolo + maniglia <i>Security set with knob + handle</i>	R415B0400302901 125,20
415 / 15 / 400 / 10 / 412 DX Q10 PZ92 S/M Guarnitura di sicurezza con pomolo s/maniglia <i>Security set with knob without handle</i>	R415A0400302101 116,30	415 / 15 / 400 / 10 / 412 SX / 11H DX Q10 PZ92 C/M Guarnitura di sicurezza con pomolo + maniglia <i>Security set with knob + handle</i>	R415A0400402701 127,50
415 / 15 / 400 / 10 / 412 SX Q10 PZ92 S/M Guarnitura di sicurezza con pomolo s/maniglia <i>Security set with knob without handle</i>	R415A0400402101 116,30	415 / 15 / 400 / 10 / 412 DX / 11H SX Q10 PZ92 C/M Guarnitura di sicurezza con pomolo + maniglia <i>Security set with knob + handle</i>	R415A0400302901 127,50



OLV-M1

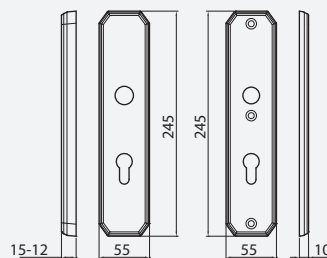
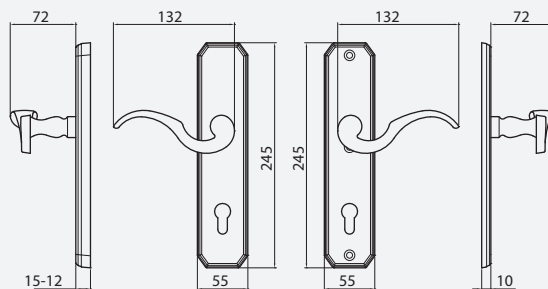
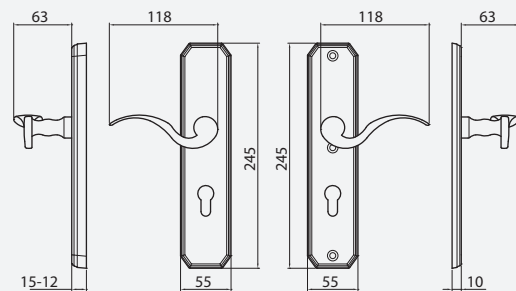

	OLV M1	Conf. pz.
404 / 12 / 400 / 10 / 11 Q8 PZ72 MAN+MAN Guarnitura di sicurezza con maniglia + maniglia <i>Security set with handle + handle</i>	R404B0400780901 115,30	1
404 / 15 / 400 / 10 / 11 Q8 PZ72 MAN+MAN Guarnitura di sicurezza con maniglia + maniglia <i>Security set with handle + handle</i>	R404A0400780901 117,60	1
406 / 12 / 400 / 10 / 11H Q10 PZ92 MAN+MAN Guarnitura di sicurezza con maniglia + maniglia <i>Security set with handle + handle</i>	R406B0400702901 116,30	1
406 / 15 / 400 / 10 / 11H Q10 PZ92 MAN+MAN Guarnitura di sicurezza con maniglia + maniglia <i>Security set with handle + handle</i>	R406A0400702901 118,60	1
404 / 12 / 400 / 10 PLACCHE PZ72 Guarnitura di sicurezza solo placche <i>Security set only plates</i>	R404B0400790101 92,70	1
404 / 15 / 400 / 10 PLACCHE PZ72 Guarnitura di sicurezza solo placche <i>Security set only plates</i>	R404A0400790101 95,10	1
406 / 12 / 400 / 10 PLACCHE PZ92 Guarnitura di sicurezza solo placche <i>Security set only plates</i>	R406B0400792101 92,70	1
406 / 15 / 400 / 10 PLACCHE PZ92 Guarnitura di sicurezza solo placche <i>Security set only plates</i>	R406A0400792101 95,10	1



OLV-M1

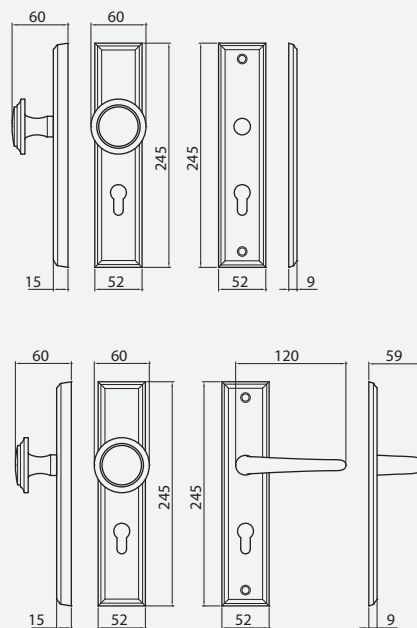

	OLV M1	OCL M4	Conf. pz.
312 / 15 / 301 / 9 / 57 Q8 PZ72 S/MANIGLIA Guarnitura di sicurezza con pomolo senza maniglia <i>Security set with knob without handle</i>	R03120301880101 105,90	R03120301880107 115,30	1
315 / 15 / 301 / 9 / 57 Q10 PZ92 S/MANIGLIA Guarnitura di sicurezza con pomolo senza maniglia <i>Security set with knob without handle</i>	R03150301802101 106,80	R03150301802107 116,30	1
312 / 15 / 301 / 9 / 57 / 50 Q8 PZ72 C/MANIGLIA Guarnitura di sicurezza con pomolo + maniglia <i>Security set with knob + handle</i>	R03120301880901 119,50	R03120301880907 129,40	1
315 / 15 / 301 / 9 / 57 / 50 Q10 PZ92 C/MANIGLIA Guarnitura di sicurezza con pomolo + maniglia <i>Security set with knob + handle</i>	R03150301802901 120,50	R03150301802907 130,30	1



OLV-M1

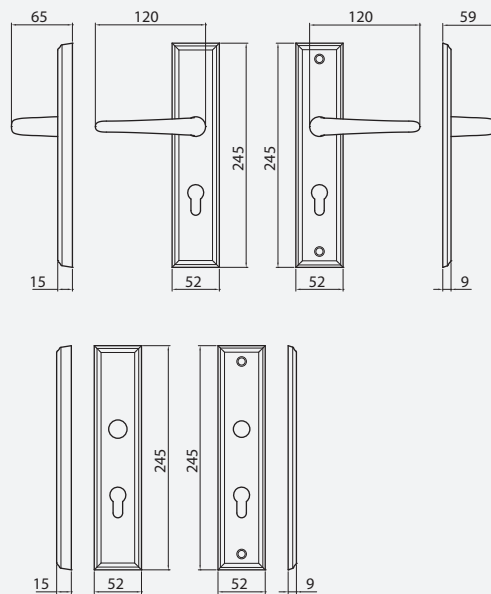

	OLV M1	OCL M4	Conf. pz.
304 / 15 / 301 / 9 / 50 Q8 PZ72 MAN+MAN Guarnitura di sicurezza con maniglia + maniglia <i>Security set with handle + handle</i>	R03040301780901	R03040301780907	1
	101,30	111,10	
306 / 15 / 301 / 9 / 50 Q10 PZ92 MAN+MAN Guarnitura di sicurezza con maniglia + maniglia <i>Security set with handle + handle</i>	R03060301702901	R03060301702907	1
	102,20	112,00	
304 / 15 / 301 / 9 PLACCHE PZ72 Guarnitura di sicurezza solo placche <i>Security set only plates</i>	R03040301790101	R03040301790107	1
	73,90	83,30	
306 / 15 / 301 / 9 PLACCHE PZ92 Guarnitura di sicurezza solo placche <i>Security set only plates</i>	R03060301792101	R03060301792107	1
	73,90	83,30	



OCS-M18

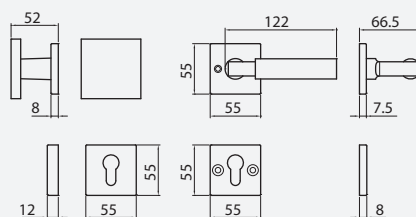

	OCS M18	OCL M4	ONS M9	ONL M7	Conf. pz.
988 DX / 539 - 565 / 564 Q8 / Q10 RB PZ VV Guarnitura di sicurezza con pomolo + maniglia Security set with knob + handle	R09880539504003	R09880539504007	R09880539504027	R09880539504030	1
	169,40	169,40	174,10	169,40	
988 SX / 539 - 565 / 564 Q8 / Q10 RB PZ VV Guarnitura di sicurezza con pomolo + maniglia Security set with knob + handle	R09880539507003	R09880539507007	R09880539507027	R09880539507030	1
	169,40	169,40	174,10	169,40	

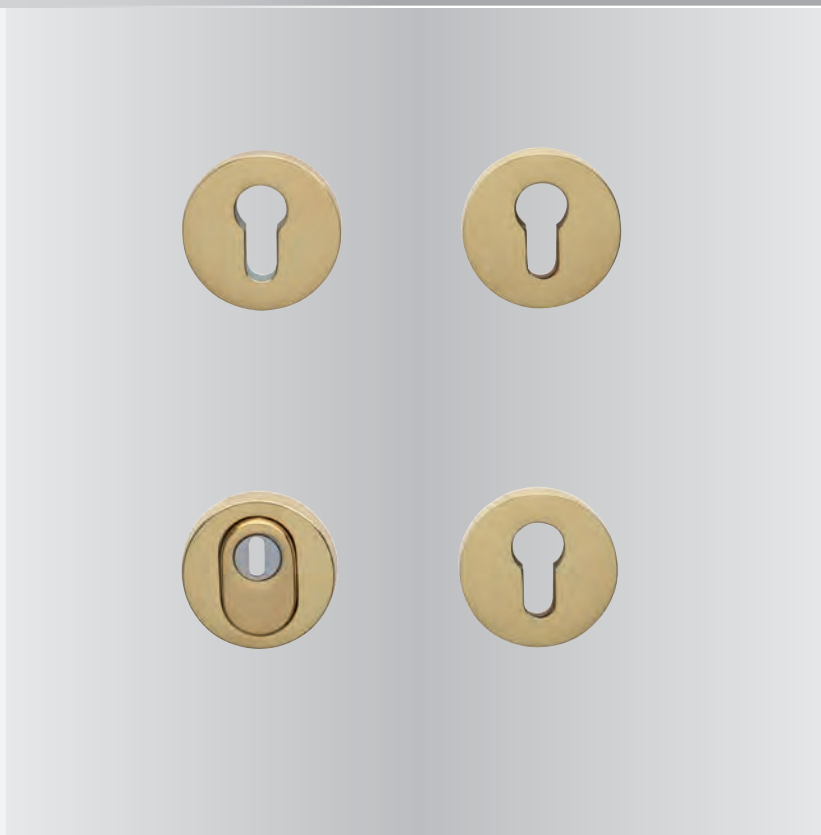

OLV-M1

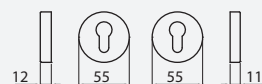

	OLV M1	OCS M18	OCL M4	ONS M9	Conf. pz.
519 / 509 PZ Bocchette di sicurezza <i>Security roses</i>	R051905095001	R051905095003	R051905095007	R051905095027	1
	48,90	54,00	54,00	56,70	
K 519 / 509 KS Bocchette di sicurezza <i>Security roses</i>	R051905096001	R051905096003	R051905096007	R051905096027	1
	76,80	80,20	80,20	84,20	

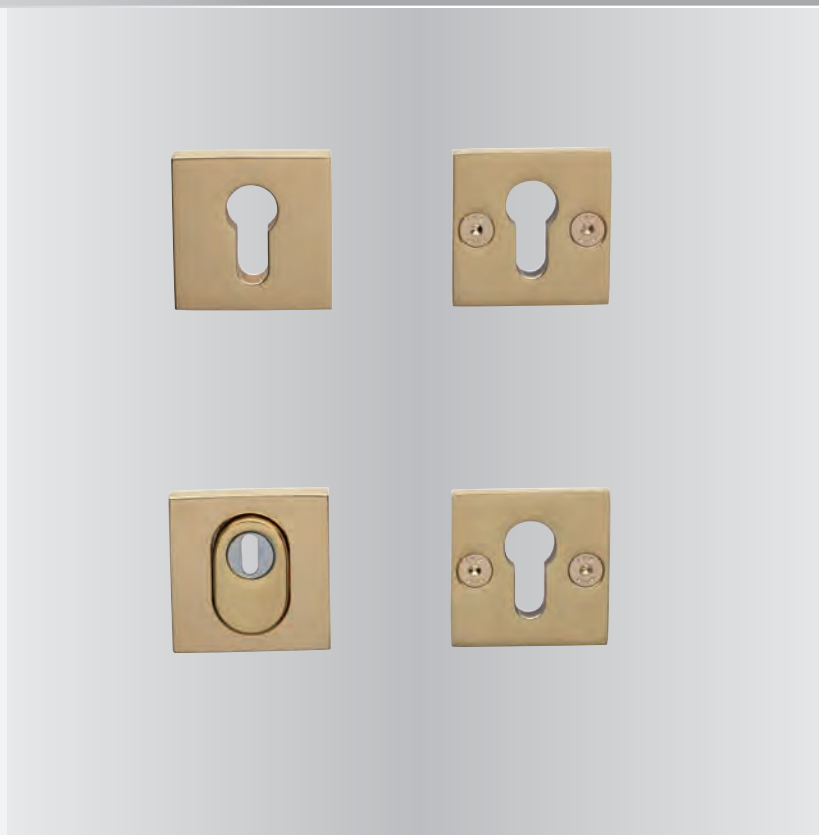

OLV-M1

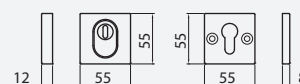
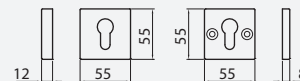

	OLV M1	OCS M18	OCL M4	ONS M9	Conf. pz.
565 / 564 PZ	R056505645001	R056505645003	R056505645007	R056505645027	1
Bocchette di sicurezza	45,90	51,10	51,10	52,50	
<i>Security roses</i>					
K 565 / 564 KS	R056505646001	R056505646003	R056505646007	R056505646027	1
Bocchette di sicurezza	74,20	79,80	79,80	81,70	
<i>Security roses</i>					



GHIDINI ALUMINIUM

MANIGLIE		ROSETTE - ROSES		CREMONESI-MARTELLINE-DK	
DOOR HANDLES		ROSETTE OVALI	350	WINDOW HANDELS	
		ROSETTE QUADRATE	348	DK 4008	368
10	304			DK 4038	368
23	306	ROSETTE TONDE	348	DK BRIXIA	365
138	308		349	DK GABRY	366
141	310	NOTTOLINI WC	351	DK ITACA-2005	366
142	312	PLACCHE - PLATES		DK KEY	369
143	314	B	352	DK PELOPE-1000	365
144	316	B1	352	DK ROOF	369
190	318	B2	353	DK SEVEN	364
220	320	C	353	DK UNIVERSAL	367
239	322	CH	354	DK VIENNA	367
240	324	E	354	GIOCHI PER CREMONESI	362
260	326	FO24/32/40	360	MARTELLINA 2010	363
1050	330	FR24/40	361	MARTELLINA 2013	363
2027	334	I	355	MARTELLINA 3013	363
2071	347	LATCH	359	MARTELLINA UNIVERSALE	362
2100	336	LOCK	359		
BRIXIA	294	P	355	GUARNITURE SPECIALI - POMOLI	
CRONO	338	S2	356	SPECIAL COMBINATIONS - KNOBS	
CUORE-2006	347	S4	356	JOLLY-210 + POMOLO 7071 SU PLACCA I	370
DAFNE	296	TB	357	POMOLO 7071 SU PLACCA I	370
ERIKA	346	TF2	357	POMOLO CUORE-7000 SU PLACCA B	371
EUROPA-238	340	TF4	358	JOLLY-210 + PALLIERE 6006 SU PLACCA TF2	372
GABRY	342	V	358	JOLLY-210 + PALLIERE 6007 SU PLACCA TF2	372
ITACA-2005	332	X	359	POMOLO 7071 FISSO	373
JOLLY-210	344			POMOLO 7009 FISSO	373
MEDEA	298				
MIGNON	346	KIT DI SICUREZZA PLACCA RETTANGOLARE		KIT DI SICUREZZA PLACCA OVALE	
PELOPE-1000	328	SECURITY KITS ON RECTANGULAR PLATE		SECURITY KITS ON OVAL PLATE	
PIGNA-2008	302	JOLLY-210	382-383	143	374-375
SEVEN	288	220	384-385	239	378-379-381
SEVEN Q	286	KIT SENZA MANIGLIA	381	2004	380
SUSY-2040	290			EUROPA-238	376-377
UNIVERSAL	300	ARTICOLI VARI-MISCELLANEOUS ARTICLES			
UNO	292	MANIGLIETTA 6008	386		
VIENNA	346	MANIGLIETTA 6010	386		



F1

1

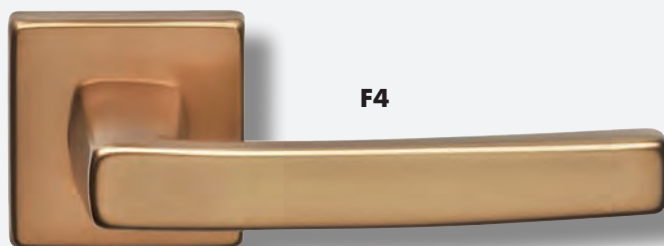
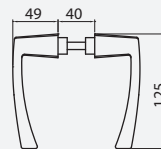

F4

2

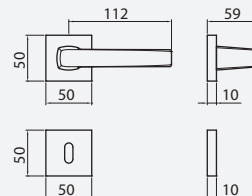

F9

3

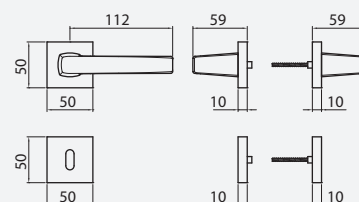

4

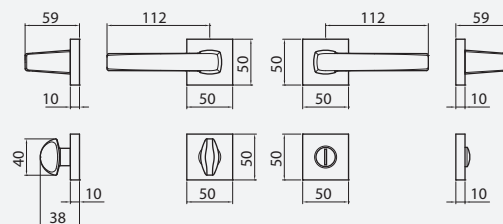

5

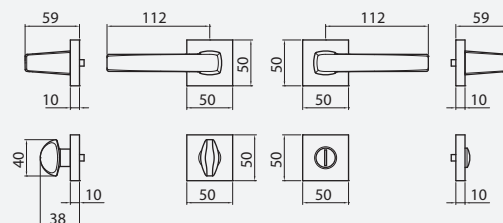

Finiture disponibili a richiesta:
 Available finishings on request:

Bianco/White RAL 9010
 Nero/Black RAL 9005 Lucido/Bright
 Nero/Black RAL 9005 Opaco/Matt

Martellina DK a pag.364
 Window handle pag.364

1	F1	F2	F3	F4	€	Conf. pz.	F9	€	Conf. pz.
Q8 BIL	77470208001	77470208002	77470208003	77470208004	6,70	10	77470208009	7,70	10
	7747020800150	7747020800250	7747020800350	7747020800450	6,50	50	7747020800950	7,50	50
2									
Q8 RQ 50	77470210301	77470210302	77470210303	77470210304	9,25	10	77470210309	10,65	10
	7747021030150	7747021030250	7747021030350	7747021030450	9,05	50	7747021030950	10,45	50
Q8 RBQ 50	77470211301	77470211302	77470211303	77470211304	12,45	10	77470211309	14,30	10
	7747021130150	7747021130250	7747021130350	7747021130450	12,25	50	7747021130950	14,10	50
Q8 RBQY 50	77470215301	77470215302	77470215303	77470215304	12,45	10	77470215309	14,30	10
	7747021530150	7747021530250	7747021530350	7747021530450	12,25	50	7747021530950	14,10	50
3									
Q8 RQ 50 C/B	77470260301	77470260302	77470260303	77470260304	9,25	10	77470260309	10,65	10
	7747026030150	7747026030250	7747026030350	7747026030450	9,05	50	7747026030950	10,45	50
Q8 RBQ 50 C/B	77470261301	77470261302	77470261303	77470261304	12,45	10	77470261309	14,30	10
	7747026130150	7747026130250	7747026130350	7747026130450	12,25	50	7747026130950	14,10	50
Q8 RBQY 50 C/B	77470265301	77470265302	77470265303	77470265304	12,45	10	77470265309	14,30	10
	7747026530150	7747026530250	7747026530350	7747026530450	12,25	50	7747026530950	14,10	50
4									
Q8 RBQWC Q6 50	77470218001	77470218002	77470218003	77470218004	16,20	10	77470218009	18,60	10
	7747021800150	7747021800250	7747021800350	7747021800450	16,00	50	7747021800950	18,40	50
Q8 RBQWC Q8 50	77470218801	77470218802	77470218803	77470218804	16,20	10	77470218809	18,60	10
	7747021880150	7747021880250	7747021880350	7747021880450	16,00	50	7747021880950	18,40	50
5									
Q8 RBQWC Q6 50 C/B	77470268001	77470268002	77470268003	77470268004	16,20	10	77470268009	18,60	10
	7747026800150	7747026800250	7747026800350	7747026800450	16,00	50	7747026800950	18,40	50
Q8 RBQWC Q8 50 C/B	77470268801	77470268802	77470268803	77470268804	16,20	10	77470268809	18,60	10
	7747026880150	7747026880250	7747026880350	7747026880450	16,00	50	7747026880950	18,40	50



F1

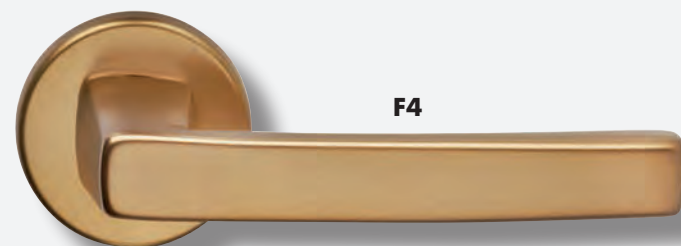

F4



F9

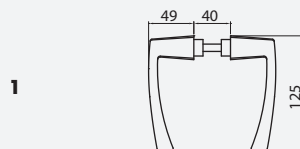

1

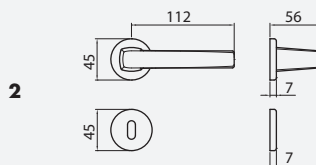

2

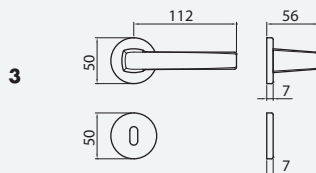

3

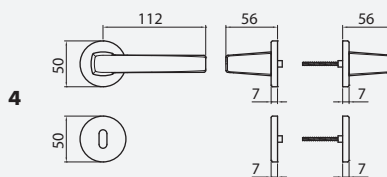

4

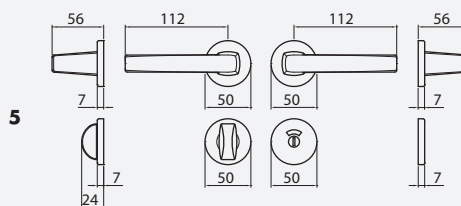

5

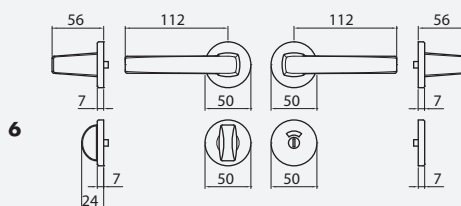

6

Finiture disponibili a richiesta:
 Available finishings on request:

Bianco/White RAL 9010
 Nero/Black RAL 9005 Lucido/Bright
 Nero/Black RAL 9005 Opaco/Matt

Martellina DK a pag.364
 Window handle pag.364

SEVEN

1	F1	F2	F3	F4	€	Conf. pz.	F9	€	Conf. pz.
Q8 BIL	77470208001	77470208002	77470208003	77470208004	6,70	10	77470208009	7,70	10
	7747020800150	7747020800250	7747020800350	7747020800450	6,50	50	7747020800950	7,50	50
2									
Q8 R 45	77470280001	77470280002	77470280003	77470280004	8,15	10	77470280009	9,40	10
	7747028000150	7747028000250	7747028000350	7747028000450	7,95	50	7747028000950	9,20	50
Q8 RB 45	77470281001	77470281002	77470281003	77470281004	9,60	10	77470281009	11,05	10
	7747028100150	7747028100250	7747028100350	7747028100450	9,40	50	7747028100950	10,85	50
Q8 RBY 45	77470285001	77470285002	77470285003	77470285004	9,60	10	77470285009	11,05	10
	7747028500150	7747028500250	7747028500350	7747028500450	9,40	50	7747028500950	10,85	50
3									
Q8 R 50	77470230001	77470230002	77470230003	77470230004	8,25	10	77470230009	9,50	10
	7747023000150	7747023000250	7747023000350	7747023000450	8,05	50	7747023000950	9,30	50
Q8 RB 50	77470231001	77470231002	77470231003	77470231004	9,80	10	77470231009	11,30	10
	7747023100150	7747023100250	7747023100350	7747023100450	9,60	50	7747023100950	11,10	50
Q8 RBB 50	77470231701	77470231702	77470231703	77470231704	9,80	10	77470231709	11,30	10
	7747023170150	7747023170250	7747023170350	7747023170450	9,60	50	7747023170950	11,10	50
Q8 RBY 50	77470235001	77470235002	77470235003	77470235004	9,80	10	77470235009	11,30	10
	7747023500150	7747023500250	7747023500350	7747023500450	9,60	50	7747023500950	11,10	50
4									
Q8 R 50 C/B	77470250501	77470250502	77470250503	77470250504	8,25	10	77470250509	9,50	10
	7747025050150	7747025050250	7747025050350	7747025050450	8,05	50	7747025050950	9,30	50
Q8 RB 50 C/B	77470251501	77470251502	77470251503	77470251504	9,80	10	77470251509	11,30	10
	7747025150150	7747025150250	7747025150350	7747025150450	9,60	50	7747025150950	11,10	50
Q8 RBB 50 C/B	77470251701	77470251702	77470251703	77470251704	9,80	10	77470251709	11,30	10
	7747025170150	7747025170250	7747025170350	7747025170450	9,60	50	7747025170950	11,10	50
Q8 RBY 50 C/B	77470255501	77470255502	77470255503	77470255504	9,80	10	77470255509	11,30	10
	7747025550150	7747025550250	7747025550350	7747025550450	9,60	50	7747025550950	11,10	50
5									
Q8 RBWC Q6 50	77470238001	77470238002	77470238003	77470238004	12,80	10	77470238009	14,70	10
	7747023800150	7747023800250	7747023800350	7747023800450	12,60	50	7747023800950	14,50	50
Q8 RBWC Q8 50	77470238801	77470238802	77470238803	77470238804	12,80	10	77470238809	14,70	10
	7747023880150	7747023880250	7747023880350	7747023880450	12,60	50	7747023880950	14,50	50
6									
Q8 RBWC Q6 50 C/B	77470258001	77470258002	77470258003	77470258004	12,80	10	77470258009	14,70	10
	7747025800150	7747025800250	7747025800350	7747025800450	12,60	50	7747025800950	14,50	50
Q8 RBWC Q8 50 C/B	77470258801	77470258802	77470258803	77470258804	12,80	10	77470258809	14,70	10
	7747025880150	7747025880250	7747025880350	7747025880450	12,60	50	7747025880950	14,50	50



F1



F4

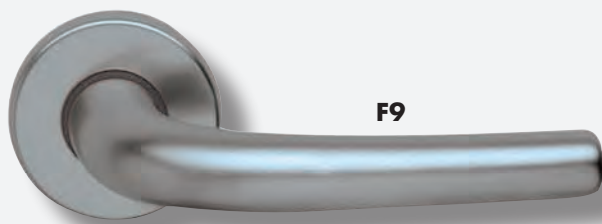

F9

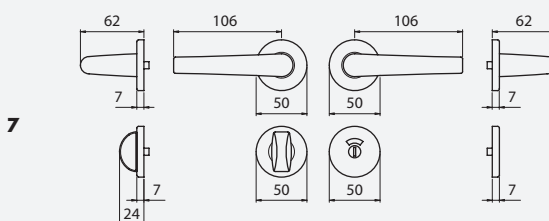
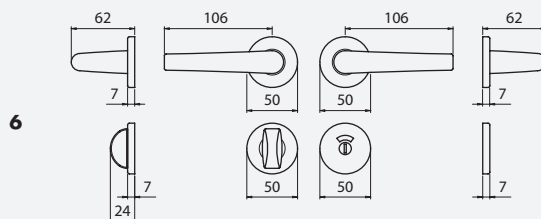
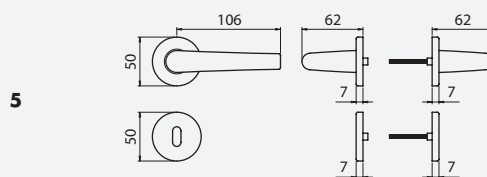
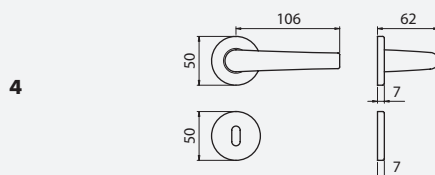
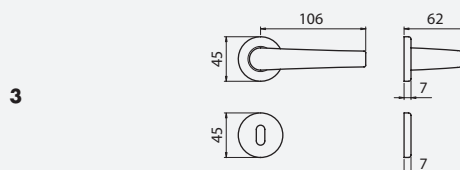
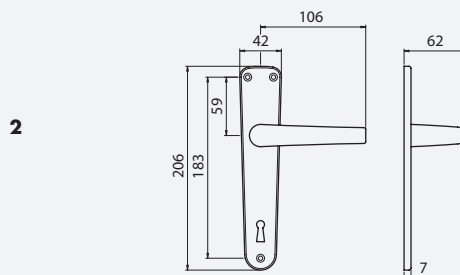
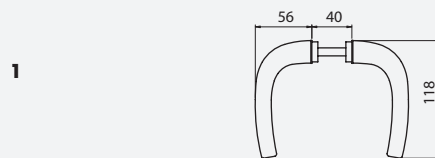

Finiture disponibili a richiesta:
 Available finishings on request:

Bianco/White RAL 9010
 Nero/Black RAL 9005 Lucido/Bright
 Nero/Black RAL 9005 Opaco/Matt

SUSY - 2040

1	F1	F2	F3	F4	€	Conf. pz.	F9	€	Conf. pz.
Q8 BIL	72040208001	72040208002	72040208003	72040208004	7,20	10	72040208009	8,30	10
	7204020800150	7204020800250	7204020800350	7204020800450	7,00	50	7204020800950	8,10	50
2									
Q8 P90	72040089001	72040089002	72040089003	72040089004	10,10	10	72040089009	11,60	10
	7204008900150	7204008900250	7204008900350	7204008900450	9,90	50	7204008900950	11,40	50
Q8 P70	72040087001	72040087002	72040087003	72040087004	10,10	10	72040087009	11,60	10
	7204008700150	7204008700250	7204008700350	7204008700450	9,90	50	7204008700950	11,40	50
Q8 PY85	72040088501	72040088502	72040088503	72040088504	10,10	10	72040088509	11,60	10
	7204008850150	7204008850250	7204008850350	7204008850450	9,90	50	7204008850950	11,40	50
3									
Q8 R 45	72040280001	72040280002	72040280003	72040280004	9,00	10	72040280009	10,40	10
	7204028000150	7204028000250	7204028000350	7204028000450	8,80	50	7204028000950	10,20	50
Q8 RB 45	72040281001	72040281002	72040281003	72040281004	10,80	10	72040281009	12,40	10
	7204028100150	7204028100250	7204028100350	7204028100450	10,60	50	7204028100950	12,30	50
Q8 RBY 45	72040285001	72040285002	72040285003	72040285004	10,80	10	72040285009	12,40	10
	7204028500150	7204028500250	7204028500350	7204028500450	10,60	50	7204028500950	12,30	50
4									
Q8 R 50	72040230001	72040230002	72040230003	72040230004	9,20	10	72040230009	10,60	10
	7204023000150	7204023000250	7204023000350	7204023000450	9,00	50	7204023000950	10,40	50
Q8 RB 50	72040231001	72040231002	72040231003	72040231004	11,20	10	72040231009	12,90	10
	7204023100150	7204023100250	7204023100350	7204023100450	11,00	50	7204023100950	12,70	50
Q8 RBB 50	72040231701	72040231702	72040231703	72040231704	11,20	10	72040231709	12,90	10
	7204023170150	7204023170250	7204023170350	7204023170450	11,00	50	7204023170950	12,70	50
Q8 RBY 50	72040235001	72040235002	72040235003	72040235004	11,20	10	72040235009	12,90	10
	7204023500150	7204023500250	7204023500350	7204023500450	11,00	50	7204023500950	12,70	50
5									
Q8 R 50 C/B	72040250501	72040250502	72040250503	72040250504	9,20	10	72040250509	10,60	10
	7204025050150	7204025050250	7204025050350	7204025050450	9,00	50	7204025050950	10,40	50
Q8 RB 50 C/B	72040251501	72040251502	72040251503	72040251504	11,20	10	72040251509	12,90	10
	7204025150150	7204025150250	7204025150350	7204025150450	11,00	50	7204025150950	12,70	50
Q8 RBB 50 C/B	72040251701	72040251702	72040251703	72040251704	11,20	10	72040251709	12,90	10
	7204025170150	7204025170250	7204025170350	7204025170450	11,00	50	7204025170950	12,70	50
Q8 RBY 50 C/B	72040255501	72040255502	72040255503	72040255504	11,20	10	72040255509	12,90	10
	7204025550150	7204025550250	7204025550350	7204025550450	11,00	50	7204025550950	12,70	50
6									
Q8 RBWC Q6 50	72040238001	72040238002	72040238003	72040238004	14,20	10	72040238009	16,40	10
	7204023800150	7204023800250	7204023800350	7204023800450	14,00	50	7204023800950	16,20	50
Q8 RBWC Q8 50	72040238801	72040238802	72040238803	72040238804	14,20	10	72040238809	16,40	10
	7204023880150	7204023880250	7204023880350	7204023880450	14,00	50	7204023880950	16,20	50
7									
Q8 RBWC Q6 50 C/B	72040258001	72040258002	72040258003	72040258004	15,10	10	72040258009	17,40	10
	7204025800150	7204025800250	7204025800350	7204025800450	14,90	50	7204025800950	17,20	50
Q8 RBWC Q8 50 C/B	72040258801	72040258802	72040258803	72040258804	15,10	10	72040258809	17,40	10
	7204025880150	7204025880250	7204025880350	7204025880450	14,90	50	7204025880950	17,20	50



F1

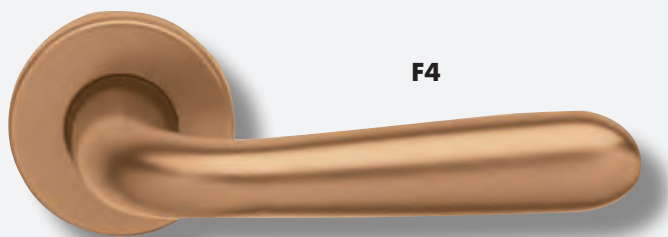
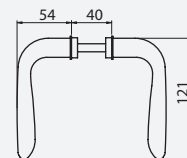

F4

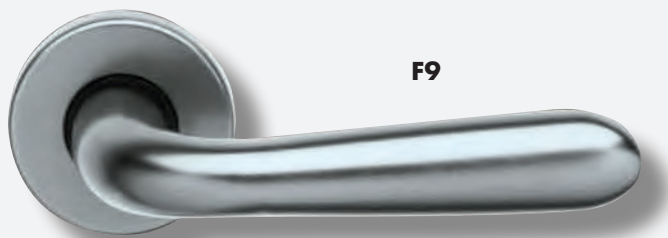
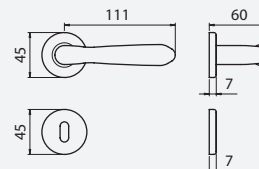

F9

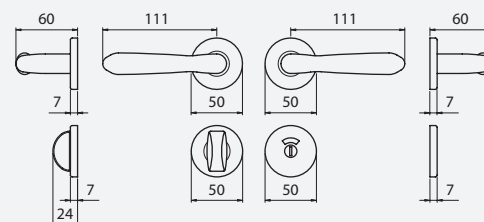
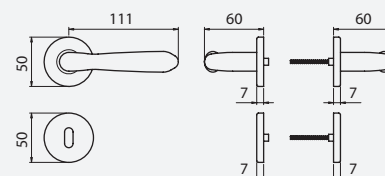
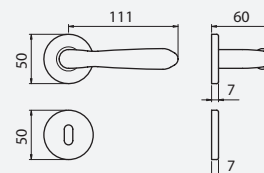

Finiture disponibili a richiesta:
Available finishings on request:

Bianco/White RAL 9010
Nero/Black RAL 9005 Lucido/Bright
Nero/Black RAL 9005 Opaco/Matt

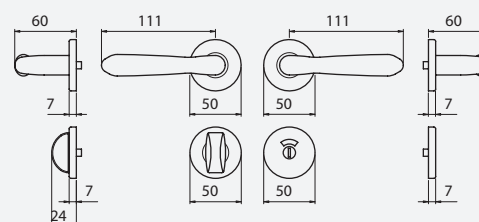

1	F1	F2	F3	F4	€	Conf. pz.	F9	€	Conf. pz.
Q8 BIL	77796208001	77796208002	77796208003	77796208004	8,20	10	77796208009	9,50	10
	7779620800150	7779620800250	7779620800350	7779620800450	8,00	50	7779620800950	9,30	50
2									
Q8 R 45	77796280001	77796280002	77796280003	77796280004	10,00	10	77796280009	11,60	10
	7779628000150	7779628000250	7779628000350	7779628000450	9,80	50	7779628000950	11,30	50
Q8 RB 45	77796281001	77796281002	77796281003	77796281004	11,80	10	77796281009	13,60	10
	7779628100150	7779628100250	7779628100350	7779628100450	11,60	50	7779628100950	13,40	50
Q8 RBY 45	77796285001	77796285002	77796285003	77796285004	11,80	10	77796285009	13,60	10
	7779628500150	7779628500250	7779628500350	7779628500450	11,60	50	7779628500950	13,40	50
3									
Q8 R 50	77796230001	77796230002	77796230003	77796230004	10,20	10	77796230009	11,80	10
	7779623000150	7779623000250	7779623000350	7779623000450	10,00	50	7779623000950	11,60	50
Q8 RB 50	77796231001	77796231002	77796231003	77796231004	12,20	10	77796231009	14,10	10
	7779623100150	7779623100250	7779623100350	7779623100450	12,00	50	7779623100950	13,90	50
Q8 RBB 50	77796231701	77796231702	77796231703	77796231704	12,20	10	77796231709	14,10	10
	7779623170150	7779623170250	7779623170350	7779623170450	12,00	50	7779623170950	13,90	50
Q8 RBY 50	77796235001	77796235002	77796235003	77796235004	12,20	10	77796235009	14,10	10
	7779623500150	7779623500250	7779623500350	7779623500450	12,00	50	7779623500950	13,90	50
4									
Q8 R 50 C/B	77796250501	77796250502	77796250503	77796250504	10,20	10	77796250509	11,80	10
	7779625050150	7779625050250	7779625050350	7779625050450	10,00	50	7779625050950	11,60	50
Q8 RB 50 C/B	77796251501	77796251502	77796251503	77796251504	12,20	10	77796251509	14,10	10
	7779625150150	7779625150250	7779625150350	7779625150450	12,00	50	7779625150950	13,90	50
Q8 RBB 50 C/B	77796251701	77796251702	77796251703	77796251704	12,20	10	77796251709	14,10	10
	7779625170150	7779625170250	7779625170350	7779625170450	12,00	50	7779625170950	13,90	50
Q8 RBY 50 C/B	77796255501	77796255502	77796255503	77796255504	12,20	10	77796255509	14,10	10
	7779625550150	7779625550250	7779625550350	7779625550450	12,00	50	7779625550950	13,90	50
5									
Q8 RBWC Q6 50	77796238001	77796238002	77796238003	77796238004	15,20	10	77796238009	17,50	10
	7779623800150	7779623800250	7779623800350	7779623800450	15,00	50	7779623800950	17,30	50
Q8 RBWC Q8 50	77796238801	77796238802	77796238803	77796238804	15,20	10	77796238809	17,50	10
	7779623880150	7779623880250	7779623880350	7779623880450	15,00	50	7779623880950	17,30	50
6									
Q8 RBWC Q6 50 C/B	77796258001	77796258002	77796258003	77796258004	16,10	10	77796258009	18,50	10
	7779625800150	7779625800250	7779625800350	7779625800450	15,90	50	7779625800950	18,30	50
Q8 RBWC Q8 50 C/B	77796258801	77796258802	77796258803	77796258804	16,10	10	77796258809	18,50	10
	7779625880150	7779625880250	7779625880350	7779625880450	15,90	50	7779625880950	18,30	50



F1



F4



F9

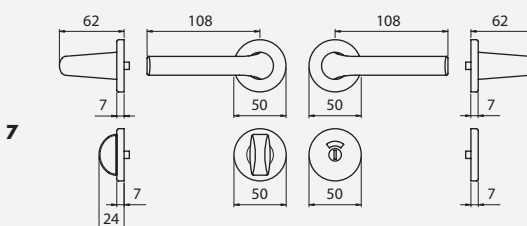
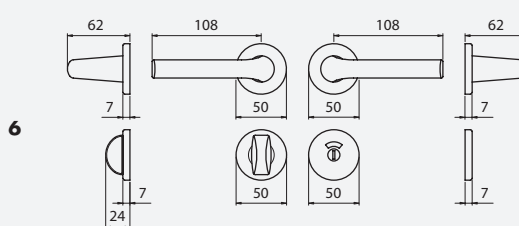
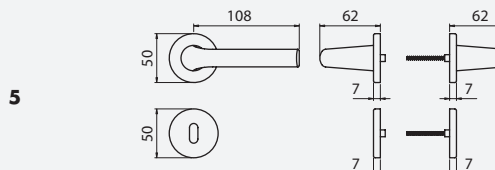
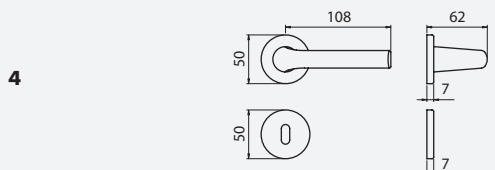
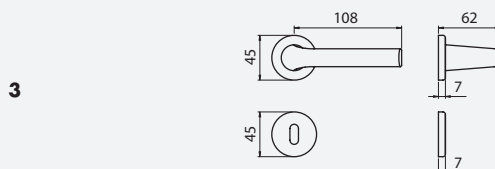
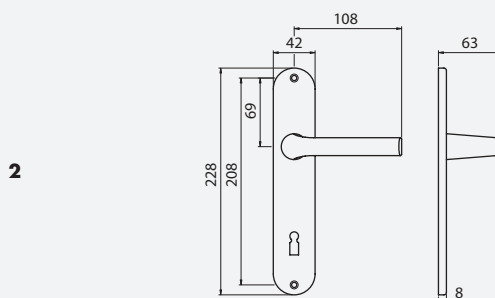
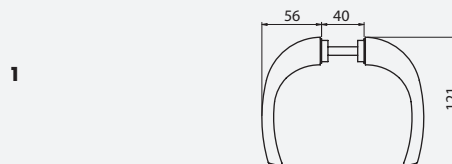

Finiture disponibili a richiesta:
 Available finishings on request:

Bianco/White RAL 9010
 Nero/Black RAL 9005 Lucido/Bright
 Nero/Black RAL 9005 Opaco/Matt

Martellina DK a pag.365
 Window handle pag.365

	F1	F2	F3	F4	€	Conf. pz.	F9	€	Conf. pz.
1 Q8 BIL	77438208001	77438208002	77438208003	77438208004	8,00	10	77438208009	9,30	10
	7743820800150	7743820800250	7743820800350	7743820800450	7,80	50	7743820800950	9,10	50
2 Q8 P90	77438089001	77438089002	77438089003	77438089004	11,10	10	77438089009	12,80	10
	7743808900150	7743808900250	7743808900350	7743808900450	10,90	50	7743808900950	12,60	50
Q8 P70	77438087001	77438087002	77438087003	77438087004	11,10	10	77438087009	12,80	10
	7743808700150	7743808700250	7743808700350	7743808700450	10,90	50	7743808700950	12,60	50
Q8 PY85	77438088501	77438088502	77438088503	77438088504	11,10	10	77438088509	12,80	10
	7743808850150	7743808850250	7743808850350	7743808850450	10,90	50	7743808850950	12,60	50
3 Q8 R 45	77438280001	77438280002	77438280003	77438280004	9,80	10	77438280009	11,30	10
	7743828000150	7743828000250	7743828000350	7743828000450	9,60	50	7743828000950	11,10	50
Q8 RB 45	77438281001	77438281002	77438281003	77438281004	11,60	10	77438281009	13,40	10
	7743828100150	7743828100250	7743828100350	7743828100450	11,40	50	7743828100950	13,20	50
Q8 RBY 45	77438285001	77438285002	77438285003	77438285004	11,60	10	77438285009	13,40	10
	7743828500150	7743828500250	7743828500350	7743828500450	11,40	50	7743828500950	13,20	50
4 Q8 R 50	77438230001	77438230002	77438230003	77438230004	10,00	10	77438230009	11,60	10
	7743823000150	7743823000250	7743823000350	7743823000450	9,80	50	7743823000950	11,30	50
Q8 RB 50	77438231001	77438231002	77438231003	77438231004	12,00	10	77438231009	13,90	10
	7743823100150	7743823100250	7743823100350	7743823100450	11,80	50	7743823100950	13,70	50
Q8 RBB 50	77438231701	77438231702	77438231703	77438231704	12,00	10	77438231709	13,90	10
	7743823170150	7743823170250	7743823170350	7743823170450	11,80	50	7743823170950	13,70	50
Q8 RBY 50	77438235001	77438235002	77438235003	77438235004	12,00	10	77438235009	13,90	10
	7743823500150	7743823500250	7743823500350	7743823500450	11,80	50	7743823500950	13,70	50
5 Q8 R 50 C/B	77438250501	77438250502	77438250503	77438250504	10,00	10	77438250509	11,60	10
	7743825050150	7743825050250	7743825050350	7743825050450	9,80	50	7743825050950	11,30	50
Q8 RB 50 C/B	77438251501	77438251502	77438251503	77438251504	12,00	10	77438251509	13,90	10
	7743825150150	7743825150250	7743825150350	7743825150450	11,80	50	7743825150950	13,70	50
Q8 RBB 50 C/B	77438251701	77438251702	77438251703	77438251704	12,00	10	77438251709	13,90	10
	7743825170150	7743825170250	7743825170350	7743825170450	11,80	50	7743825170950	13,70	50
Q8 RBY 50 C/B	77438255501	77438255502	77438255503	77438255504	12,00	10	77438255509	13,90	10
	7743825550150	7743825550250	7743825550350	7743825550450	11,80	50	7743825550950	13,70	50
6 Q8 RBWC Q6 50	77438238001	77438238002	77438238003	77438238004	15,00	10	77438238009	17,20	10
	7743823800150	7743823800250	7743823800350	7743823800450	14,80	50	7743823800950	17,00	50
Q8 RBWC Q8 50	77438238801	77438238802	77438238803	77438238804	15,00	10	77438238809	17,20	10
	7743823880150	7743823880250	7743823880350	7743823880450	14,80	50	7743823880950	17,00	50
7 Q8 RBWC Q6 50 C/B	77438258001	77438258002	77438258003	77438258004	15,90	10	77438258009	18,30	10
	7743825800150	7743825800250	7743825800350	7743825800450	15,70	50	7743825800950	18,10	50
Q8 RBWC Q8 50 C/B	77438258801	77438258802	77438258803	77438258804	15,90	10	77438258809	18,30	10
	7743825880150	7743825880250	7743825880350	7743825880450	15,70	50	7743825880950	18,10	50

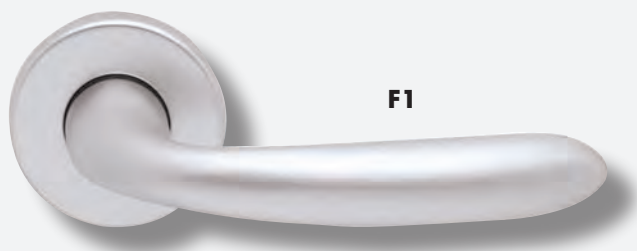

F1

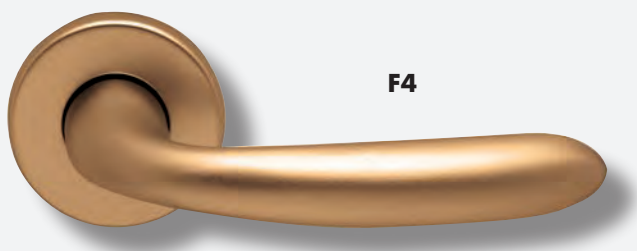

F4

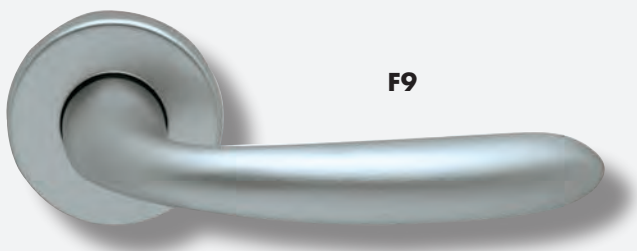

F9

1

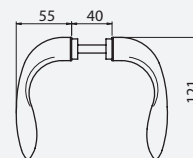

2

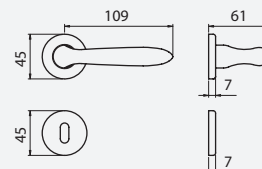

3

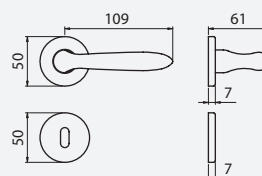

4

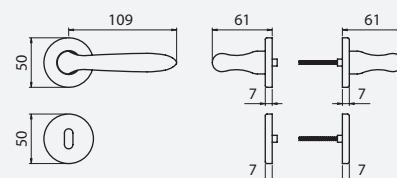

5

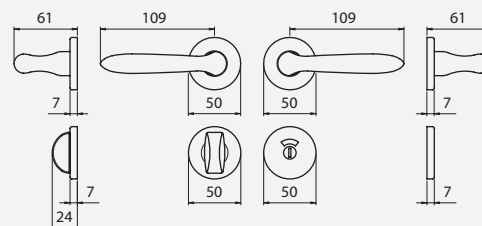

6

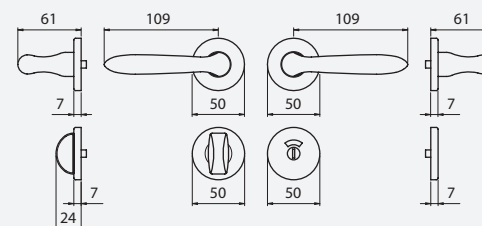

Finiture disponibili a richiesta:
 Available finishings on request:

Bianco/White RAL 9010
 Nero/Black RAL 9005 Lucido/Bright
 Nero/Black RAL 9005 Opaco/Matt

1	F1	F2	F3	F4	€	Conf. pz.	F9	€	Conf. pz.
Q8 BIL	77436208001	77436208002	77436208003	77436208004	8,20	10	77436208009	9,50	10
	7743620800150	7743620800250	7743620800350	7743620800450	8,00	50	7743620800950	9,30	50
2									
Q8 R 45	77436280001	77436280002	77436280003	77436280004	10,00	10	77436280009	11,60	10
	7743628000150	7743628000250	7743628000350	7743628000450	9,80	50	7743628000950	11,30	50
Q8 RB 45	77436281001	77436281002	77436281003	77436281004	11,80	10	77436281009	13,60	10
	7743628100150	7743628100250	7743628100350	7743628100450	11,60	50	7743628100950	13,40	50
Q8 RBY 45	77436285001	77436285002	77436285003	77436285004	11,80	10	77436285009	13,60	10
	7743628500150	7743628500250	7743628500350	7743628500450	11,60	50	7743628500950	13,40	50
3									
Q8 R 50	77436230001	77436230002	77436230003	77436230004	10,20	10	77436230009	11,80	10
	7743623000150	7743623000250	7743623000350	7743623000450	10,00	50	7743623000950	11,60	50
Q8 RB 50	77436231001	77436231002	77436231003	77436231004	12,20	10	77436231009	14,10	10
	7743623100150	7743623100250	7743623100350	7743623100450	12,00	50	7743623100950	13,90	50
Q8 RBB 50	77436231701	77436231702	77436231703	77436231704	12,20	10	77436231709	14,10	10
	7743623170150	7743623170250	7743623170350	7743623170450	12,00	50	7743623170950	13,90	50
Q8 RBY 50	77436235001	77436235002	77436235003	77436235004	12,20	10	77436235009	14,10	10
	7743623500150	7743623500250	7743623500350	7743623500450	12,00	50	7743623500950	13,90	50
4									
Q8 R 50 C/B	77436250501	77436250502	77436250503	77436250504	10,20	10	77436250509	11,80	10
	7743625050150	7743625050250	7743625050350	7743625050450	10,00	50	7743625050950	11,60	50
Q8 RB 50 C/B	77436251501	77436251502	77436251503	77436251504	12,20	10	77436251509	14,10	10
	7743625150150	7743625150250	7743625150350	7743625150450	12,00	50	7743625150950	13,90	50
Q8 RBB 50 C/B	77436251701	77436251702	77436251703	77436251704	12,20	10	77436251709	14,10	10
	7743625170150	7743625170250	7743625170350	7743625170450	12,00	50	7743625170950	13,90	50
Q8 RBY 50 C/B	77436255501	77436255502	77436255503	77436255504	12,20	10	77436255509	14,10	10
	7743625550150	7743625550250	7743625550350	7743625550450	12,00	50	7743625550950	13,90	50
5									
Q8 RBWC Q6 50	77436238001	77436238002	77436238003	77436238004	15,20	10	77436238009	17,50	10
	7743623800150	7743623800250	7743623800350	7743623800450	15,00	50	7743623800950	17,30	50
Q8 RBWC Q8 50	77436238801	77436238802	77436238803	77436238804	15,20	10	77436238809	17,50	10
	7743623880150	7743623880250	7743623880350	7743623880450	15,00	50	7743623880950	17,30	50
6									
Q8 RBWC Q6 50 C/B	77436258001	77436258002	77436258003	77436258004	16,10	10	77436258009	18,50	10
	7743625800150	7743625800250	7743625800350	7743625800450	15,90	50	7743625800950	18,30	50
Q8 RBWC Q8 50 C/B	77436258801	77436258802	77436258803	77436258804	16,10	10	77436258809	18,50	10
	7743625880150	7743625880250	7743625880350	7743625880450	15,90	50	7743625880950	18,30	50

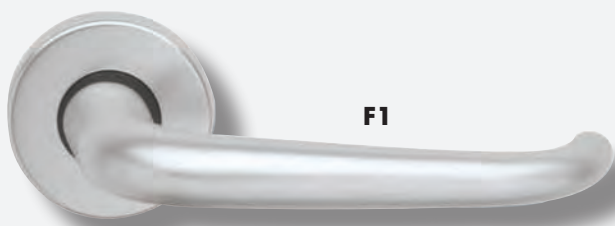

F1



F4



F9

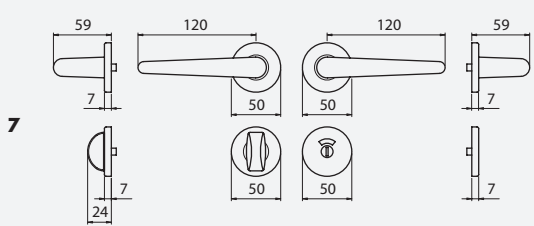
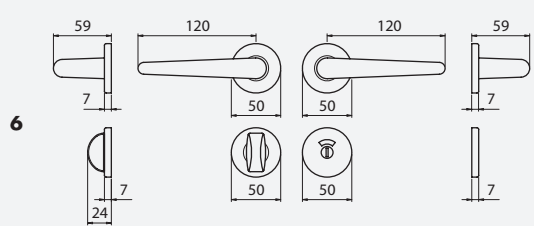
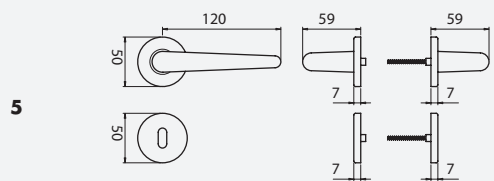
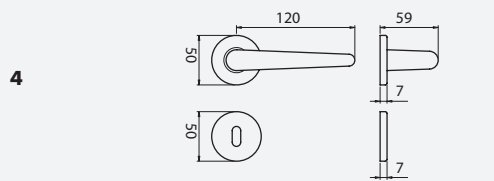
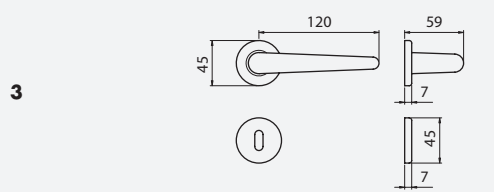
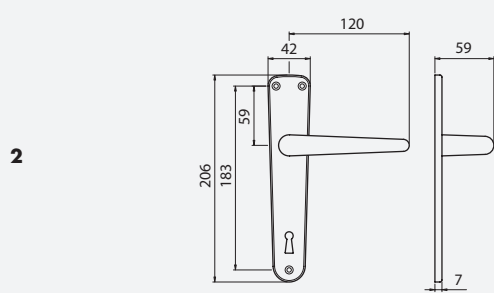
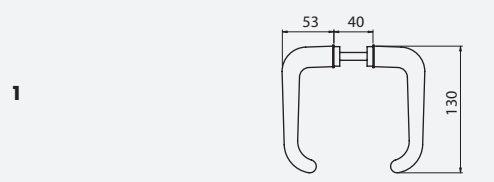

Finiture disponibili a richiesta:
 Available finishings on request:

Bianco/White RAL 9010
 Nero/Black RAL 9005 Lucido/Bright
 Nero/Black RAL 9005 Opaco/Matt

	F1	F2	F3	F4	€	Conf. pz.	F9	€	Conf. pz.
1									
Q8 BIL	77046208001	77046208002	77046208003	77046208004	7,70	10	77046208009	8,90	10
	7704620800150	7704620800250	7704620800350	7704620800450	7,50	50	7704620800950	8,70	50
2									
Q8 P90	77046089001	77046089002	77046089003	77046089004	10,60	10	77046089009	12,10	10
	7704608900150	7704608900250	7704608900350	7704608900450	10,30	50	7704608900950	11,90	50
Q8 P70	77046087001	77046087002	77046087003	77046087004	10,60	10	77046087009	12,10	10
	7704608700150	7704608700250	7704608700350	7704608700450	10,30	50	7704608700950	11,90	50
Q8 PY85	77046088501	77046088502	77046088503	77046088504	10,60	10	77046088509	12,10	10
	7704608850150	7704608850250	7704608850350	7704608850450	10,30	50	7704608850950	11,90	50
3									
Q8 R 45	77046280001	77046280002	77046280003	77046280004	9,50	10	77046280009	10,90	10
	7704628000150	7704628000250	7704628000350	7704628000450	9,30	50	7704628000950	10,80	50
Q8 RB 45	77046281001	77046281002	77046281003	77046281004	11,30	10	77046281009	13,00	10
	7704628100150	7704628100250	7704628100350	7704628100450	11,10	50	7704628100950	12,80	50
Q8 RBY 45	77046285001	77046285002	77046285003	77046285004	11,30	10	77046285009	13,00	10
	7704628500150	7704628500250	7704628500350	7704628500450	11,10	50	7704628500950	12,80	50
4									
Q8 R 50	77046230001	77046230002	77046230003	77046230004	9,70	10	77046230009	11,10	10
	7704623000150	7704623000250	7704623000350	7704623000450	9,50	50	7704623000950	10,90	50
Q8 RB 50	77046231001	77046231002	77046231003	77046231004	11,70	10	77046231009	13,40	10
	7704623100150	7704623100250	7704623100350	7704623100450	11,40	50	7704623100950	13,20	50
Q8 RBB 50	77046231701	77046231702	77046231703	77046231704	11,70	10	77046231709	13,40	10
	7704623170150	7704623170250	7704623170350	7704623170450	11,40	50	7704623170950	13,20	50
Q8 RBY 50	77046235001	77046235002	77046235003	77046235004	11,70	10	77046235009	13,40	10
	7704623500150	7704623500250	7704623500350	7704623500450	11,40	50	7704623500950	13,20	50
5									
Q8 R 50 C/B	77046250501	77046250502	77046250503	77046250504	9,70	10	77046250509	11,10	10
	7704625050150	7704625050250	7704625050350	7704625050450	9,50	50	7704625050950	10,90	50
Q8 RB 50 C/B	77046251501	77046251502	77046251503	77046251504	11,70	10	77046251509	13,40	10
	7704625150150	7704625150250	7704625150350	7704625150450	11,40	50	7704625150950	13,20	50
Q8 RBB 50 C/B	77046251701	77046251702	77046251703	77046251704	11,70	10	77046251709	13,40	10
	7704625170150	7704625170250	7704625170350	7704625170450	11,40	50	7704625170950	13,20	50
Q8 RBY 50 C/B	77046255501	77046255502	77046255503	77046255504	11,70	10	77046255509	13,40	10
	7704625550150	7704625550250	7704625550350	7704625550450	11,40	50	7704625550950	13,20	50
6									
Q8 RBWC Q6 50	77046238001	77046238002	77046238003	77046238004	14,60	10	77046238009	16,90	10
	7704623800150	7704623800250	7704623800350	7704623800450	14,40	50	7704623800950	16,70	50
Q8 RBWC Q8 50	77046238801	77046238802	77046238803	77046238804	14,60	10	77046238809	16,90	10
	7704623880150	7704623880250	7704623880350	7704623880450	14,40	50	7704623880950	16,70	50
7									
Q8 RBWC Q6 50 C/B	77046258001	77046258002	77046258003	77046258004	15,60	10	77046258009	18,00	10
	7704625800150	7704625800250	7704625800350	7704625800450	15,40	50	7704625800950	17,70	50
Q8 RBWC Q8 50 C/B	77046258801	77046258802	77046258803	77046258804	15,60	10	77046258809	18,00	10
	7704625880150	7704625880250	7704625880350	7704625880450	15,40	50	7704625880950	17,70	50



F1

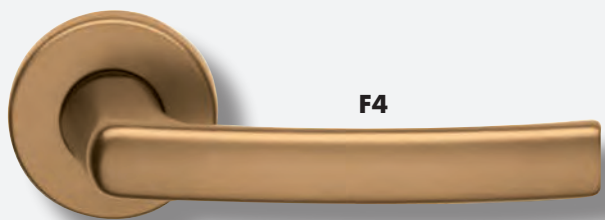

F4

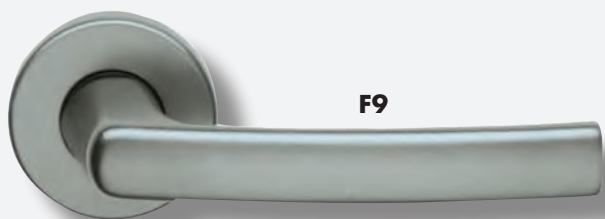

F9

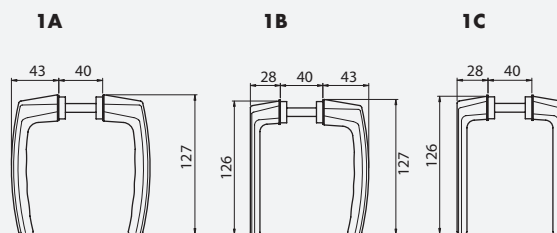

2

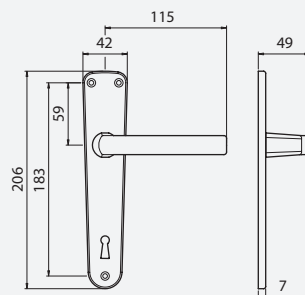

3

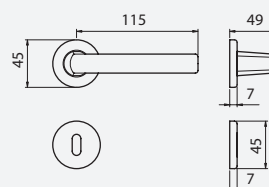

4

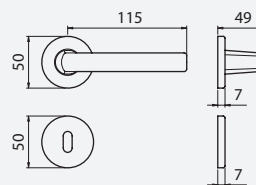

5

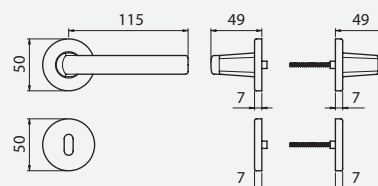

6

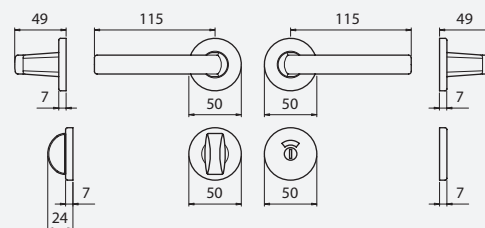

7

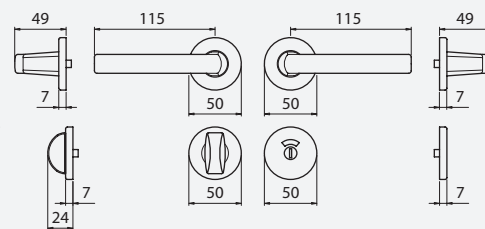

Finiture disponibili a richiesta:
 Available finishings on request:

Bianco/White RAL 9010
 Nero/Black RAL 9005 Lucido/Bright
 Nero/Black RAL 9005 Opaco/Matt

Martellina DK a pag.367
 Window handle pag.367

1A	F1	F2	F3	F4	€	Conf. pz.	F9	€	Conf. pz.
Q8 BIL	77486208001	77486208002	77486208003	77486208004	7,30	10	77486208009	8,40	10
	7748620800150	7748620800250	7748620800350	7748620800450	7,10	50	7748620800950	8,20	50
1B									
Q8 BIL CB+CA	77490208001	77490208002	77490208003	77490208004	7,30	10	77490208009	8,40	10
	7749020800150	7749020800250	7749020800350	7749020800450	7,10	50	7749020800950	8,20	50
1C									
Q8 BIL CB	77488208001	77488208002	77488208003	77488208004	7,30	10	77488208009	8,40	10
	7748820800150	7748820800250	7748820800350	7748820800450	7,10	50	7748820800950	8,20	50
2									
Q8 P90	77486089001	77486089002	77486089003	77486089004	10,10	10	77486089009	11,70	10
	7748608900150	7748608900250	7748608900350	7748608900450	9,90	50	7748608900950	11,40	50
Q8 P70	77486087001	77486087002	77486087003	77486087004	10,10	10	77486087009	11,70	10
	7748608700150	7748608700250	7748608700350	7748608700450	9,90	50	7748608700950	11,40	50
Q8 PY85	77486088501	77486088502	77486088503	77486088504	10,10	10	77486088509	11,70	10
	7748608850150	7748608850250	7748608850350	7748608850450	9,90	50	7748608850950	11,40	50
3									
Q8 R 45	77486280001	77486280002	77486280003	77486280004	9,10	10	77486280009	10,40	10
	7748628000150	7748628000250	7748628000350	7748628000450	8,90	50	7748628000950	10,30	50
Q8 RB 45	77486281001	77486281002	77486281003	77486281004	10,90	10	77486281009	12,50	10
	7748628100150	7748628100250	7748628100350	7748628100450	10,70	50	7748628100950	12,30	50
Q8 RBY 45	77486285001	77486285002	77486285003	77486285004	10,90	10	77486285009	12,50	10
	7748628500150	7748628500250	7748628500350	7748628500450	10,70	50	7748628500950	12,30	50
4									
Q8 R 50	77486230001	77486230002	77486230003	77486230004	9,30	10	77486230009	10,70	10
	7748623000150	7748623000250	7748623000350	7748623000450	9,10	50	7748623000950	10,40	50
Q8 RB 50	77486231001	77486231002	77486231003	77486231004	11,30	10	77486231009	13,00	10
	7748623100150	7748623100250	7748623100350	7748623100450	11,10	50	7748623100950	12,80	50
Q8 RBB 50	77486231701	77486231702	77486231703	77486231704	11,30	10	77486231709	13,00	10
	7748623170150	7748623170250	7748623170350	7748623170450	11,10	50	7748623170950	12,80	50
Q8 RBY 50	77486235001	77486235002	77486235003	77486235004	11,30	10	77486235009	13,00	10
	7748623500150	7748623500250	7748623500350	7748623500450	11,10	50	7748623500950	12,80	50
5									
Q8 R 50 C/B	77486250501	77486250502	77486250503	77486250504	9,30	10	77486250509	10,70	10
	7748625050150	7748625050250	7748625050350	7748625050450	9,10	50	7748625050950	10,40	50
Q8 RB 50 C/B	77486251501	77486251502	77486251503	77486251504	11,30	10	77486251509	13,00	10
	7748625150150	7748625150250	7748625150350	7748625150450	11,10	50	7748625150950	12,80	50
Q8 RBB 50 C/B	77486251701	77486251702	77486251703	77486251704	11,30	10	77486251709	13,00	10
	7748625170150	7748625170250	7748625170350	7748625170450	11,10	50	7748625170950	12,80	50
Q8 RBY 50 C/B	77486255501	77486255502	77486255503	77486255504	11,30	10	77486255509	13,00	10
	7748625550150	7748625550250	7748625550350	7748625550450	11,10	50	7748625550950	12,80	50
6									
Q8 RBWC Q6 50	77486238001	77486238002	77486238003	77486238004	14,20	10	77486238009	16,40	10
	7748623800150	7748623800250	7748623800350	7748623800450	14,10	50	7748623800950	16,20	50
Q8 RBWC Q8 50	77486238801	77486238802	77486238803	77486238804	14,20	10	77486238809	16,40	10
	7748623880150	7748623880250	7748623880350	7748623880450	14,10	50	7748623880950	16,20	50
7									
Q8 RBWC Q6 50 C/B	77486258001	77486258002	77486258003	77486258004	15,20	10	77486258009	17,50	10
	7748625800150	7748625800250	7748625800350	7748625800450	15,00	50	7748625800950	17,30	50
Q8 RBWC Q8 50 C/B	77486258801	77486258802	77486258803	77486258804	15,20	10	77486258809	17,50	10
	7748625880150	7748625880250	7748625880350	7748625880450	15,00	50	7748625880950	17,30	50



F1

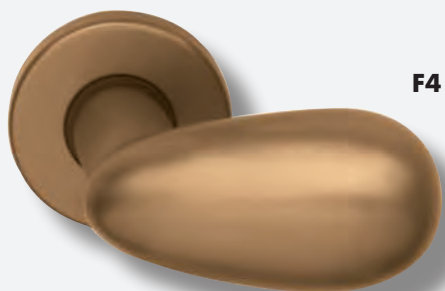

F4



F9

Finiture disponibili a richiesta:
 Available finishings on request:

Bianco/White RAL 9010
 Nero/Black RAL 9005 Lucido/Bright
 Nero/Black RAL 9005 Opaco/Matt

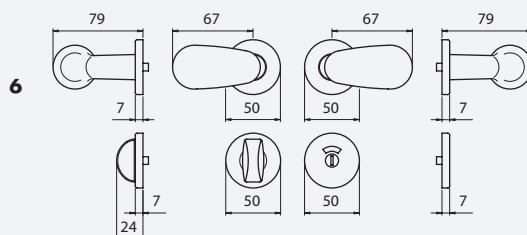
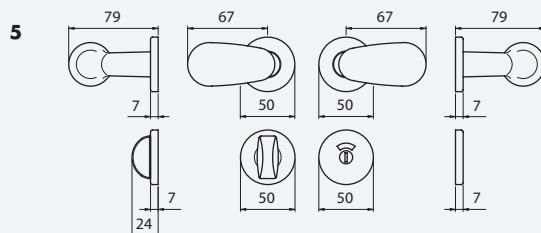
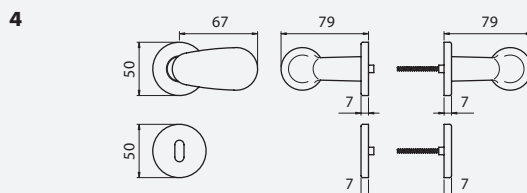
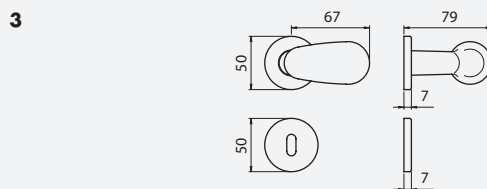
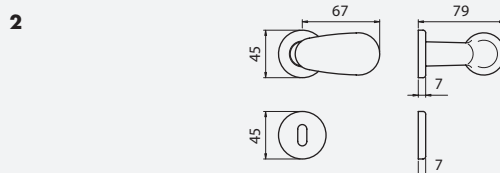
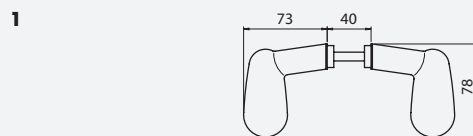

1	F1	F2	F3	F4	€	Conf. pz.	F9	€	Conf. pz.
Q8 BIL	72008208001	72008208002	72008208003	72008208004	12,40	10	72008208009	14,30	10
	7200820800150	7200820800250	7200820800350	7200820800450	12,20	50	7200820800950	14,10	50
2									
Q8 R 45	72008280001	72008280002	72008280003	72008280004	14,20	10	72008280009	16,40	10
	7200828000150	7200828000250	7200828000350	7200828000450	14,00	50	7200828000950	16,20	50
Q8 RB 45	72008281001	72008281002	72008281003	72008281004	16,00	10	72008281009	18,40	10
	7200828100150	7200828100250	7200828100350	7200828100450	15,80	50	7200828100950	18,20	50
Q8 RBY 45	72008285001	72008285002	72008285003	72008285004	16,00	10	72008285009	18,40	10
	7200828500150	7200828500250	7200828500350	7200828500450	15,80	50	7200828500950	18,20	50
3									
Q8 R 50	72008230001	72008230002	72008230003	72008230004	14,40	10	72008230009	16,50	10
	7200823000150	7200823000250	7200823000350	7200823000450	14,20	50	7200823000950	16,40	50
Q8 RB 50	72008231001	72008231002	72008231003	72008231004	16,40	10	72008231009	18,90	10
	7200823100150	7200823100250	7200823100350	7200823100450	16,20	50	7200823100950	18,70	50
Q8 RBB 50	72008231701	72008231702	72008231703	72008231704	16,40	10	72008231709	18,90	10
	7200823170150	7200823170250	7200823170350	7200823170450	16,20	50	7200823170950	18,70	50
Q8 RBY 50	72008235001	72008235002	72008235003	72008235004	16,40	10	72008235009	18,90	10
	7200823500150	7200823500250	7200823500350	7200823500450	16,20	50	7200823500950	18,70	50
4									
Q8 R 50 C/B	72008250501	72008250502	72008250503	72008250504	14,40	10	72008250509	16,50	10
	7200825050150	7200825050250	7200825050350	7200825050450	14,20	50	7200825050950	16,40	50
Q8 RB 50 C/B	72008251501	72008251502	72008251503	72008251504	16,40	10	72008251509	18,90	10
	7200825150150	7200825150250	7200825150350	7200825150450	16,20	50	7200825150950	18,70	50
Q8 RBB 50 C/B	72008251701	72008251702	72008251703	72008251704	16,40	10	72008251709	18,90	10
	7200825170150	7200825170250	7200825170350	7200825170450	16,20	50	7200825170950	18,70	50
Q8 RBY 50 C/B	72008255501	72008255502	72008255503	72008255504	16,40	10	72008255509	18,90	10
	7200825550150	7200825550250	7200825550350	7200825550450	16,20	50	7200825550950	18,70	50
5									
Q8 RBWC Q6 50	72008238001	72008238002	72008238003	72008238004	19,30	10	72008238009	22,30	10
	7200823800150	7200823800250	7200823800350	7200823800450	19,20	50	7200823800950	22,10	50
Q8 RBWC Q8 50	72008238801	72008238802	72008238803	72008238804	19,30	10	72008238809	22,30	10
	7200823880150	7200823880250	7200823880350	7200823880450	19,20	50	7200823880950	22,10	50
6									
Q8 RBWC Q6 50 C/B	72008258001	72008258002	72008258003	72008258004	20,30	10	72008258009	23,30	10
	7200825800150	7200825800250	7200825800350	7200825800450	20,10	50	7200825800950	23,10	50
Q8 RBWC Q8 50 C/B	72008258801	72008258802	72008258803	72008258804	20,30	10	72008258809	23,30	10
	7200825880150	7200825880250	7200825880350	7200825880450	20,10	50	7200825880950	23,10	50



F1

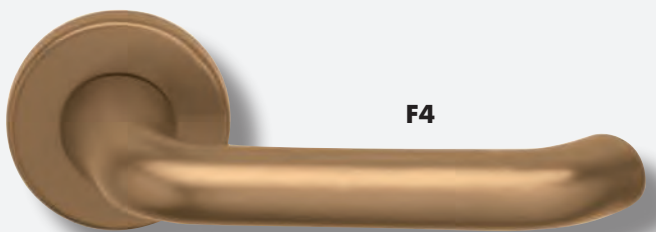

F4

1

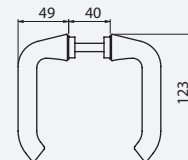

2

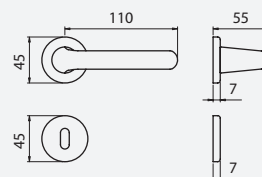

3

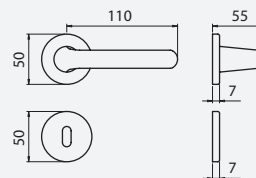

4

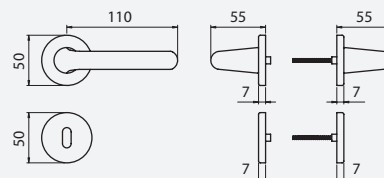

5

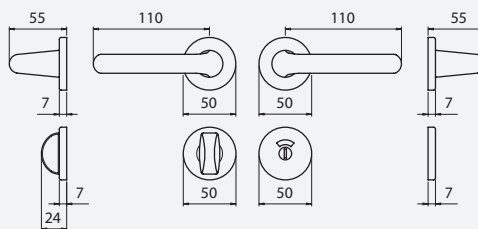

6

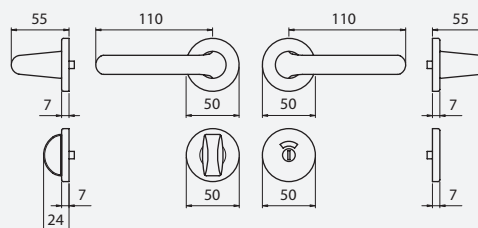

Finiture disponibili a richiesta:
 Available finishings on request:

Bianco/White RAL 9010
 Nero/Black RAL 9005 Lucido/Bright
 Nero/Black RAL 9005 Opaco/Matt

1	F1	F2	F3	F4	€	Conf. pz.
Q8 BIL	70010208001	70010208002	70010208003	70010208004	7,20	10
	7001020800150	7001020800250	7001020800350	7001020800450	7,00	50
2						
Q8 R 45	70010280001	70010280002	70010280003	70010280004	9,00	10
	7001028000150	7001028000250	7001028000350	7001028000450	8,80	50
Q8 RB 45	70010281001	70010281002	70010281003	70010281004	10,80	10
	7001028100150	7001028100250	7001028100350	7001028100450	10,60	50
Q8 RBY 45	70010285001	70010285002	70010285003	70010285004	10,80	10
	7001028500150	7001028500250	7001028500350	7001028500450	10,60	50
3						
Q8 R 50	70010230001	70010230002	70010230003	70010230004	9,20	10
	7001023000150	7001023000250	7001023000350	7001023000450	9,00	50
Q8 RB 50	70010231001	70010231002	70010231003	70010231004	11,20	10
	7001023100150	7001023100250	7001023100350	7001023100450	11,00	50
Q8 RBB 50	70010231701	70010231702	70010231703	70010231704	11,20	10
	7001023170150	7001023170250	7001023170350	7001023170450	11,00	50
Q8 RBY 50	70010235001	70010235002	70010235003	70010235004	11,20	10
	7001023500150	7001023500250	7001023500350	7001023500450	11,00	50
4						
Q8 R 50 C/B	70010250501	70010250502	70010250503	70010250504	9,20	10
	7001025050150	7001025050250	7001025050350	7001025050450	9,00	50
Q8 RB 50 C/B	70010251501	70010251502	70010251503	70010251504	11,20	10
	7001025150150	7001025150250	7001025150350	7001025150450	11,00	50
Q8 RBB 50 C/B	70010251701	70010251702	70010251703	70010251704	11,20	10
	7001025170150	7001025170250	7001025170350	7001025170450	11,00	50
Q8 RBY 50 C/B	70010255501	70010255502	70010255503	70010255504	11,20	10
	7001025550150	7001025550250	7001025550350	7001025550450	11,00	50
5						
Q8 RBWC Q6 50	70010238001	70010238002	70010238003	70010238004	14,20	10
	7001023800150	7001023800250	7001023800350	7001023800450	14,00	50
Q8 RBWC Q8 50	70010238801	70010238802	70010238803	70010238804	14,20	10
	7001023880150	7001023880250	7001023880350	7001023880450	14,00	50
6						
Q8 RBWC Q6 50 C/B	70010258001	70010258002	70010258003	70010258004	15,10	10
	7001025800150	7001025800250	7001025800350	7001025800450	14,90	50
Q8 RBWC Q8 50 C/B	70010258801	70010258802	70010258803	70010258804	15,10	10
	7001025880150	7001025880250	7001025880350	7001025880450	14,90	50



F1



F4

1

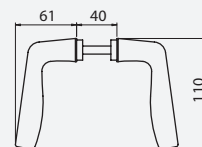

2

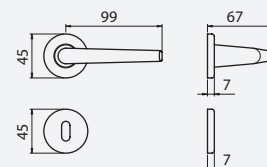

3

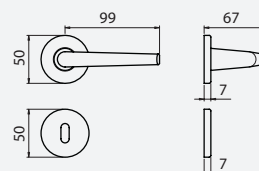

4

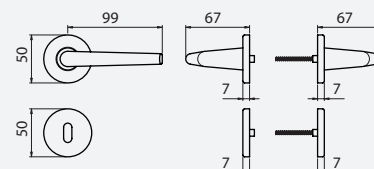

5

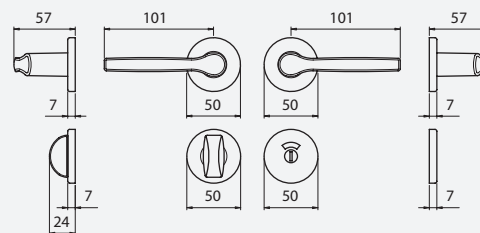

6

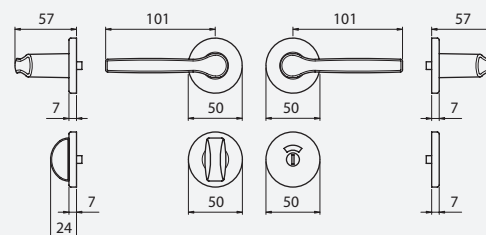

Finiture disponibili a richiesta:
Available finishings on request:

Bianco/White RAL 9010
Nero/Black RAL 9005 Lucido/Bright
Nero/Black RAL 9005 Opaco/Matt

1	F1	F2	F3	F4	€	Conf. pz.
Q8 BIL	70023208001	70023208002	70023208003	70023208004	6,80	10
	7002320800150	7002320800250	7002320800350	7002320800450	6,60	50
2						
Q8 R 45	70023280001	70023280002	70023280003	70023280004	8,60	10
	7002328000150	7002328000250	7002328000350	7002328000450	8,40	50
Q8 RB 45	70023281001	70023281002	70023281003	70023281004	10,40	10
	7002328100150	7002328100250	7002328100350	7002328100450	10,20	50
Q8 RBY 45	70023285001	70023285002	70023285003	70023285004	10,40	10
	7002328500150	7002328500250	7002328500350	7002328500450	10,20	50
3						
Q8 R 50	70023230001	70023230002	70023230003	70023230004	8,80	10
	7002323000150	7002323000250	7002323000350	7002323000450	8,60	50
Q8 RB 50	70023231001	70023231002	70023231003	70023231004	10,80	10
	7002323100150	7002323100250	7002323100350	7002323100450	10,60	50
Q8 RBB 50	70023231701	70023231702	70023231703	70023231704	10,80	10
	7002323170150	7002323170250	7002323170350	7002323170450	10,60	50
Q8 RBY 50	70023235001	70023235002	70023235003	70023235004	10,80	10
	7002323500150	7002323500250	7002323500350	7002323500450	10,60	50
4						
Q8 R 50 C/B	70023250501	70023250502	70023250503	70023250504	8,80	10
	7002325050150	7002325050250	7002325050350	7002325050450	8,60	50
Q8 RB 50 C/B	70023251501	70023251502	70023251503	70023251504	10,80	10
	7002325150150	7002325150250	7002325150350	7002325150450	10,60	50
Q8 RBB 50 C/B	70023251701	70023251702	70023251703	70023251704	10,80	10
	7002325170150	7002325170250	7002325170350	7002325170450	10,60	50
Q8 RBY 50 C/B	70023255501	70023255502	70023255503	70023255504	10,80	10
	7002325550150	7002325550250	7002325550350	7002325550450	10,60	50
5						
Q8 RBWC Q6 50	70023238001	70023238002	70023238003	70023238004	13,80	10
	7002323800150	7002323800250	7002323800350	7002323800450	13,60	50
Q8 RBWC Q8 50	70023238801	70023238802	70023238803	70023238804	13,80	10
	7002323880150	7002323880250	7002323880350	7002323880450	13,60	50
6						
Q8 RBWC Q6 50 C/B	70023258001	70023258002	70023258003	70023258004	14,70	10
	7002325800150	7002325800250	7002325800350	7002325800450	14,50	50
Q8 RBWC Q8 50 C/B	70023258801	70023258802	70023258803	70023258804	14,70	10
	7002325880150	7002325880250	7002325880350	7002325880450	14,50	50



F1

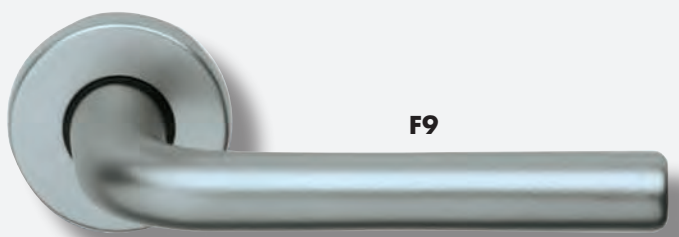

F9

1

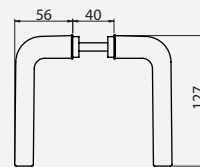

2

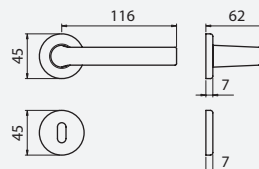

3

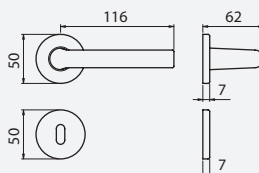

4

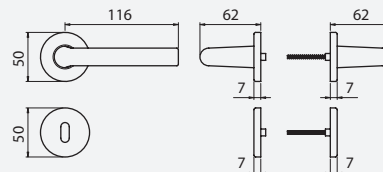

5

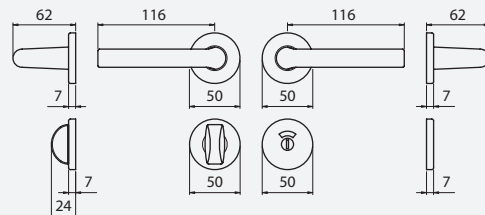

6

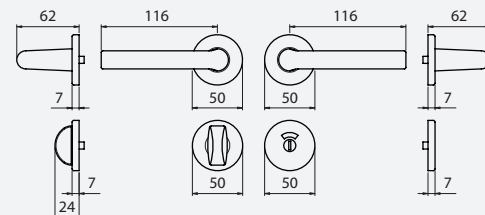

Finiture disponibili a richiesta:
Available finishings on request:

Bianco/White RAL 9010
Nero/Black RAL 9005 Lucido/Bright
Nero/Black RAL 9005 Opaco/Matt

1	F1	F2	F3	F4	€	Conf. pz.	F9	€	Conf. pz.
Q8 BIL	70138208001	70138208002	70138208003	70138208004	7,10	10	70138208009	8,20	10
	7013820800150	7013820800250	7013820800350	7013820800450	6,90	50	7013820800950	8,00	50
2									
Q8 R 45	70138280001	70138280002	70138280003	70138280004	8,90	10	70138280009	10,30	10
	7013828000150	7013828000250	7013828000350	7013828000450	8,70	50	7013828000950	10,10	50
Q8 RB 45	70138281001	70138281002	70138281003	70138281004	10,70	10	70138281009	12,30	10
	7013828100150	7013828100250	7013828100350	7013828100450	10,40	50	7013828100950	12,10	50
Q8 RBY 45	70138285001	70138285002	70138285003	70138285004	10,70	10	70138285009	12,30	10
	7013828500150	7013828500250	7013828500350	7013828500450	10,40	50	7013828500950	12,10	50
3									
Q8 R 50	70138230001	70138230002	70138230003	70138230004	9,10	10	70138230009	10,40	10
	7013823000150	7013823000250	7013823000350	7013823000450	8,90	50	7013823000950	10,30	50
Q8 RB 50	70138231001	70138231002	70138231003	70138231004	11,10	10	70138231009	12,80	10
	7013823100150	7013823100250	7013823100350	7013823100450	10,90	50	7013823100950	12,60	50
Q8 RBB 50	70138231701	70138231702	70138231703	70138231704	11,10	10	70138231709	12,80	10
	7013823170150	7013823170250	7013823170350	7013823170450	10,90	50	7013823170950	12,60	50
Q8 RBY 50	70138235001	70138235002	70138235003	70138235004	11,10	10	70138235009	12,80	10
	7013823500150	7013823500250	7013823500350	7013823500450	10,90	50	7013823500950	12,60	50
4									
Q8 R 50 C/B	70138250501	70138250502	70138250503	70138250504	9,10	10	70138250509	10,40	10
	7013825050150	7013825050250	7013825050350	7013825050450	8,90	50	7013825050950	10,30	50
Q8 RB 50 C/B	70138251501	70138251502	70138251503	70138251504	11,10	10	70138251509	12,80	10
	7013825150150	7013825150250	7013825150350	7013825150450	10,90	50	7013825150950	12,60	50
Q8 RBB 50 C/B	70138251701	70138251702	70138251703	70138251704	11,10	10	70138251709	12,80	10
	7013825170150	7013825170250	7013825170350	7013825170450	10,90	50	7013825170950	12,60	50
Q8 RBY 50 C/B	70138255501	70138255502	70138255503	70138255504	11,10	10	70138255509	12,80	10
	7013825550150	7013825550250	7013825550350	7013825550450	10,90	50	7013825550950	12,60	50
5									
Q8 RBWC Q6 50	70138238001	70138238002	70138238003	70138238004	14,10	10	70138238009	16,20	10
	7013823800150	7013823800250	7013823800350	7013823800450	13,90	50	7013823800950	16,00	50
Q8 RBWC Q8 50	70138238801	70138238802	70138238803	70138238804	14,10	10	70138238809	16,20	10
	7013823880150	7013823880250	7013823880350	7013823880450	13,90	50	7013823880950	16,00	50
6									
Q8 RBWC Q6 50 C/B	70138258001	70138258002	70138258003	70138258004	15,00	10	70138258009	17,20	10
	7013825800150	7013825800250	7013825800350	7013825800450	14,80	50	7013825800950	17,00	50
Q8 RBWC Q8 50 C/B	70138258801	70138258802	70138258803	70138258804	15,00	10	70138258809	17,20	10
	7013825880150	7013825880250	7013825880350	7013825880450	14,80	50	7013825880950	17,00	50

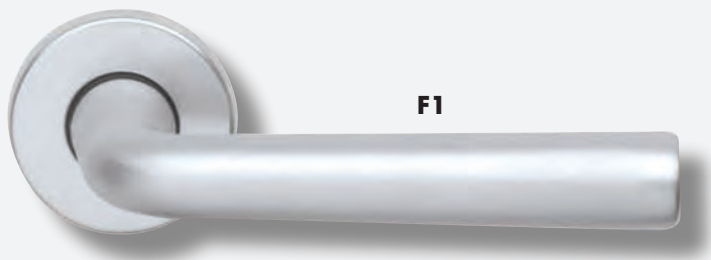

1

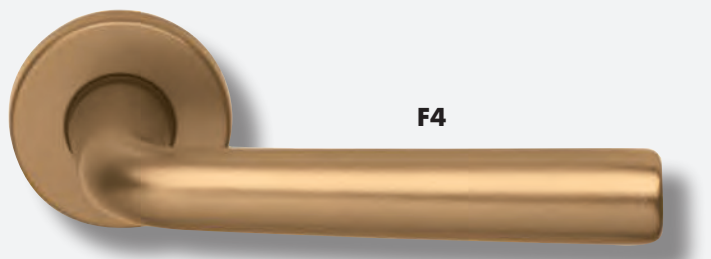
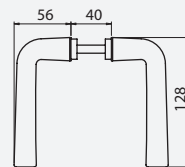

2

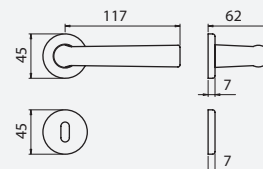

3

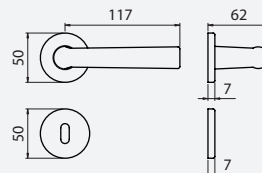

4

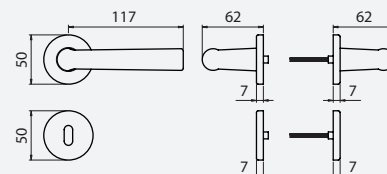

5

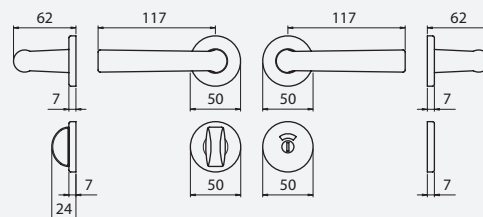

6

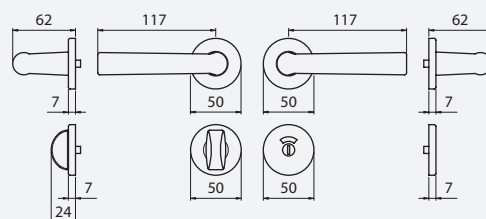

Finiture disponibili a richiesta:
Available finishings on request:

Bianco/White RAL 9010
Nero/Black RAL 9005 Lucido/Bright
Nero/Black RAL 9005 Opaco/Matt

1	F1	F2	F3	F4	€	Conf. pz.	F9	€	Conf. pz.
Q8 BIL	70141208001	70141208002	70141208003	70141208004	7,70	10	70141208009	8,90	10
	7014120800150	7014120800250	7014120800350	7014120800450	7,50	50	7014120800950	8,70	50
2									
Q8 R 45	70141280001	70141280002	70141280003	70141280004	9,50	10	70141280009	10,90	10
	7014128000150	7014128000250	7014128000350	7014128000450	9,30	50	7014128000950	10,80	50
Q8 RB 45	70141281001	70141281002	70141281003	70141281004	11,30	10	70141281009	13,00	10
	7014128100150	7014128100250	7014128100350	7014128100450	11,10	50	7014128100950	12,80	50
Q8 RBY 45	70141285001	70141285002	70141285003	70141285004	11,30	10	70141285009	13,00	10
	7014128500150	7014128500250	7014128500350	7014128500450	11,10	50	7014128500950	12,80	50
3									
Q8 R 50	70141230001	70141230002	70141230003	70141230004	9,70	10	70141230009	11,10	10
	7014123000150	7014123000250	7014123000350	7014123000450	9,50	50	7014123000950	10,90	50
Q8 RB 50	70141231001	70141231002	70141231003	70141231004	11,70	10	70141231009	13,40	10
	7014123100150	7014123100250	7014123100350	7014123100450	11,40	50	7014123100950	13,20	50
Q8 RBB 50	70141231701	70141231702	70141231703	70141231704	11,70	10	70141231709	13,40	10
	7014123170150	7014123170250	7014123170350	7014123170450	11,40	50	7014123170950	13,20	50
Q8 RBY 50	70141235001	70141235002	70141235003	70141235004	11,70	10	70141235009	13,40	10
	7014123500150	7014123500250	7014123500350	7014123500450	11,40	50	7014123500950	13,20	50
4									
Q8 R 50 C/B	70141250501	70141250502	70141250503	70141250504	9,70	10	70141250509	11,10	10
	7014125050150	7014125050250	7014125050350	7014125050450	9,50	50	7014125050950	10,90	50
Q8 RB 50 C/B	70141251501	70141251502	70141251503	70141251504	11,70	10	70141251509	13,40	10
	7014125150150	7014125150250	7014125150350	7014125150450	11,40	50	7014125150950	13,20	50
Q8 RBB 50 C/B	70141251701	70141251702	70141251703	70141251704	11,70	10	70141251709	13,40	10
	7014125170150	7014125170250	7014125170350	7014125170450	11,40	50	7014125170950	13,20	50
Q8 RBY 50 C/B	70141255501	70141255502	70141255503	70141255504	11,70	10	70141255509	13,40	10
	7014125550150	7014125550250	7014125550350	7014125550450	11,40	50	7014125550950	13,20	50
5									
Q8 RBWC Q6 50	70141238001	70141238002	70141238003	70141238004	14,60	10	70141238009	16,90	10
	7014123800150	7014123800250	7014123800350	7014123800450	14,40	50	7014123800950	16,70	50
Q8 RBWC Q8 50	70141238801	70141238802	70141238803	70141238804	14,60	10	70141238809	16,90	10
	7014123880150	7014123880250	7014123880350	7014123880450	14,40	50	7014123880950	16,70	50
6									
Q8 RBWC Q6 50 C/B	70141258001	70141258002	70141258003	70141258004	15,60	10	70141258009	18,00	10
	7014125800150	7014125800250	7014125800350	7014125800450	15,40	50	7014125800950	17,70	50
Q8 RBWC Q8 50 C/B	70141258801	70141258802	70141258803	70141258804	15,60	10	70141258809	18,00	10
	7014125880150	7014125880250	7014125880350	7014125880450	15,40	50	7014125880950	17,70	50



F1



F4

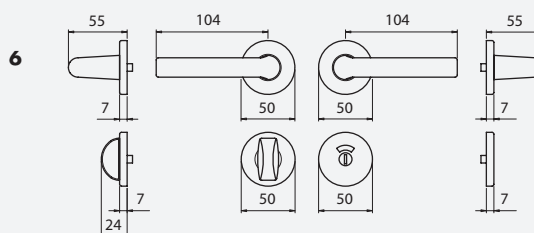
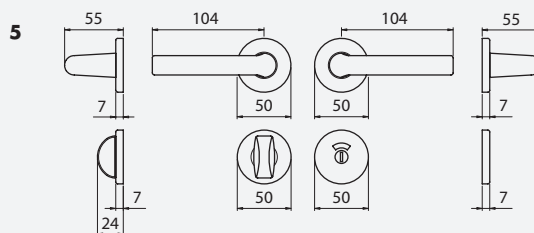
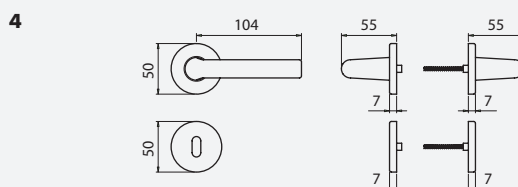
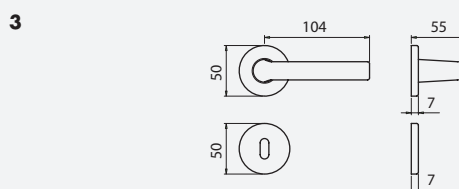
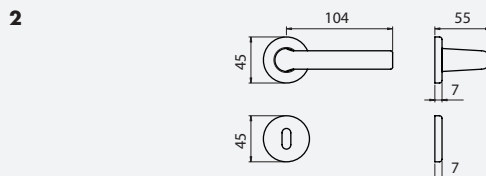
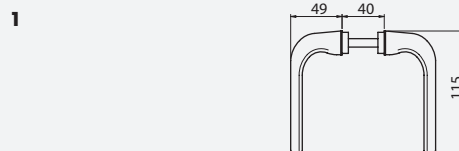

Finiture disponibili a richiesta:
Available finishings on request:

Bianco/White RAL 9010
Nero/Black RAL 9005 Lucido/Bright
Nero/Black RAL 9005 Opaco/Matt

1	F1	F2	F3	F4	€	Conf. pz.
Q8 BIL	70142208001	70142208002	70142208003	70142208004	6,20	10
	7014220800150	7014220800250	7014220800350	7014220800450	6,00	50
2						
Q8 R 45	70142280001	70142280002	70142280003	70142280004	8,00	10
	7014228000150	7014228000250	7014228000350	7014228000450	7,80	50
Q8 RB 45	70142281001	70142281002	70142281003	70142281004	9,80	10
	7014228100150	7014228100250	7014228100350	7014228100450	9,60	50
Q8 RBY 45	70142285001	70142285002	70142285003	70142285004	9,80	10
	7014228500150	7014228500250	7014228500350	7014228500450	9,60	50
3						
Q8 R 50	70142230001	70142230002	70142230003	70142230004	8,10	10
	7014223000150	7014223000250	7014223000350	7014223000450	8,00	50
Q8 RB 50	70142231001	70142231002	70142231003	70142231004	10,10	10
	7014223100150	7014223100250	7014223100350	7014223100450	9,90	50
Q8 RBB 50	70142231701	70142231702	70142231703	70142231704	10,10	10
	7014223170150	7014223170250	7014223170350	7014223170450	9,90	50
Q8 RBY 50	70142235001	70142235002	70142235003	70142235004	10,10	10
	7014223500150	7014223500250	7014223500350	7014223500450	9,90	50
4						
Q8 R 50 C/B	70142250501	70142250502	70142250503	70142250504	8,10	10
	7014225050150	7014225050250	7014225050350	7014225050450	8,00	50
Q8 RB 50 C/B	70142251501	70142251502	70142251503	70142251504	10,10	10
	7014225150150	7014225150250	7014225150350	7014225150450	9,90	50
Q8 RBB 50 C/B	70142251701	70142251702	70142251703	70142251704	10,10	10
	7014225170150	7014225170250	7014225170350	7014225170450	9,90	50
Q8 RBY 50 C/B	70142255501	70142255502	70142255503	70142255504	10,10	10
	7014225550150	7014225550250	7014225550350	7014225550450	9,90	50
5						
Q8 RBWC Q6 50	70142238001	70142238002	70142238003	70142238004	13,10	10
	7014223800150	7014223800250	7014223800350	7014223800450	12,90	50
Q8 RBWC Q8 50	70142238801	70142238802	70142238803	70142238804	13,10	10
	7014223880150	7014223880250	7014223880350	7014223880450	12,90	50
6						
Q8 RBWC Q6 50 C/B	70142258001	70142258002	70142258003	70142258004	14,10	10
	7014225800150	7014225800250	7014225800350	7014225800450	13,90	50
Q8 RBWC Q8 50 C/B	70142258801	70142258802	70142258803	70142258804	14,10	10
	7014225880150	7014225880250	7014225880350	7014225880450	13,90	50



F1

1

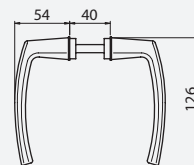

F4

2

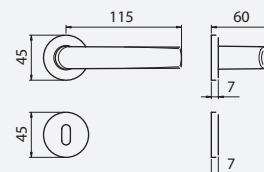

F9

3

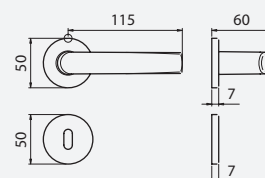

4

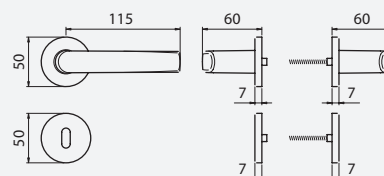

5

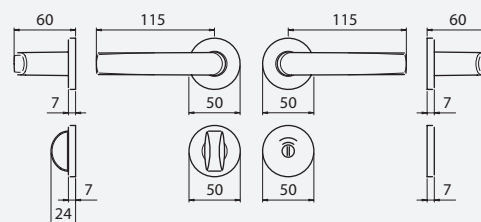

6

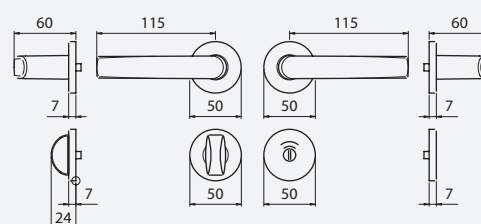

Finiture disponibili a richiesta:
Available finishings on request:

Bianco/White RAL 9010
Nero/Black RAL 9005 Lucido/Bright
Nero/Black RAL 9005 Opaco/Matt

1	F1	F2	F3	F4	€	Conf. pz.	F9	€	Conf. pz.
Q8 BIL	70143208001	70143208002	70143208003	70143208004	7,30	10	70143208009	8,40	10
	7014320800150	7014320800250	7014320800350	7014320800450	7,10	50	7014320800950	8,20	50
2									
Q8 R 45	70143280001	70143280002	70143280003	70143280004	9,10	10	70143280009	10,40	10
	7014328000150	7014328000250	7014328000350	7014328000450	8,90	50	7014328000950	10,30	50
Q8 RB 45	70143281001	70143281002	70143281003	70143281004	10,90	10	70143281009	12,50	10
	7014328100150	7014328100250	7014328100350	7014328100450	10,70	50	7014328100950	12,30	50
Q8 RBY 45	70143285001	70143285002	70143285003	70143285004	10,90	10	70143285009	12,50	10
	7014328500150	7014328500250	7014328500350	7014328500450	10,70	50	7014328500950	12,30	50
3									
Q8 R 50	70143230001	70143230002	70143230003	70143230004	9,30	10	70143230009	10,70	10
	7014323000150	7014323000250	7014323000350	7014323000450	9,10	50	7014323000950	10,40	50
Q8 RB 50	70143231001	70143231002	70143231003	70143231004	11,30	10	70143231009	13,00	10
	7014323100150	7014323100250	7014323100350	7014323100450	11,10	50	7014323100950	12,80	50
Q8 RBB 50	70143231701	70143231702	70143231703	70143231704	11,30	10	70143231709	13,00	10
	7014323170150	7014323170250	7014323170350	7014323170450	11,10	50	7014323170950	12,80	50
Q8 RBY 50	70143235001	70143235002	70143235003	70143235004	11,30	10	70143235009	13,00	10
	7014323500150	7014323500250	7014323500350	7014323500450	11,10	50	7014323500950	12,80	50
4									
Q8 R 50 C/B	70143250501	70143250502	70143250503	70143250504	9,30	10	70143250509	10,70	10
	7014325050150	7014325050250	7014325050350	7014325050450	9,10	50	7014325050950	10,40	50
Q8 RB 50 C/B	70143251501	70143251502	70143251503	70143251504	11,30	10	70143251509	13,00	10
	7014325150150	7014325150250	7014325150350	7014325150450	11,10	50	7014325150950	12,80	50
Q8 RBB 50 C/B	70143251701	70143251702	70143251703	70143251704	11,30	10	70143251709	13,00	10
	7014325170150	7014325170250	7014325170350	7014325170450	11,10	50	7014325170950	12,80	50
Q8 RBY 50 C/B	70143255501	70143255502	70143255503	70143255504	11,30	10	70143255509	13,00	10
	7014325550150	7014325550250	7014325550350	7014325550450	11,10	50	7014325550950	12,80	50
5									
Q8 RBWC Q6 50	70143238001	70143238002	70143238003	70143238004	14,20	10	70143238009	16,40	10
	7014323800150	7014323800250	7014323800350	7014323800450	14,10	50	7014323800950	16,20	50
Q8 RBWC Q8 50	70143238801	70143238802	70143238803	70143238804	14,20	10	70143238809	16,40	10
	7014323880150	7014323880250	7014323880350	7014323880450	14,10	50	7014323880950	16,20	50
6									
Q8 RBWC Q6 50 C/B	70143258001	70143258002	70143258003	70143258004	15,20	10	70143258009	17,50	10
	7014325800150	7014325800250	7014325800350	7014325800450	15,00	50	7014325800950	17,30	50
Q8 RBWC Q8 50 C/B	70143258801	70143258802	70143258803	70143258804	15,20	10	70143258809	17,50	10
	7014325880150	7014325880250	7014325880350	7014325880450	15,00	50	7014325880950	17,30	50



F1

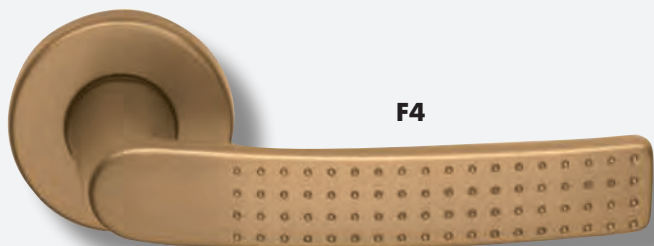

F4



F9

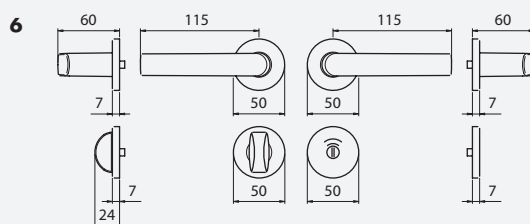
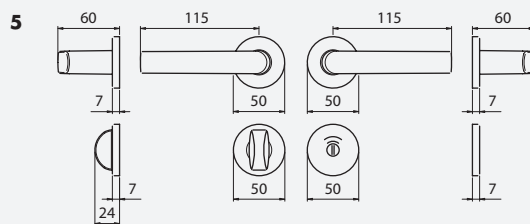
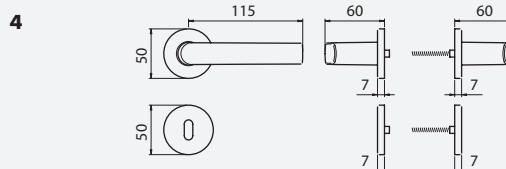
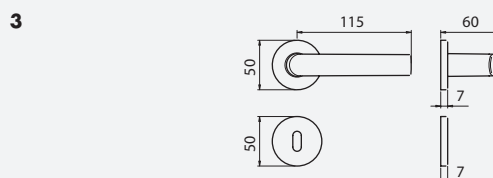
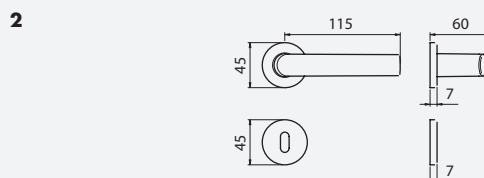
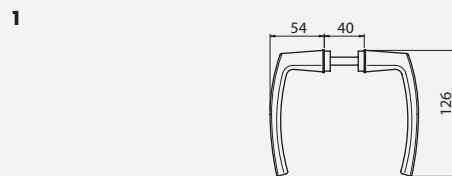

Finiture disponibili a richiesta:
Available finishings on request:

Bianco/White RAL 9010
Nero/Black RAL 9005 Lucido/Bright
Nero/Black RAL 9005 Opaco/Matt

1	F1	F2	F3	F4	€	Conf. pz.	F9	€	Conf. pz.
Q8 BIL	70144208001	70144208002	70144208003	70144208004	7,30	10	70144208009	8,40	10
	7014420800150	7014420800250	7014420800350	7014420800450	7,10	50	7014420800950	8,20	50
2									
Q8 R 45	70144280001	70144280002	70144280003	70144280004	9,10	10	70144280009	10,40	10
	7014428000150	7014428000250	7014428000350	7014428000450	8,90	50	7014428000950	10,30	50
Q8 RB 45	70144281001	70144281002	70144281003	70144281004	10,90	10	70144281009	12,50	10
	7014428100150	7014428100250	7014428100350	7014428100450	10,70	50	7014428100950	12,30	50
Q8 RBY 45	70144285001	70144285002	70144285003	70144285004	10,90	10	70144285009	12,50	10
	7014428500150	7014428500250	7014428500350	7014428500450	10,70	50	7014428500950	12,30	50
3									
Q8 R 50	70144230001	70144230002	70144230003	70144230004	9,30	10	70144230009	10,70	10
	7014423000150	7014423000250	7014423000350	7014423000450	9,10	50	7014423000950	10,40	50
Q8 RB 50	70144231001	70144231002	70144231003	70144231004	11,30	10	70144231009	13,00	10
	7014423100150	7014423100250	7014423100350	7014423100450	11,10	50	7014423100950	12,80	50
Q8 RBB 50	70144231701	70144231702	70144231703	70144231704	11,30	10	70144231709	13,00	10
	7014423170150	7014423170250	7014423170350	7014423170450	11,10	50	7014423170950	12,80	50
Q8 RBY 50	70144235001	70144235002	70144235003	70144235004	11,30	10	70144235009	13,00	10
	7014423500150	7014423500250	7014423500350	7014423500450	11,10	50	7014423500950	12,80	50
4									
Q8 R 50 C/B	70144250501	70144250502	70144250503	70144250504	9,30	10	70144250509	10,70	10
	7014425050150	7014425050250	7014425050350	7014425050450	9,10	50	7014425050950	10,40	50
Q8 RB 50 C/B	70144251501	70144251502	70144251503	70144251504	11,30	10	70144251509	13,00	10
	7014425150150	7014425150250	7014425150350	7014425150450	11,10	50	7014425150950	12,80	50
Q8 RBB 50 C/B	70144251701	70144251702	70144251703	70144251704	11,30	10	70144251709	13,00	10
	7014425170150	7014425170250	7014425170350	7014425170450	11,10	50	7014425170950	12,80	50
Q8 RBY 50 C/B	70144255501	70144255502	70144255503	70144255504	11,30	10	70144255509	13,00	10
	7014425550150	7014425550250	7014425550350	7014425550450	11,10	50	7014425550950	12,80	50
5									
Q8 RBWC Q6 50	70144238001	70144238002	70144238003	70144238004	14,20	10	70144238009	16,40	10
	7014423800150	7014423800250	7014423800350	7014423800450	14,10	50	7014423800950	16,20	50
Q8 RBWC Q8 50	70144238801	70144238802	70144238803	70144238804	14,20	10	70144238809	16,40	10
	7014423880150	7014423880250	7014423880350	7014423880450	14,10	50	7014423880950	16,20	50
6									
Q8 RBWC Q6 50 C/B	70144258001	70144258002	70144258003	70144258004	15,20	10	70144258009	17,50	10
	7014425800150	7014425800250	7014425800350	7014425800450	15,00	50	7014425800950	17,30	50
Q8 RBWC Q8 50 C/B	70144258801	70144258802	70144258803	70144258804	15,20	10	70144258809	17,50	10
	7014425880150	7014425880250	7014425880350	7014425880450	15,00	50	7014425880950	17,30	50



F1

1

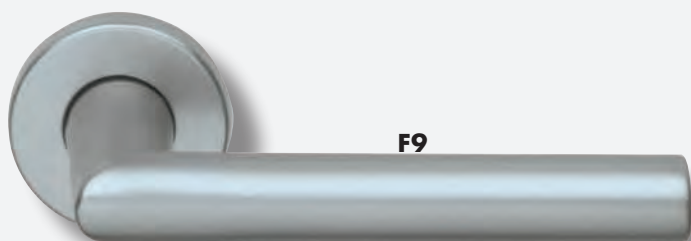
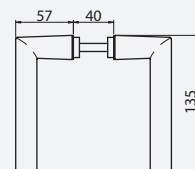

F9

2

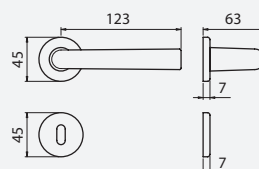

3

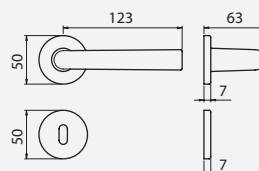

4

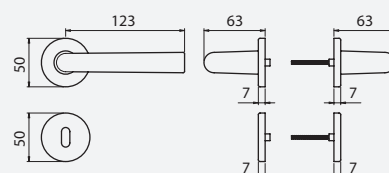

5

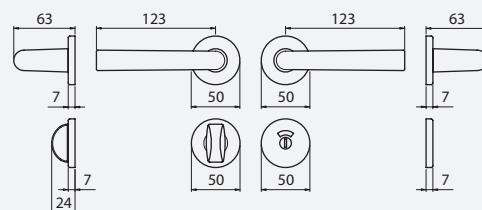

6

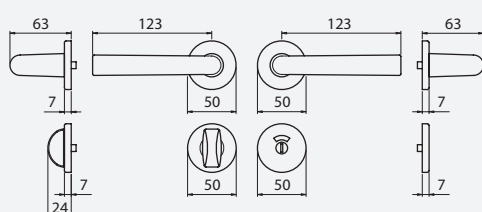

Finiture disponibili a richiesta:
Available finishings on request:

Bianco/White RAL 9010
Nero/Black RAL 9005 Lucido/Bright
Nero/Black RAL 9005 Opaco/Matt

1	F1	F2	F3	F4	€	Conf. pz.	F9	€	Conf. pz.
Q8 BIL	70190208001	70190208002	70190208003	70190208004	8,90	10	70190208009	10,30	10
	7019020800150	7019020800250	7019020800350	7019020800450	8,70	50	7019020800950	10,10	50
2									
Q8 R 45	70190280001	70190280002	70190280003	70190280004	10,70	10	70190280009	12,30	10
	7019028000150	7019028000250	7019028000350	7019028000450	10,40	50	7019028000950	12,10	50
Q8 RB 45	70190281001	70190281002	70190281003	70190281004	12,40	10	70190281009	14,40	10
	7019028100150	7019028100250	7019028100350	7019028100450	12,30	50	7019028100950	14,20	50
Q8 RBY 45	70190285001	70190285002	70190285003	70190285004	12,40	10	70190285009	14,40	10
	7019028500150	7019028500250	7019028500350	7019028500450	12,30	50	7019028500950	14,20	50
3									
Q8 R 50	70190230001	70190230002	70190230003	70190230004	10,90	10	70190230009	12,50	10
	7019023000150	7019023000250	7019023000350	7019023000450	10,70	50	7019023000950	12,30	50
Q8 RB 50	70190231001	70190231002	70190231003	70190231004	12,90	10	70190231009	14,90	10
	7019023100150	7019023100250	7019023100350	7019023100450	12,70	50	7019023100950	14,60	50
Q8 RBB 50	70190231701	70190231702	70190231703	70190231704	12,90	10	70190231709	14,90	10
	7019023170150	7019023170250	7019023170350	7019023170450	12,70	50	7019023170950	14,60	50
Q8 RBY 50	70190235001	70190235002	70190235003	70190235004	12,90	10	70190235009	14,90	10
	7019023500150	7019023500250	7019023500350	7019023500450	12,70	50	7019023500950	14,60	50
4									
Q8 R 50 C/B	70190250501	70190250502	70190250503	70190250504	10,90	10	70190250509	12,50	10
	7019025050150	7019025050250	7019025050350	7019025050450	10,70	50	7019025050950	12,30	50
Q8 RB 50 C/B	70190251501	70190251502	70190251503	70190251504	12,90	10	70190251509	14,90	10
	7019025150150	7019025150250	7019025150350	7019025150450	12,70	50	7019025150950	14,60	50
Q8 RBB 50 C/B	70190251701	70190251702	70190251703	70190251704	12,90	10	70190251709	14,90	10
	7019025170150	7019025170250	7019025170350	7019025170450	12,70	50	7019025170950	14,60	50
Q8 RBY 50 C/B	70190255501	70190255502	70190255503	70190255504	12,90	10	70190255509	14,90	10
	7019025550150	7019025550250	7019025550350	7019025550450	12,70	50	7019025550950	14,60	50
5									
Q8 RBWC Q6 50	70190238001	70190238002	70190238003	70190238004	15,90	10	70190238009	18,20	10
	7019023800150	7019023800250	7019023800350	7019023800450	15,60	50	7019023800950	18,00	50
Q8 RBWC Q8 50	70190238801	70190238802	70190238803	70190238804	15,90	10	70190238809	18,20	10
	7019023880150	7019023880250	7019023880350	7019023880450	15,60	50	7019023880950	18,00	50
6									
Q8 RBWC Q6 50 C/B	70190258001	70190258002	70190258003	70190258004	16,70	10	70190258009	19,30	10
	7019025800150	7019025800250	7019025800350	7019025800450	16,50	50	7019025800950	19,10	50
Q8 RBWC Q8 50 C/B	70190258801	70190258802	70190258803	70190258804	16,70	10	70190258809	19,30	10
	7019025880150	7019025880250	7019025880350	7019025880450	16,50	50	7019025880950	19,10	50



F1



F4

1

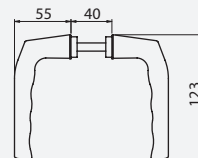

2

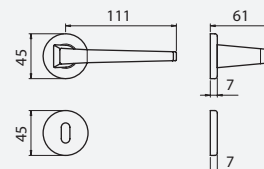

3

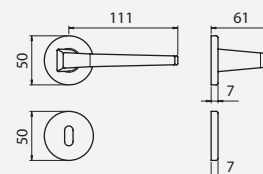

4

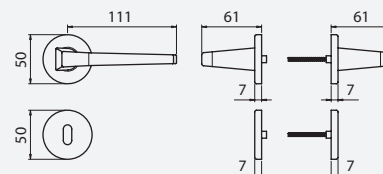

5

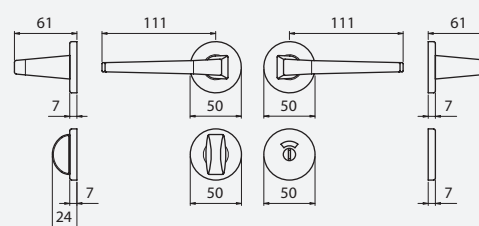

6

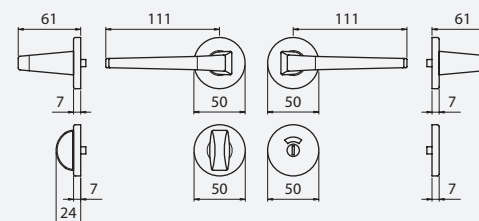

Finiture disponibili a richiesta:
Available finishings on request:

Bianco/White RAL 9010
Nero/Black RAL 9005 Lucido/Bright
Nero/Black RAL 9005 Opaco/Matt

1	F1	F2	F3	F4	€	Conf. pz.
Q8 BIL	70220208001	70220208002	70220208003	70220208004	7,10	10
	7022020800150	7022020800250	7022020800350	7022020800450	6,90	50
2						
Q8 R 45	70220280001	70220280002	70220280003	70220280004	8,90	10
	7022028000150	7022028000250	7022028000350	7022028000450	8,70	50
Q8 RB 45	70220281001	70220281002	70220281003	70220281004	10,70	10
	7022028100150	7022028100250	7022028100350	7022028100450	10,40	50
Q8 RBY 45	70220285001	70220285002	70220285003	70220285004	10,70	10
	7022028500150	7022028500250	7022028500350	7022028500450	10,40	50
3						
Q8 R 50	70220230001	70220230002	70220230003	70220230004	9,10	10
	7022023000150	7022023000250	7022023000350	7022023000450	8,90	50
Q8 RB 50	70220231001	70220231002	70220231003	70220231004	11,10	10
	7022023100150	7022023100250	7022023100350	7022023100450	10,90	50
Q8 RBB 50	70220231701	70220231702	70220231703	70220231704	11,10	10
	7022023170150	7022023170250	7022023170350	7022023170450	10,90	50
Q8 RBY 50	70220235001	70220235002	70220235003	70220235004	11,10	10
	7022023500150	7022023500250	7022023500350	7022023500450	10,90	50
4						
Q8 R 50 C/B	70220250501	70220250502	70220250503	70220250504	9,10	10
	7022025050150	7022025050250	7022025050350	7022025050450	8,90	50
Q8 RB 50 C/B	70220251501	70220251502	70220251503	70220251504	11,10	10
	7022025150150	7022025150250	7022025150350	7022025150450	10,90	50
Q8 RBB 50 C/B	70220251701	70220251702	70220251703	70220251704	11,10	10
	7022025170150	7022025170250	7022025170350	7022025170450	10,90	50
Q8 RBY 50 C/B	70220255501	70220255502	70220255503	70220255504	11,10	10
	7022025550150	7022025550250	7022025550350	7022025550450	10,90	50
5						
Q8 RBWC Q6 50	70220238001	70220238002	70220238003	70220238004	14,10	10
	7022023800150	7022023800250	7022023800350	7022023800450	13,90	50
Q8 RBWC Q8 50	70220238801	70220238802	70220238803	70220238804	14,10	10
	7022023880150	7022023880250	7022023880350	7022023880450	13,90	50
6						
Q8 RBWC Q6 50 C/B	70220258001	70220258002	70220258003	70220258004	15,00	10
	7022025800150	7022025800250	7022025800350	7022025800450	14,80	50
Q8 RBWC Q8 50 C/B	70220258801	70220258802	70220258803	70220258804	15,00	10
	7022025880150	7022025880250	7022025880350	7022025880450	14,80	50



F1



F9



Finiture disponibili a richiesta:
 Available finishings on request:

Bianco/White RAL 9010
 Nero/Black RAL 9005 Lucido/Bright
 Nero/Black RAL 9005 Opaco/Matt

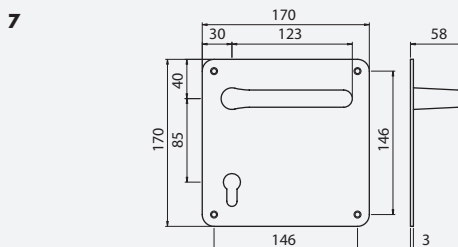
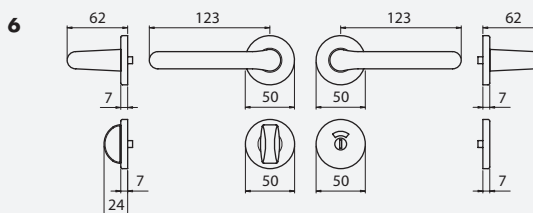
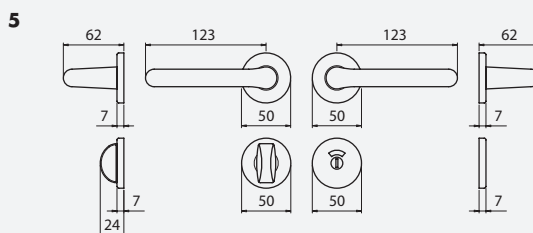
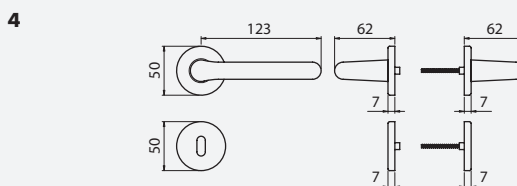
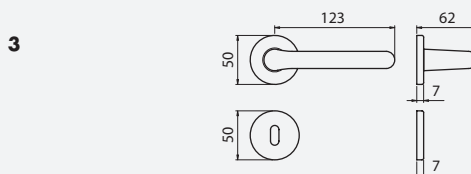
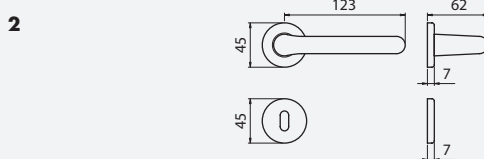
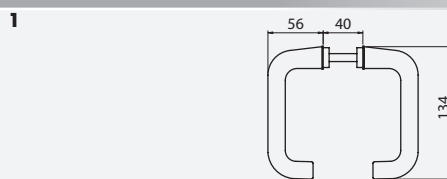

1	F1	F2	F3	F4	€	Conf. pz.	F9	€	Conf. pz.
Q8 BIL	70239208001	70239208002	70239208003	70239208004	9,30	10	70239208009	10,70	10
	7023920800150	7023920800250	7023920800350	7023920800450	9,10	50	7023920800950	10,40	50
2									
Q8 R 45	70239280001	70239280002	70239280003	70239280004	11,10	10	70239280009	12,80	10
	7023928000150	7023928000250	7023928000350	7023928000450	10,90	50	7023928000950	12,60	50
Q8 RB 45	70239281001	70239281002	70239281003	70239281004	12,90	10	70239281009	14,90	10
	7023928100150	7023928100250	7023928100350	7023928100450	12,70	50	7023928100950	14,60	50
Q8 RBY 45	70239285001	70239285002	70239285003	70239285004	12,90	10	70239285009	14,90	10
	7023928500150	7023928500250	7023928500350	7023928500450	12,70	50	7023928500950	14,60	50
3									
Q8 R 50	70239230001	70239230002	70239230003	70239230004	11,30	10	70239230009	13,00	10
	7023923000150	7023923000250	7023923000350	7023923000450	11,10	50	7023923000950	12,80	50
Q8 RB 50	70239231001	70239231002	70239231003	70239231004	13,20	10	70239231009	15,20	10
	7023923100150	7023923100250	7023923100350	7023923100450	13,10	50	7023923100950	15,00	50
Q8 RBB 50	70239231701	70239231702	70239231703	70239231704	13,20	10	70239231709	15,20	10
	7023923170150	7023923170250	7023923170350	7023923170450	13,10	50	7023923170950	15,00	50
Q8 RBY 50	70239235001	70239235002	70239235003	70239235004	13,20	10	70239235009	15,20	10
	7023923500150	7023923500250	7023923500350	7023923500450	13,10	50	7023923500950	15,00	50
4									
Q8 R 50 C/B	70239250501	70239250502	70239250503	70239250504	11,30	10	70239250509	13,00	10
	7023925050150	7023925050250	7023925050350	7023925050450	11,10	50	7023925050950	12,80	50
Q8 RB 50 C/B	70239251501	70239251502	70239251503	70239251504	13,20	10	70239251509	15,20	10
	7023925150150	7023925150250	7023925150350	7023925150450	13,10	50	7023925150950	15,00	50
Q8 RBB 50 C/B	70239251701	70239251702	70239251703	70239251704	13,20	10	70239251709	15,20	10
	7023925170150	7023925170250	7023925170350	7023925170450	13,10	50	7023925170950	15,00	50
Q8 RBY 50 C/B	70239255501	70239255502	70239255503	70239255504	13,20	10	70239255509	15,20	10
	7023925550150	7023925550250	7023925550350	7023925550450	13,10	50	7023925550950	15,00	50
5									
Q8 RBWC Q6 50	70239238001	70239238002	70239238003	70239238004	16,20	10	70239238009	18,70	10
	7023923800150	7023923800250	7023923800350	7023923800450	16,00	50	7023923800950	18,50	50
Q8 RBWC Q8 50	70239238801	70239238802	70239238803	70239238804	16,20	10	70239238809	18,70	10
	7023923880150	7023923880250	7023923880350	7023923880450	16,00	50	7023923880950	18,50	50
6									
Q8 RBWC Q6 50 C/B	70239258001	70239258002	70239258003	70239258004	17,20	10	70239258009	19,70	10
	7023925800150	7023925800250	7023925800350	7023925800450	17,00	50	7023925800950	19,50	50
Q8 RBWC Q8 50 C/B	70239258801	70239258802	70239258803	70239258804	17,20	10	70239258809	19,70	10
	7023925880150	7023925880250	7023925880350	7023925880450	17,00	50	7023925880950	19,50	50
7									
Q8 PC 170x170	70239020001	70239020002	70239020003	70239020004	19,80	1	70239020009	22,80	1
Q8 PY85 170x170	70239020501	70239020502	70239020503	70239020504	19,80	1	70239020509	22,80	1



F1

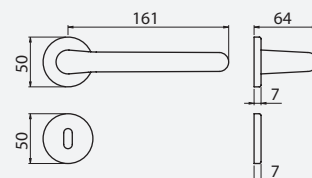

GCTOL



F1

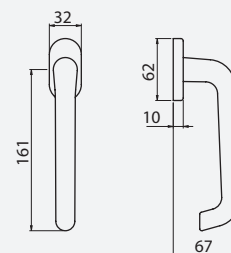
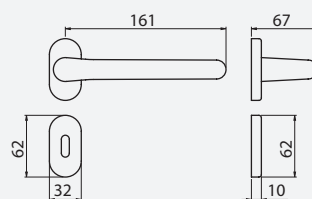

Finiture disponibili a richiesta:
Available finishings on request:

Bianco/*White* RAL 9010
Nero/*Black* RAL 9005 Lucido/*Bright*
Nero/*Black* RAL 9005 Opaco/*Matt*

	F1	€	Conf. pz.	GCTOL	€	Conf. pz.
Q8 RBY50 C/M	70240235001	16,50	1	70240235012	21,20	1
Guarnitura Q8 ros./bocc.yale con molla						
<i>Lever handle Q8 on rose-cyl escutcheon</i>	7024023500125	16,30	25	7024023501225	20,90	25

	F1	€	Conf. pz.	GCTOL	€	Conf. pz.
Q8 RBOYC C/M	70240225601	16,50	1	70240225612	21,20	1
Guarnitura Q8 ros./bocc.ovale yale con molla						
<i>Lever handle Q8 on oval rose-cyl escutcheon</i>	7024022560125	16,30	25	7024022561225	20,90	25

	F1	€	Conf. pz.	GCTOL	€	Conf. pz.
DK x 40	70240557001	7,70	20	70240557012	11,00	20
Martellina DK Q7 x 40						
<i>Window handle Q7 DK-tilt & turn handle</i>	7024055700150	7,50	100	7024055701250	10,80	100
DK x 40 C/BUSS.	70240558001	7,70	20	70240558012	11,00	20
Martellina DK Q7 x 40 con bussole D. 9,5						
<i>Window handle Q7 DK-tilt & turn handle with pins D. 9,5</i>	7024055800150	7,50	100	7024055801250	10,80	100

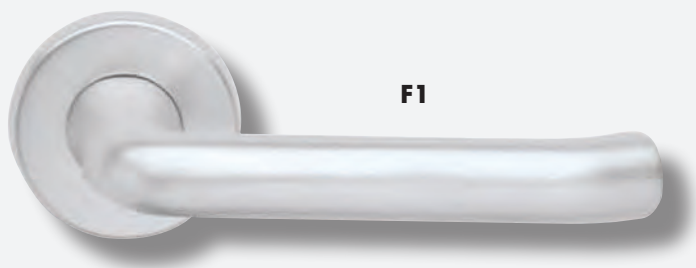

F1

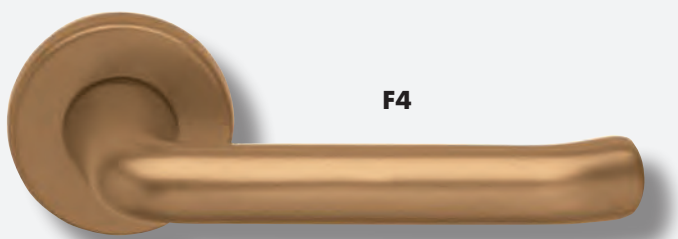

F4

1

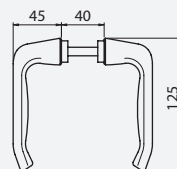

2

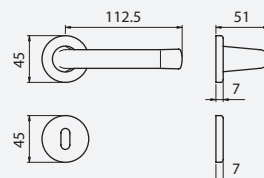

3

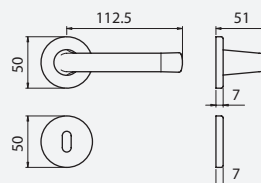

4

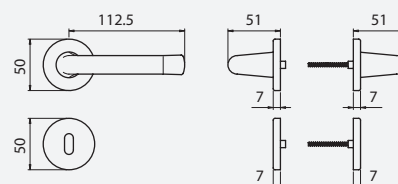

5

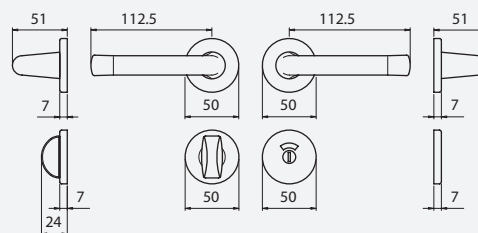

6

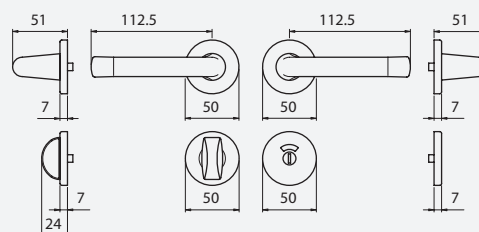

Finiture disponibili a richiesta:
Available finishings on request:

Bianco/White RAL 9010
Nero/Black RAL 9005 Lucido/Bright
Nero/Black RAL 9005 Opaco/Matt

1	F1	F2	F3	F4	€	Conf. pz.
Q8 BIL	70260208001	70260208002	70260208003	70260208004	7,00	10
	7026020800150	7026020800250	7026020800350	7026020800450	6,80	50
2						
Q8 R 45	70260280001	70260280002	70260280003	70260280004	8,80	10
	7026028000150	7026028000250	7026028000350	7026028000450	8,60	50
Q8 RB 45	70260281001	70260281002	70260281003	70260281004	10,60	10
	7026028100150	7026028100250	7026028100350	7026028100450	10,40	50
Q8 RBY 45	70260285001	70260285002	70260285003	70260285004	10,60	10
	7026028500150	7026028500250	7026028500350	7026028500450	10,40	50
3						
Q8 R 50	70260230001	70260230002	70260230003	70260230004	9,00	10
	7026023000150	7026023000250	7026023000350	7026023000450	8,80	50
Q8 RB 50	70260231001	70260231002	70260231003	70260231004	11,00	10
	7026023100150	7026023100250	7026023100350	7026023100450	10,80	50
Q8 RBB 50	70260231701	70260231702	70260231703	70260231704	11,00	10
	7026023170150	7026023170250	7026023170350	7026023170450	10,80	50
Q8 RBY 50	70260235001	70260235002	70260235003	70260235004	11,00	10
	7026023500150	7026023500250	7026023500350	7026023500450	10,80	50
4						
Q8 R 50 C/B	70260250501	70260250502	70260250503	70260250504	9,00	10
	7026025050150	7026025050250	7026025050350	7026025050450	8,80	50
Q8 RB 50 C/B	70260251501	70260251502	70260251503	70260251504	11,00	10
	7026025150150	7026025150250	7026025150350	7026025150450	10,80	50
Q8 RBB 50 C/B	70260251701	70260251702	70260251703	70260251704	11,00	10
	7026025170150	7026025170250	7026025170350	7026025170450	10,80	50
Q8 RBY 50 C/B	70260255501	70260255502	70260255503	70260255504	11,00	10
	7026025550150	7026025550250	7026025550350	7026025550450	10,80	50
5						
Q8 RBWC Q6 50	70260238001	70260238002	70260238003	70260238004	14,00	10
	7026023800150	7026023800250	7026023800350	7026023800450	13,80	50
Q8 RBWC Q8 50	70260238801	70260238802	70260238803	70260238804	14,00	10
	7026023880150	7026023880250	7026023880350	7026023880450	13,80	50
6						
Q8 RBWC Q6 50 C/B	70260258001	70260258002	70260258003	70260258004	14,90	10
	7026025800150	7026025800250	7026025800350	7026025800450	14,70	50
Q8 RBWC Q8 50 C/B	70260258801	70260258802	70260258803	70260258804	14,90	10
	7026025880150	7026025880250	7026025880350	7026025880450	14,70	50

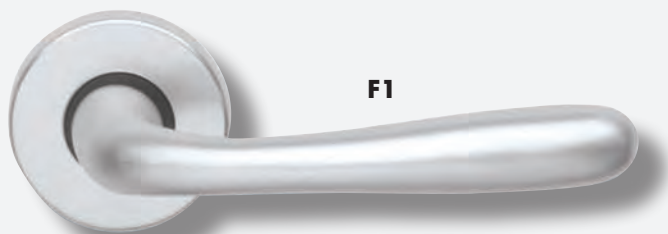

F1

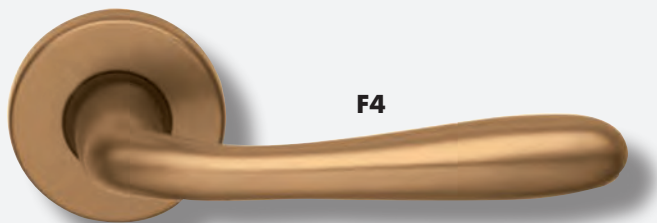

F4

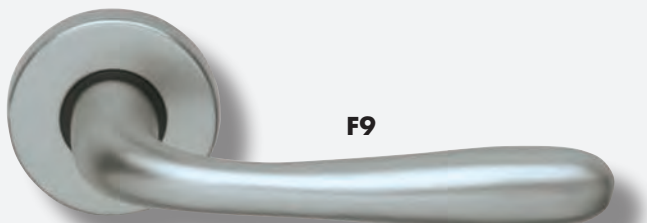

F9

1

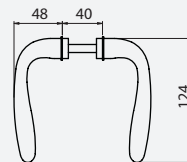

2

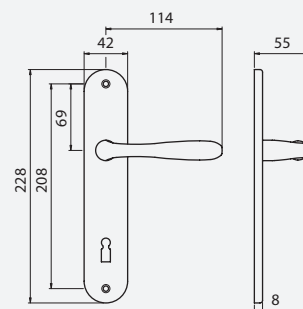

3

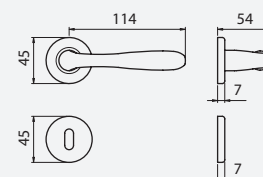

4

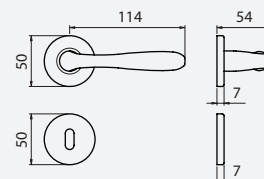

5

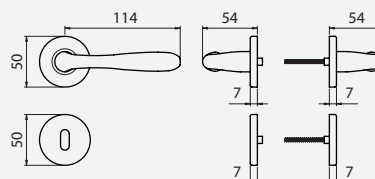

6

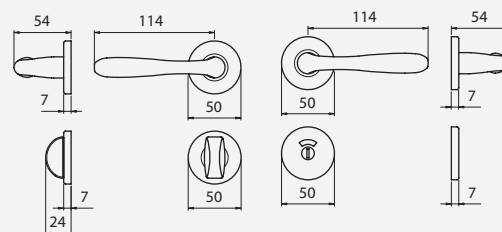

7

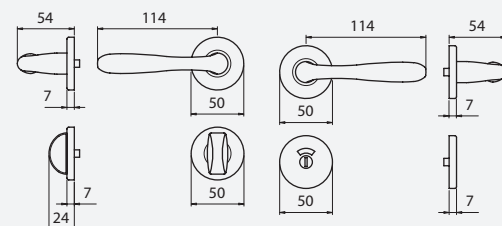

Finiture disponibili a richiesta:
 Available finishings on request:

Bianco/White RAL 9010
 Nero/Black RAL 9005 Lucido/Bright
 Nero/Black RAL 9005 Opaco/Matt

Martellina DK a pag.365
 Window handle pag.365

PELOPE - 1000

	F1	F2	F3	F4	€	Conf. pz.	F9	€	Conf. pz.
1 Q8 BIL	71000208001	71000208002	71000208003	71000208004	7,90	10	71000208009	9,10	10
	7100020800150	7100020800250	7100020800350	7100020800450	7,70	50	7100020800950	8,90	50
2 Q8 P90	71000089001	71000089002	71000089003	71000089004	10,90	10	71000089009	12,60	10
	7100008900150	7100008900250	7100008900350	7100008900450	10,80	50	7100008900950	12,40	50
Q8 P70	71000087001	71000087002	71000087003	71000087004	10,90	10	71000087009	12,60	10
	7100008700150	7100008700250	7100008700350	7100008700450	10,80	50	7100008700950	12,40	50
Q8 PY85	71000088501	71000088502	71000088503	71000088504	10,90	10	71000088509	12,60	10
	7100008850150	7100008850250	7100008850350	7100008850450	10,80	50	7100008850950	12,40	50
3 Q8 R 45	71000280001	71000280002	71000280003	71000280004	9,70	10	71000280009	11,10	10
	7100028000150	7100028000250	7100028000350	7100028000450	9,50	50	7100028000950	10,90	50
Q8 RB 45	71000281001	71000281002	71000281003	71000281004	11,40	10	71000281009	13,20	10
	7100028100150	7100028100250	7100028100350	7100028100450	11,30	50	7100028100950	13,00	50
Q8 RBY 45	71000285001	71000285002	71000285003	71000285004	11,40	10	71000285009	13,20	10
	7100028500150	7100028500250	7100028500350	7100028500450	11,30	50	7100028500950	13,00	50
4 Q8 R 50	71000230001	71000230002	71000230003	71000230004	9,90	10	71000230009	11,40	10
	7100023000150	7100023000250	7100023000350	7100023000450	9,70	50	7100023000950	11,20	50
Q8 RB 50	71000231001	71000231002	71000231003	71000231004	11,90	10	71000231009	13,70	10
	7100023100150	7100023100250	7100023100350	7100023100450	11,70	50	7100023100950	13,40	50
Q8 RBB 50	71000231701	71000231702	71000231703	71000231704	11,90	10	71000231709	13,70	10
	7100023170150	7100023170250	7100023170350	7100023170450	11,70	50	7100023170950	13,40	50
Q8 RBY 50	71000235001	71000235002	71000235003	71000235004	11,90	10	71000235009	13,70	10
	7100023500150	7100023500250	7100023500350	7100023500450	11,70	50	7100023500950	13,40	50
5 Q8 R 50 C/B	71000250501	71000250502	71000250503	71000250504	9,90	10	71000250509	11,40	10
	7100025050150	7100025050250	7100025050350	7100025050450	9,70	50	7100025050950	11,20	50
Q8 RB 50 C/B	71000251501	71000251502	71000251503	71000251504	11,90	10	71000251509	13,70	10
	7100025150150	7100025150250	7100025150350	7100025150450	11,70	50	7100025150950	13,40	50
Q8 RBB 50 C/B	71000251701	71000251702	71000251703	71000251704	11,90	10	71000251709	13,70	10
	7100025170150	7100025170250	7100025170350	7100025170450	11,70	50	7100025170950	13,40	50
Q8 RBY 50 C/B	71000255501	71000255502	71000255503	71000255504	11,90	10	71000255509	13,70	10
	7100025550150	7100025550250	7100025550350	7100025550450	11,70	50	7100025550950	13,40	50
6 Q8 RBWC Q6 50	71000238001	71000238002	71000238003	71000238004	14,90	10	71000238009	17,10	10
	7100023800150	7100023800250	7100023800350	7100023800450	14,60	50	7100023800950	16,90	50
Q8 RBWC Q8 50	71000238801	71000238802	71000238803	71000238804	14,90	10	71000238809	17,10	10
	7100023880150	7100023880250	7100023880350	7100023880450	14,60	50	7100023880950	16,90	50
7 Q8 RBWC Q6 50 C/B	71000258001	71000258002	71000258003	71000258004	15,80	10	71000258009	18,20	10
	7100025800150	7100025800250	7100025800350	7100025800450	15,60	50	7100025800950	18,00	50
Q8 RBWC Q8 50 C/B	71000258801	71000258802	71000258803	71000258804	15,80	10	71000258809	18,20	10
	7100025880150	7100025880250	7100025880350	7100025880450	15,60	50	7100025880950	18,00	50

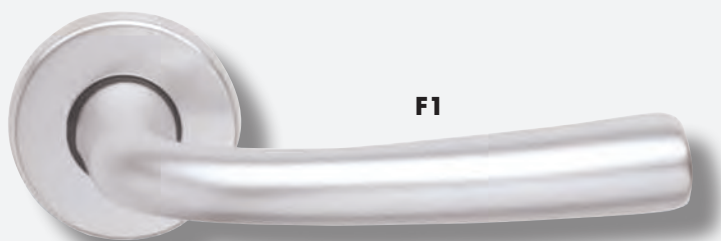

F1

1

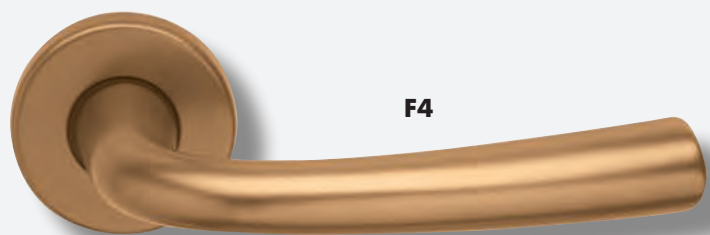
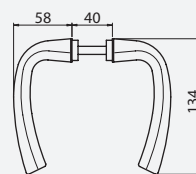

F4

2

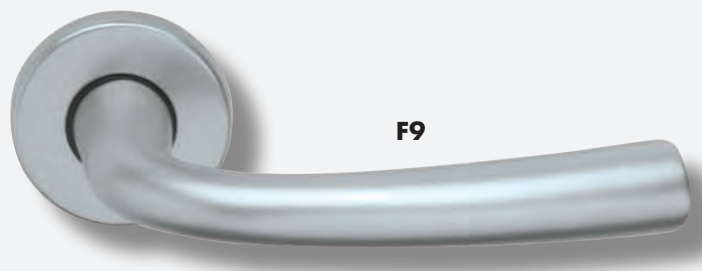
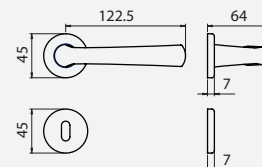

F9

3

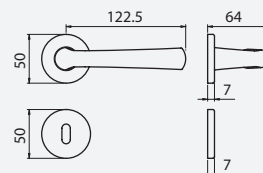

4

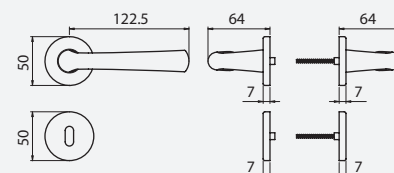

5

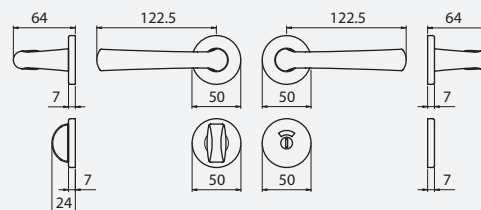

6

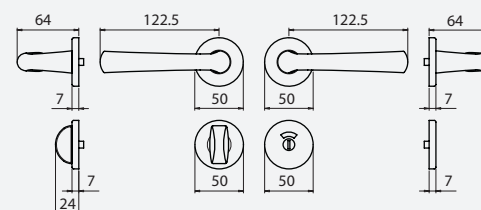

Finiture disponibili a richiesta:
Available finishings on request:

Bianco/White RAL 9010
Nero/Black RAL 9005 Lucido/Bright
Nero/Black RAL 9005 Opaco/Matt

1	F1	F2	F3	F4	€	Conf. pz.	F9	€	Conf. pz.
Q8 BIL	71050208001	71050208002	71050208003	71050208004	7,50	10	71050208009	8,60	10
	7105020800150	7105020800250	7105020800350	7105020800450	7,20	50	7105020800950	8,30	50
2									
Q8 R 45	71050280001	71050280002	71050280003	71050280004	9,20	10	71050280009	10,60	10
	7105028000150	7105028000250	7105028000350	7105028000450	9,00	50	7105028000950	10,40	50
Q8 RB 45	71050281001	71050281002	71050281003	71050281004	11,00	10	71050281009	12,70	10
	7105028100150	7105028100250	7105028100350	7105028100450	10,80	50	7105028100950	12,40	50
Q8 RBY 45	71050285001	71050285002	71050285003	71050285004	11,00	10	71050285009	12,70	10
	7105028500150	7105028500250	7105028500350	7105028500450	10,80	50	7105028500950	12,40	50
3									
Q8 R 50	71050230001	71050230002	71050230003	71050230004	9,40	10	71050230009	10,90	10
	7105023000150	7105023000250	7105023000350	7105023000450	9,20	50	7105023000950	10,70	50
Q8 RB 50	71050231001	71050231002	71050231003	71050231004	11,40	10	71050231009	13,10	10
	7105023100150	7105023100250	7105023100350	7105023100450	11,20	50	7105023100950	12,90	50
Q8 RBB 50	71050231701	71050231702	71050231703	71050231704	11,40	10	71050231709	13,10	10
	7105023170150	7105023170250	7105023170350	7105023170450	11,20	50	7105023170950	12,90	50
Q8 RBY 50	71050235001	71050235002	71050235003	71050235004	11,40	10	71050235009	13,10	10
	7105023500150	7105023500250	7105023500350	7105023500450	11,20	50	7105023500950	12,90	50
4									
Q8 R 50 C/B	71050250501	71050250502	71050250503	71050250504	9,40	10	71050250509	10,90	10
	7105025050150	7105025050250	7105025050350	7105025050450	9,20	50	7105025050950	10,70	50
Q8 RB 50 C/B	71050251501	71050251502	71050251503	71050251504	11,40	10	71050251509	13,10	10
	7105025150150	7105025150250	7105025150350	7105025150450	11,20	50	7105025150950	12,90	50
Q8 RBB 50 C/B	71050251701	71050251702	71050251703	71050251704	11,40	10	71050251709	13,10	10
	7105025170150	7105025170250	7105025170350	7105025170450	11,20	50	7105025170950	12,90	50
Q8 RBY 50 C/B	71050255501	71050255502	71050255503	71050255504	11,40	10	71050255509	13,10	10
	7105025550150	7105025550250	7105025550350	7105025550450	11,20	50	7105025550950	12,90	50
5									
Q8 RBWC Q6 50	71050238001	71050238002	71050238003	71050238004	14,40	10	71050238009	16,50	10
	7105023800150	7105023800250	7105023800350	7105023800450	14,20	50	7105023800950	16,40	50
Q8 RBWC Q8 50	71050238801	71050238802	71050238803	71050238804	14,40	10	71050238809	16,50	10
	7105023880150	7105023880250	7105023880350	7105023880450	14,20	50	7105023880950	16,40	50
6									
Q8 RBWC Q6 50 C/B	71050258001	71050258002	71050258003	71050258004	15,30	10	71050258009	17,60	10
	7105025800150	7105025800250	7105025800350	7105025800450	15,10	50	7105025800950	17,40	50
Q8 RBWC Q8 50 C/B	71050258801	71050258802	71050258803	71050258804	15,30	10	71050258809	17,60	10
	7105025880150	7105025880250	7105025880350	7105025880450	15,10	50	7105025880950	17,40	50

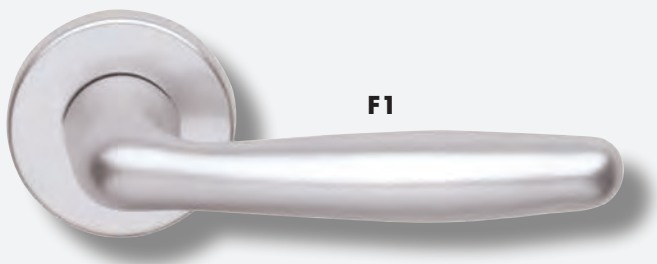

F1

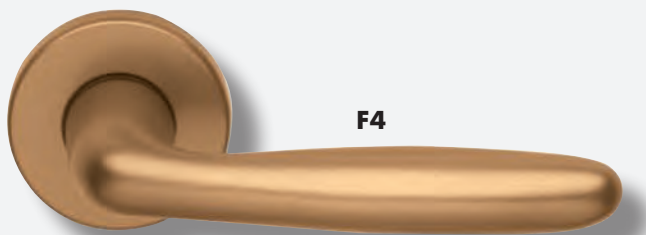

F4

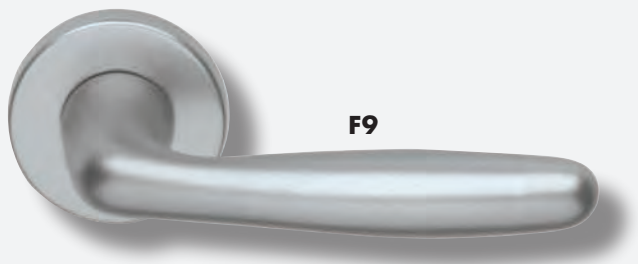

F9

1

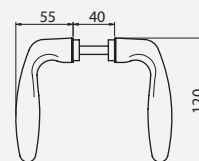

2

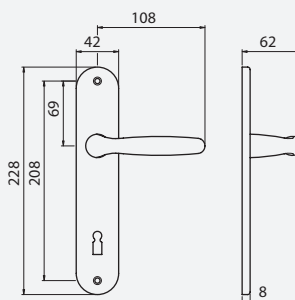

3

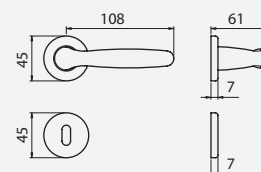

4

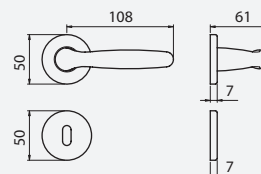

5

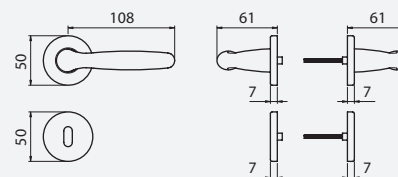

6

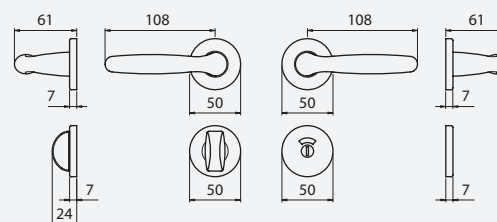

7

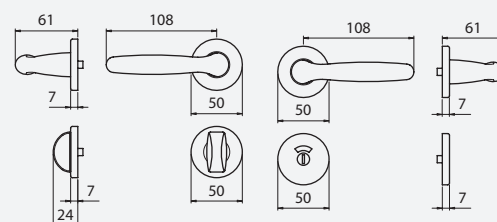

Finiture disponibili a richiesta:
 Available finishings on request:

Bianco/White RAL 9010
 Nero/Black RAL 9005 Lucido/Bright
 Nero/Black RAL 9005 Opaco/Matt

Martellina DK a pag.366
 Window handle pag.366

	F1	F2	F3	F4	€	Conf. pz.	F9	€	Conf. pz.
1 Q8 BIL	72005208001	72005208002	72005208003	72005208004	8,20	10	72005208009	9,50	10
	7200520800150	7200520800250	7200520800350	7200520800450	8,00	50	7200520800950	9,30	50
2 Q8 P90	72005089001	72005089002	72005089003	72005089004	11,30	10	72005089009	13,00	10
	7200508900150	7200508900250	7200508900350	7200508900450	11,10	50	7200508900950	12,80	50
Q8 P70	72005087001	72005087002	72005087003	72005087004	11,30	10	72005087009	13,00	10
	7200508700150	7200508700250	7200508700350	7200508700450	11,10	50	7200508700950	12,80	50
Q8 PY85	72005088501	72005088502	72005088503	72005088504	11,30	10	72005088509	13,00	10
	7200508850150	7200508850250	7200508850350	7200508850450	11,10	50	7200508850950	12,80	50
3 Q8 R 45	72005280001	72005280002	72005280003	72005280004	10,00	10	72005280009	11,60	10
	7200528000150	7200528000250	7200528000350	7200528000450	9,80	50	7200528000950	11,30	50
Q8 RB 45	72005281001	72005281002	72005281003	72005281004	11,80	10	72005281009	13,60	10
	7200528100150	7200528100250	7200528100350	7200528100450	11,60	50	7200528100950	13,40	50
Q8 RBY 45	72005285001	72005285002	72005285003	72005285004	11,80	10	72005285009	13,60	10
	7200528500150	7200528500250	7200528500350	7200528500450	11,60	50	7200528500950	13,40	50
4 Q8 R 50	72005230001	72005230002	72005230003	72005230004	10,20	10	72005230009	11,80	10
	7200523000150	7200523000250	7200523000350	7200523000450	10,00	50	7200523000950	11,60	50
Q8 RB 50	72005231001	72005231002	72005231003	72005231004	12,20	10	72005231009	14,10	10
	7200523100150	7200523100250	7200523100350	7200523100450	12,00	50	7200523100950	13,90	50
Q8 RBB 50	72005231701	72005231702	72005231703	72005231704	12,20	10	72005231709	14,10	10
	7200523170150	7200523170250	7200523170350	7200523170450	12,00	50	7200523170950	13,90	50
Q8 RBY 50	72005235001	72005235002	72005235003	72005235004	12,20	10	72005235009	14,10	10
	7200523500150	7200523500250	7200523500350	7200523500450	12,00	50	7200523500950	13,90	50
5 Q8 R 50 C/B	72005250501	72005250502	72005250503	72005250504	10,20	10	72005250509	11,80	10
	7200525050150	7200525050250	7200525050350	7200525050450	10,00	50	7200525050950	11,60	50
Q8 RB 50 C/B	72005251501	72005251502	72005251503	72005251504	12,20	10	72005251509	14,10	10
	7200525150150	7200525150250	7200525150350	7200525150450	12,00	50	7200525150950	13,90	50
Q8 RBB 50 C/B	72005251701	72005251702	72005251703	72005251704	12,20	10	72005251709	14,10	10
	7200525170150	7200525170250	7200525170350	7200525170450	12,00	50	7200525170950	13,90	50
Q8 RBY 50 C/B	72005255501	72005255502	72005255503	72005255504	12,20	10	72005255509	14,10	10
	7200525550150	7200525550250	7200525550350	7200525550450	12,00	50	7200525550950	13,90	50
6 Q8 RBWC Q6 50	72005238001	72005238002	72005238003	72005238004	15,20	10	72005238009	17,50	10
	7200523800150	7200523800250	7200523800350	7200523800450	15,00	50	7200523800950	17,30	50
Q8 RBWC Q8 50	72005238801	72005238802	72005238803	72005238804	15,20	10	72005238809	17,50	10
	7200523880150	7200523880250	7200523880350	7200523880450	15,00	50	7200523880950	17,30	50
7 Q8 RBWC Q6 50 C/B	72005258001	72005258002	72005258003	72005258004	16,10	10	72005258009	18,50	10
	7200525800150	7200525800250	7200525800350	7200525800450	15,90	50	7200525800950	18,30	50
Q8 RBWC Q8 50 C/B	72005258801	72005258802	72005258803	72005258804	16,10	10	72005258809	18,50	10
	7200525880150	7200525880250	7200525880350	7200525880450	15,90	50	7200525880950	18,30	50

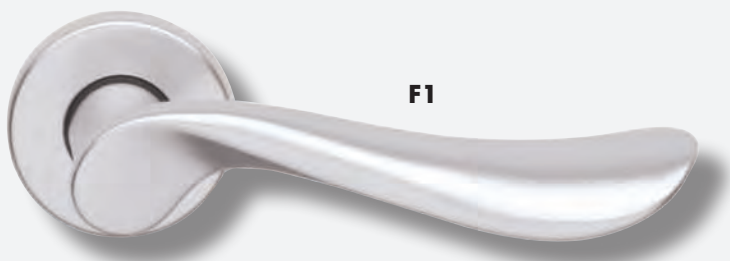

F1

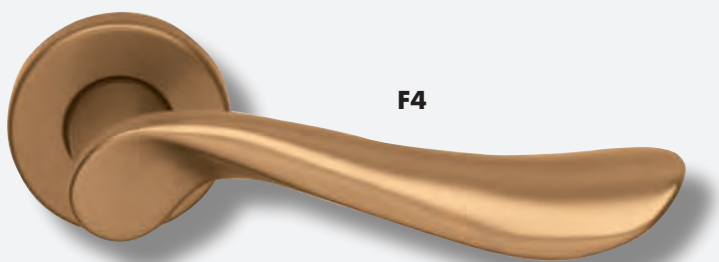

F4

1

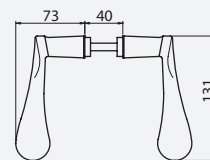

2

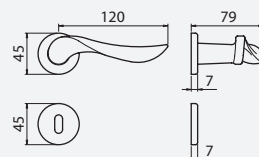

3

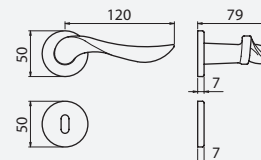

4

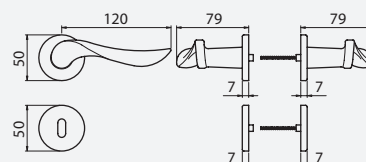

5

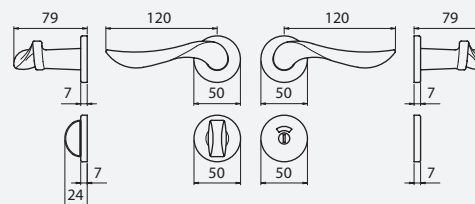

6

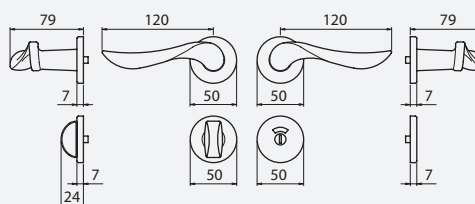

Finiture disponibili a richiesta:
Available finishings on request:

Bianco/White RAL 9010
Nero/Black RAL 9005 Lucido/Bright
Nero/Black RAL 9005 Opaco/Matt

1	F1	F2	F3	F4	€	Conf. pz.
Q8 BIL	72027208001	72027208002	72027208003	72027208004	8,80	10
	7202720800150	7202720800250	7202720800350	7202720800450	8,60	50
2						
Q8 R 45	72027280001	72027280002	72027280003	72027280004	10,60	10
	7202728000150	7202728000250	7202728000350	7202728000450	10,40	50
Q8 RB 45	72027281001	72027281002	72027281003	72027281004	12,40	10
	7202728100150	7202728100250	7202728100350	7202728100450	12,20	50
Q8 RBY 45	72027285001	72027285002	72027285003	72027285004	12,40	10
	7202728500150	7202728500250	7202728500350	7202728500450	12,20	50
3						
Q8 R 50	72027230001	72027230002	72027230003	72027230004	10,80	10
	7202723000150	7202723000250	7202723000350	7202723000450	10,60	50
Q8 RB 50	72027231001	72027231002	72027231003	72027231004	12,80	10
	7202723100150	7202723100250	7202723100350	7202723100450	12,60	50
Q8 RBB 50	72027231701	72027231702	72027231703	72027231704	12,80	10
	7202723170150	7202723170250	7202723170350	7202723170450	12,60	50
Q8 RBY 50	72027235001	72027235002	72027235003	72027235004	12,80	10
	7202723500150	7202723500250	7202723500350	7202723500450	12,60	50
4						
Q8 R 50 C/B	72027250501	72027250502	72027250503	72027250504	10,80	10
	7202725050150	7202725050250	7202725050350	7202725050450	10,60	50
Q8 RB 50 C/B	72027251501	72027251502	72027251503	72027251504	12,80	10
	7202725150150	7202725150250	7202725150350	7202725150450	12,60	50
Q8 RBB 50 C/B	72027251701	72027251702	72027251703	72027251704	12,80	10
	7202725170150	7202725170250	7202725170350	7202725170450	12,60	50
Q8 RBY 50 C/B	72027255501	72027255502	72027255503	72027255504	12,80	10
	7202725550150	7202725550250	7202725550350	7202725550450	12,60	50
5						
Q8 RBWC Q6 50	72027238001	72027238002	72027238003	72027238004	15,80	10
	7202723800150	7202723800250	7202723800350	7202723800450	15,60	50
Q8 RBWC Q8 50	72027238801	72027238802	72027238803	72027238804	15,80	10
	7202723880150	7202723880250	7202723880350	7202723880450	15,60	50
6						
Q8 RBWC Q6 50 C/B	72027258001	72027258002	72027258003	72027258004	16,70	10
	7202725800150	7202725800250	7202725800350	7202725800450	16,50	50
Q8 RBWC Q8 50 C/B	72027258801	72027258802	72027258803	72027258804	16,70	10
	7202725880150	7202725880250	7202725880350	7202725880450	16,50	50



F1



F4

1

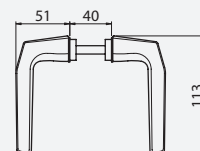

2

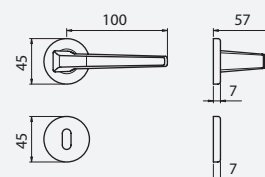

3

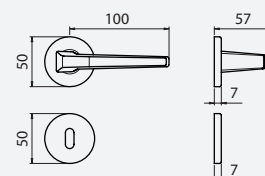

4

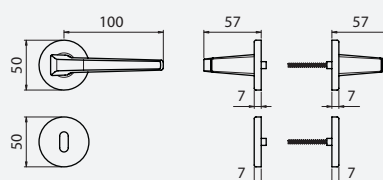

5

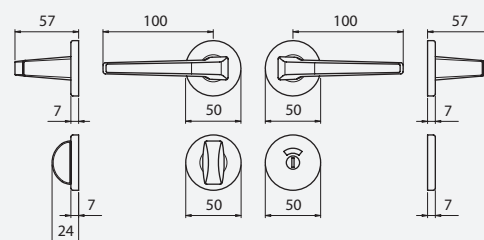

6

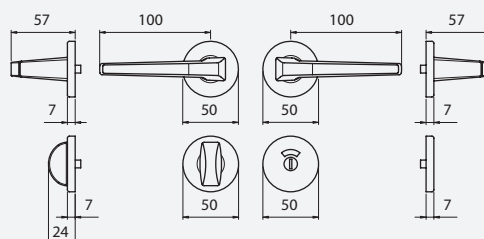

Finiture disponibili a richiesta:
Available finishings on request:

Bianco/White RAL 9010
Nero/Black RAL 9005 Lucido/Bright
Nero/Black RAL 9005 Opaco/Matt

1	F1	F2	F3	F4	€	Conf. pz.
Q8 BIL	72100208001	72100208002	72100208003	72100208004	6,90	10
	7210020800150	7210020800250	7210020800350	7210020800450	6,70	50
2						
Q8 R 45	72100280001	72100280002	72100280003	72100280004	8,70	10
	7210028000150	7210028000250	7210028000350	7210028000450	8,50	50
Q8 RB 45	72100281001	72100281002	72100281003	72100281004	10,40	10
	7210028100150	7210028100250	7210028100350	7210028100450	10,30	50
Q8 RBY 45	72100285001	72100285002	72100285003	72100285004	10,40	10
	7210028500150	7210028500250	7210028500350	7210028500450	10,30	50
3						
Q8 R 50	72100230001	72100230002	72100230003	72100230004	8,90	10
	7210023000150	7210023000250	7210023000350	7210023000450	8,70	50
Q8 RB 50	72100231001	72100231002	72100231003	72100231004	10,90	10
	7210023100150	7210023100250	7210023100350	7210023100450	10,70	50
Q8 RBB 50	72100231701	72100231702	72100231703	72100231704	10,90	10
	7210023170150	7210023170250	7210023170350	7210023170450	10,70	50
Q8 RBY 50	72100235001	72100235002	72100235003	72100235004	10,90	10
	7210023500150	7210023500250	7210023500350	7210023500450	10,70	50
4						
Q8 R 50 C/B	72100250501	72100250502	72100250503	72100250504	8,90	10
	7210025050150	7210025050250	7210025050350	7210025050450	8,70	50
Q8 RB 50 C/B	72100251501	72100251502	72100251503	72100251504	10,90	10
	7210025150150	7210025150250	7210025150350	7210025150450	10,70	50
Q8 RBB 50 C/B	72100251701	72100251702	72100251703	72100251704	10,90	10
	7210025170150	7210025170250	7210025170350	7210025170450	10,70	50
Q8 RBY 50 C/B	72100255501	72100255502	72100255503	72100255504	10,90	10
	7210025550150	7210025550250	7210025550350	7210025550450	10,70	50
5						
Q8 RBWC Q6 50	72100238001	72100238002	72100238003	72100238004	13,90	10
	7210023800150	7210023800250	7210023800350	7210023800450	13,70	50
Q8 RBWC Q8 50	72100238801	72100238802	72100238803	72100238804	13,90	10
	7210023880150	7210023880250	7210023880350	7210023880450	13,70	50
6						
Q8 RBWC Q6 50 C/B	72100258001	72100258002	72100258003	72100258004	14,80	10
	7210025800150	7210025800250	7210025800350	7210025800450	14,60	50
Q8 RBWC Q8 50 C/B	72100258801	72100258802	72100258803	72100258804	14,80	10
	7210025880150	7210025880250	7210025880350	7210025880450	14,60	50



F1

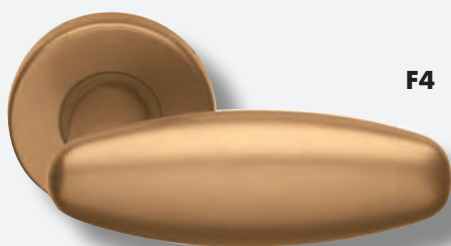

F4

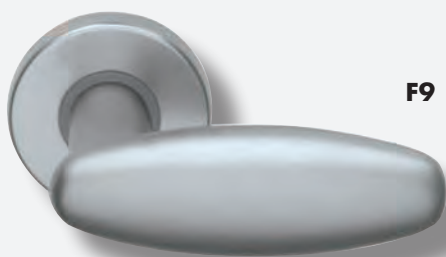

F9

Finiture disponibili a richiesta:
Available finishings on request:

Bianco/White RAL 9010
Nero/Black RAL 9005 Lucido/Bright
Nero/Black RAL 9005 Opaco/Matt

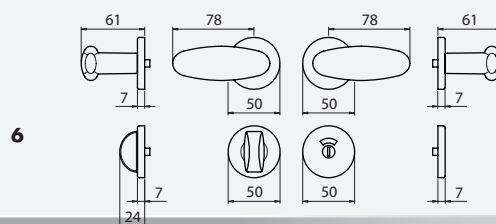
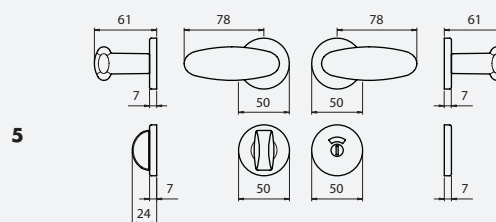
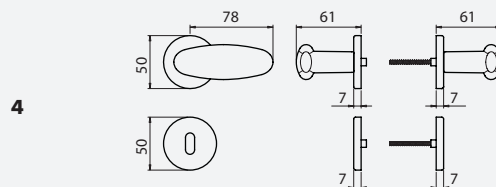
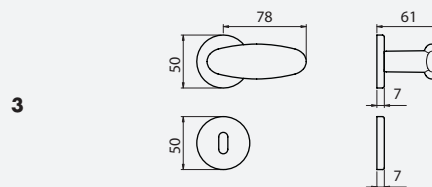
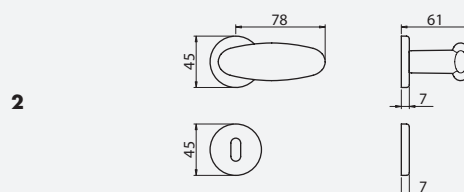
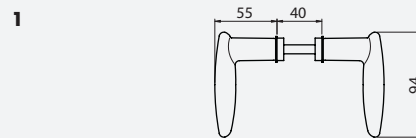

1	F1	F2	F3	F4	€	Conf. pz.	F9	€	Conf. pz.
Q8 BIL	77440208001	77440208002	77440208003	77440208004	9,60	10	77440208009	11,10	10
	7744020800150	7744020800250	7744020800350	7744020800450	9,40	50	7744020800950	10,90	50
2									
Q8 R 45	77440280001	77440280002	77440280003	77440280004	11,40	10	77440280009	13,10	10
	7744028000150	7744028000250	7744028000350	7744028000450	11,20	50	7744028000950	12,90	50
Q8 RB 45	77440281001	77440281002	77440281003	77440281004	13,20	10	77440281009	15,20	10
	7744028100150	7744028100250	7744028100350	7744028100450	13,00	50	7744028100950	15,00	50
Q8 RBY 45	77440285001	77440285002	77440285003	77440285004	13,20	10	77440285009	15,20	10
	7744028500150	7744028500250	7744028500350	7744028500450	13,00	50	7744028500950	15,00	50
3									
Q8 R 50	77440230001	77440230002	77440230003	77440230004	11,60	10	77440230009	13,40	10
	7744023000150	7744023000250	7744023000350	7744023000450	11,40	50	7744023000950	13,20	50
Q8 RB 50	77440231001	77440231002	77440231003	77440231004	13,60	10	77440231009	15,60	10
	7744023100150	7744023100250	7744023100350	7744023100450	13,40	50	7744023100950	15,40	50
Q8 RBB 50	77440231701	77440231702	77440231703	77440231704	13,60	10	77440231709	15,60	10
	7744023170150	7744023170250	7744023170350	7744023170450	13,40	50	7744023170950	15,40	50
Q8 RBY 50	77440235001	77440235002	77440235003	77440235004	13,60	10	77440235009	15,60	10
	7744023500150	7744023500250	7744023500350	7744023500450	13,40	50	7744023500950	15,40	50
4									
Q8 R 50 C/B	77440250501	77440250502	77440250503	77440250504	11,60	10	77440250509	13,40	10
	7744025050150	7744025050250	7744025050350	7744025050450	11,40	50	7744025050950	13,20	50
Q8 RB 50 C/B	77440251501	77440251502	77440251503	77440251504	13,60	10	77440251509	15,60	10
	7744025150150	7744025150250	7744025150350	7744025150450	13,40	50	7744025150950	15,40	50
Q8 RBB 50 C/B	77440251701	77440251702	77440251703	77440251704	13,60	10	77440251709	15,60	10
	7744025170150	7744025170250	7744025170350	7744025170450	13,40	50	7744025170950	15,40	50
Q8 RBY 50 C/B	77440255501	77440255502	77440255503	77440255504	13,60	10	77440255509	15,60	10
	7744025550150	7744025550250	7744025550350	7744025550450	13,40	50	7744025550950	15,40	50
5									
Q8 RBWC Q6 50	77440238001	77440238002	77440238003	77440238004	16,50	10	77440238009	19,10	10
	7744023800150	7744023800250	7744023800350	7744023800450	16,40	50	7744023800950	18,90	50
Q8 RBWC Q8 50	77440238801	77440238802	77440238803	77440238804	16,50	10	77440238809	19,10	10
	7744023880150	7744023880250	7744023880350	7744023880450	16,40	50	7744023880950	18,90	50
6									
Q8 RBWC Q6 50 C/B	77440258001	77440258002	77440258003	77440258004	17,50	10	77440258009	20,10	10
	7744025800150	7744025800250	7744025800350	7744025800450	17,30	50	7744025800950	20,00	50
Q8 RBWC Q8 50 C/B	77440258801	77440258802	77440258803	77440258804	17,50	10	77440258809	20,10	10
	7744025880150	7744025880250	7744025880350	7744025880450	17,30	50	7744025880950	20,00	50



F1

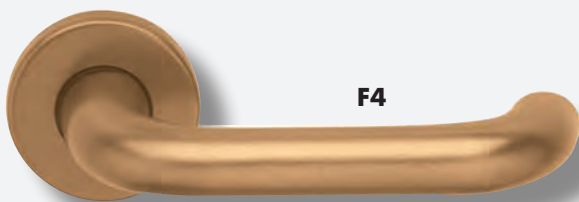

F4

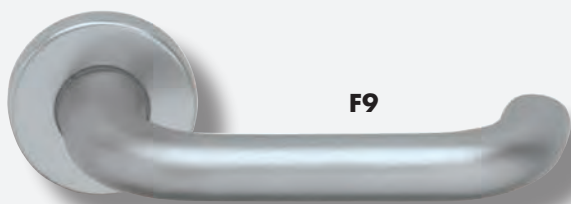

F9

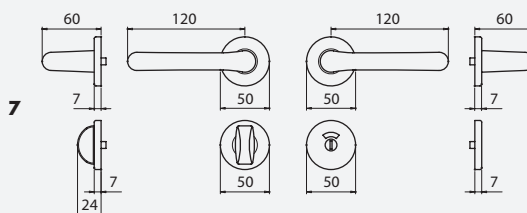
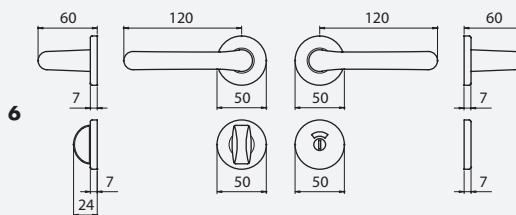
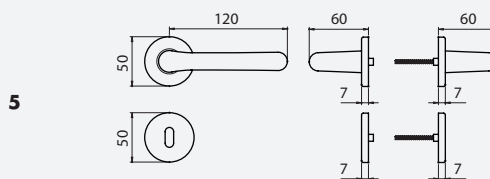
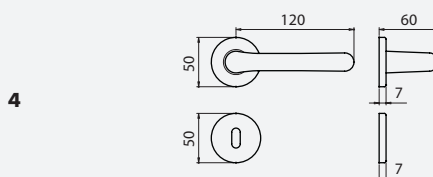
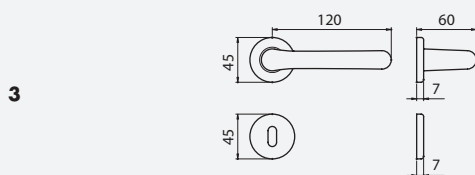
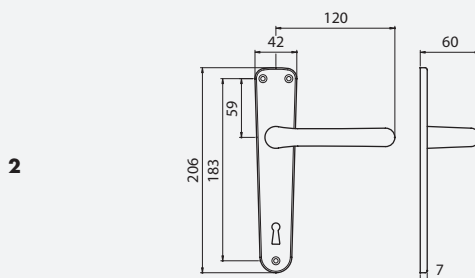
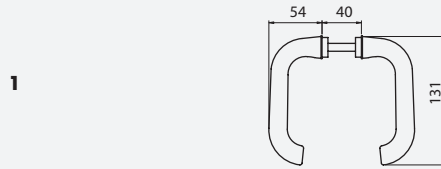

Finiture disponibili a richiesta:
 Available finishings on request:

Bianco/White RAL 9010
 Nero/Black RAL 9005 Lucido/Bright
 Nero/Black RAL 9005 Opaco/Matt

EUROPA 238

	F1	F2	F3	F4	€	Conf. pz.	F9	€	Conf. pz.
1 Q8 BIL	70238208001	70238208002	70238208003	70238208004	7,70	10	70238208009	8,90	10
	7023820800150	7023820800250	7023820800350	7023820800450	7,50	50	7023820800950	8,70	50
2 Q8 P90	70238089001	70238089002	70238089003	70238089004	10,60	10	70238089009	12,10	10
	7023808900150	7023808900250	7023808900350	7023808900450	10,30	50	7023808900950	11,90	50
Q8 P70	70238087001	70238087002	70238087003	70238087004	10,60	10	70238087009	12,10	10
	7023808700150	7023808700250	7023808700350	7023808700450	10,30	50	7023808700950	11,90	50
Q8 PY85	70238088501	70238088502	70238088503	70238088504	10,60	10	70238088509	12,10	10
	7023808850150	7023808850250	7023808850350	7023808850450	10,30	50	7023808850950	11,90	50
3 Q8 R 45	70238280001	70238280002	70238280003	70238280004	9,50	10	70238280009	10,90	10
	7023828000150	7023828000250	7023828000350	7023828000450	9,30	50	7023828000950	10,80	50
Q8 RB 45	70238281001	70238281002	70238281003	70238281004	11,30	10	70238281009	13,00	10
	7023828100150	7023828100250	7023828100350	7023828100450	11,10	50	7023828100950	12,80	50
Q8 RBY 45	70238285001	70238285002	70238285003	70238285004	11,30	10	70238285009	13,00	10
	7023828500150	7023828500250	7023828500350	7023828500450	11,10	50	7023828500950	12,80	50
4 Q8 R 50	70238230001	70238230002	70238230003	70238230004	9,70	10	70238230009	11,10	10
	7023823000150	7023823000250	7023823000350	7023823000450	9,50	50	7023823000950	10,90	50
Q8 RB 50	70238231001	70238231002	70238231003	70238231004	11,70	10	70238231009	13,40	10
	7023823100150	7023823100250	7023823100350	7023823100450	11,40	50	7023823100950	13,20	50
Q8 RBB 50	70238231701	70238231702	70238231703	70238231704	11,70	10	70238231709	13,40	10
	7023823170150	7023823170250	7023823170350	7023823170450	11,40	50	7023823170950	13,20	50
Q8 RBY 50	70238235001	70238235002	70238235003	70238235004	11,70	10	70238235009	13,40	10
	7023823500150	7023823500250	7023823500350	7023823500450	11,40	50	7023823500950	13,20	50
5 Q8 R 50 C/B	70238250501	70238250502	70238250503	70238250504	9,70	10	70238250509	11,10	10
	7023825050150	7023825050250	7023825050350	7023825050450	9,50	50	7023825050950	10,90	50
Q8 RB 50 C/B	70238251501	70238251502	70238251503	70238251504	11,70	10	70238251509	13,40	10
	7023825150150	7023825150250	7023825150350	7023825150450	11,40	50	7023825150950	13,20	50
Q8 RBB 50 C/B	70238251701	70238251702	70238251703	70238251704	11,70	10	70238251709	13,40	10
	7023825170150	7023825170250	7023825170350	7023825170450	11,40	50	7023825170950	13,20	50
Q8 RBY 50 C/B	70238255501	70238255502	70238255503	70238255504	11,70	10	70238255509	13,40	10
	7023825550150	7023825550250	7023825550350	7023825550450	11,40	50	7023825550950	13,20	50
6 Q8 RBWC Q6 50	70238238001	70238238002	70238238003	70238238004	14,60	10	70238238009	16,90	10
	7023823800150	7023823800250	7023823800350	7023823800450	14,40	50	7023823800950	16,70	50
Q8 RBWC Q8 50	70238238801	70238238802	70238238803	70238238804	14,60	10	70238238809	16,90	10
	7023823880150	7023823880250	7023823880350	7023823880450	14,40	50	7023823880950	16,70	50
7 Q8 RBWC Q6 50 C/B	70238258001	70238258002	70238258003	70238258004	15,60	10	70238258009	18,00	10
	7023825800150	7023825800250	7023825800350	7023825800450	15,40	50	7023825800950	17,70	50
Q8 RBWC Q8 50 C/B	70238258801	70238258802	70238258803	70238258804	15,60	10	70238258809	18,00	10
	7023825880150	7023825880250	7023825880350	7023825880450	15,40	50	7023825880950	17,70	50



F1

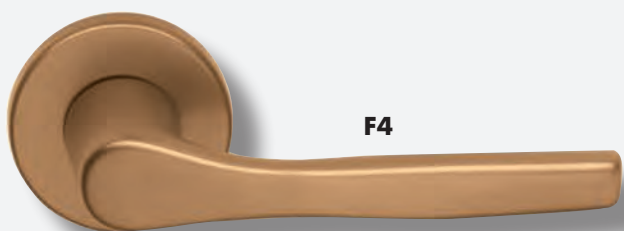

F4

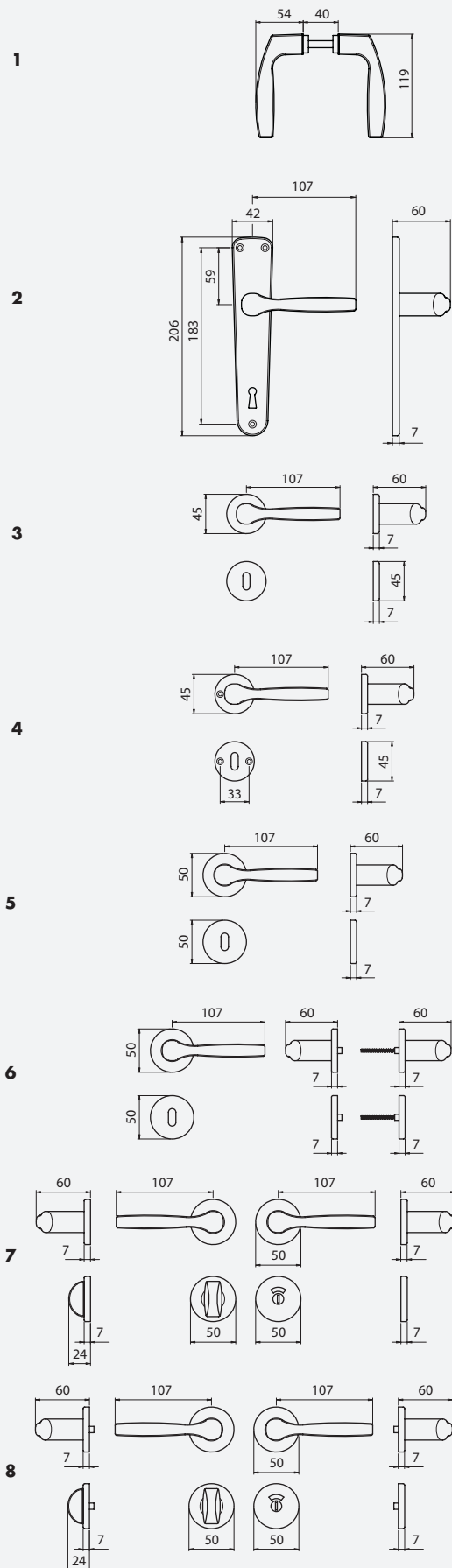

Finiture disponibili a richiesta:
 Available finishings on request:

Bianco/White RAL 9010
 Nero/Black RAL 9005 Lucido/Bright
 Nero/Black RAL 9005 Opaco/Matt

Martellina DK a pag.366
 Window handle pag.366

		F1	F2	F3	F4	€	Conf. pz.
1	Q8 BIL	77400208001	77400208002	77400208003	77400208004	5,80	10
		7740020800150	7740020800250	7740020800350	7740020800450	5,60	50
2	Q8 P90	77400089001	77400089002	77400089003	77400089004	8,60	10
		7740008900150	7740008900250	7740008900350	7740008900450	8,40	50
	Q8 P70	77400087001	77400087002	77400087003	77400087004	8,60	10
		7740008700150	7740008700250	7740008700350	7740008700450	8,40	50
	Q8 PY85	77400088501	77400088502	77400088503	77400088504	8,60	10
		7740008850150	7740008850250	7740008850350	7740008850450	8,40	50
	Q8 P90 fissa	7740008900153	7740008900253	7740008900353	7740008900453	8,60	5
	Q8 P70 fissa	7740008700153	7740008700253	7740008700353	7740008700453	8,60	5
	Q8 PY85 fissa	7740008850153	7740008850253	7740008850353	7740008850453	8,60	5
3	Q8 R 45	77400280001	77400280002	77400280003	77400280004	7,60	10
		7740028000150	7740028000250	7740028000350	7740028000450	7,40	50
	Q8 RB 45	77400281001	77400281002	77400281003	77400281004	9,30	10
		7740028100150	7740028100250	7740028100350	7740028100450	9,10	50
	Q8 RBY 45	77400285001	77400285002	77400285003	77400285004	9,30	10
		7740028500150	7740028500250	7740028500350	7740028500450	9,10	50
4	Q8 R 45 VV	77400250001	77400250002	77400250003	77400250004	7,40	10
		7740025000150	7740025000250	7740025000350	7740025000450	7,10	50
	Q8 RB 45 VV	77400251001	77400251002	77400251003	77400251004	9,00	10
		7740025100150	7740025100250	7740025100350	7740025100450	8,80	50
	Q8 RBY 45 VV	77400255001	77400255002	77400255003	77400255004	9,00	10
		7740025500150	7740025500250	7740025500350	7740025500450	8,80	50
5	Q8 R 50	77400230001	77400230002	77400230003	77400230004	7,80	10
		7740023000150	7740023000250	7740023000350	7740023000450	7,60	50
	Q8 RB 50	77400231001	77400231002	77400231003	77400231004	9,80	10
		7740023100150	7740023100250	7740023100350	7740023100450	9,60	50
	Q8 RBB 50	77400231701	77400231702	77400231703	77400231704	9,80	10
		7740023170150	7740023170250	7740023170350	7740023170450	9,60	50
	Q8 RBY 50	77400235001	77400235002	77400235003	77400235004	9,80	10
		7740023500150	7740023500250	7740023500350	7740023500450	9,60	50
6	Q8 R 50 C/B	77400250501	77400250502	77400250503	77400250504	7,80	10
		7740025050150	7740025050250	7740025050350	7740025050450	7,60	50
	Q8 RB 50 C/B	77400251501	77400251502	77400251503	77400251504	9,80	10
		7740025150150	7740025150250	7740025150350	7740025150450	9,60	50
	Q8 RBB 50 C/B	77400251701	77400251702	77400251703	77400251704	9,80	10
		7740025170150	7740025170250	7740025170350	7740025170450	9,60	50
	Q8 RBY 50 C/B	77400255501	77400255502	77400255503	77400255504	9,80	10
		7740025550150	7740025550250	7740025550350	7740025550450	9,60	50
7	Q8 RBWC Q6 50	77400238001	77400238002	77400238003	77400238004	12,70	10
		7740023800150	7740023800250	7740023800350	7740023800450	12,50	50
	Q8 RBWC Q8 50	77400238801	77400238802	77400238803	77400238804	12,70	10
		7740023880150	7740023880250	7740023880350	7740023880450	12,50	50
8	Q8 RBWC Q6 50 C/B	77400258001	77400258002	77400258003	77400258004	13,70	10
		7740025800150	7740025800250	7740025800350	7740025800450	13,40	50
	Q8 RBWC Q8 50 C/B	77400258801	77400258802	77400258803	77400258804	13,70	10
		7740025880150	7740025880250	7740025880350	7740025880450	13,40	50



F1



F4

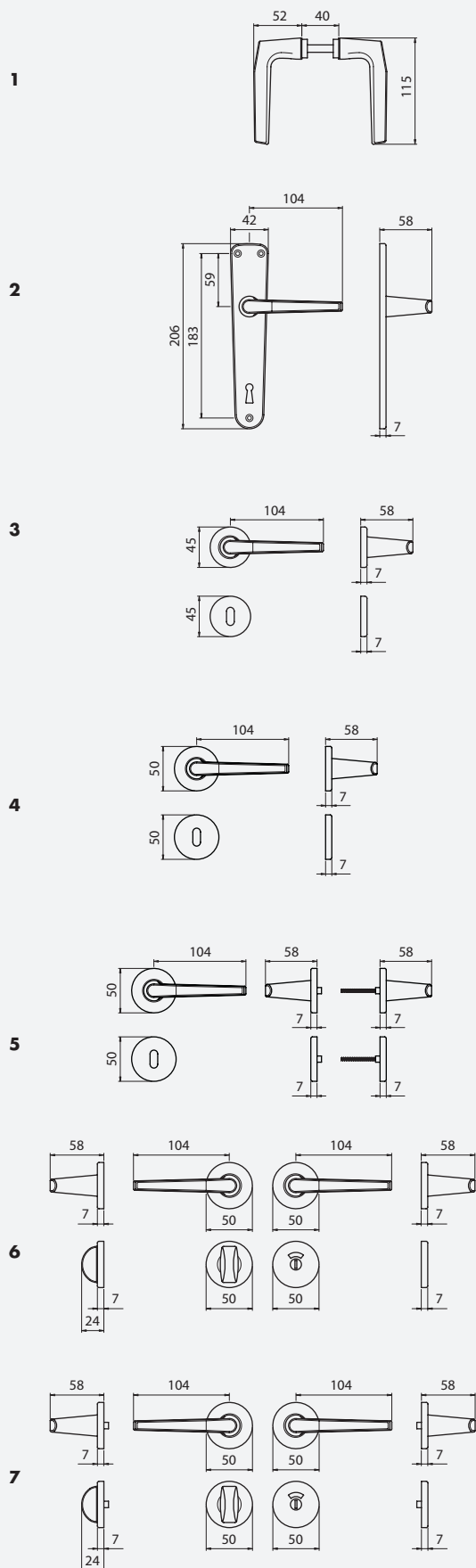

Finiture disponibili a richiesta:
 Available finishings on request:

Bianco/White RAL 9010
 Nero/Black RAL 9005 Lucido/Bright
 Nero/Black RAL 9005 Opaco/Matt

JOLLY - 210

	F1	F2	F3	F4	€	Conf. pz.	
1	Q8 BIL	70210208001	70210208002	70210208003	70210208004	5,90	10
		7021020800150	7021020800250	7021020800350	7021020800450	5,70	50
2	Q8 P90	70210089001	70210089002	70210089003	70210089004	8,80	10
		7021008900150	7021008900250	7021008900350	7021008900450	8,60	50
	Q8 P70	70210087001	70210087002	70210087003	70210087004	8,80	10
		7021008700150	7021008700250	7021008700350	7021008700450	8,60	50
	Q8 PY85	70210088501	70210088502	70210088503	70210088504	8,80	10
		7021008850150	7021008850250	7021008850350	7021008850450	8,60	50
3	Q8 R 45	70210280001	70210280002	70210280003	70210280004	7,70	10
		7021028000150	7021028000250	7021028000350	7021028000450	7,50	50
	Q8 RB 45	70210281001	70210281002	70210281003	70210281004	9,50	10
		7021028100150	7021028100250	7021028100350	7021028100450	9,30	50
	Q8 RBY 45	70210285001	70210285002	70210285003	70210285004	9,50	10
		7021028500150	7021028500250	7021028500350	7021028500450	9,30	50
4	Q8 R 50	70210230001	70210230002	70210230003	70210230004	7,90	10
		7021023000150	7021023000250	7021023000350	7021023000450	7,70	50
	Q8 RB 50	70210231001	70210231002	70210231003	70210231004	9,90	10
		7021023100150	7021023100250	7021023100350	7021023100450	9,70	50
	Q8 RBB 50	70210231701	70210231702	70210231703	70210231704	9,90	10
		7021023170150	7021023170250	7021023170350	7021023170450	9,70	50
	Q8 RBY 50	70210235001	70210235002	70210235003	70210235004	9,90	10
		7021023500150	7021023500250	7021023500350	7021023500450	9,70	50
5	Q8 R 50 C/B	70210250501	70210250502	70210250503	70210250504	7,90	10
		7021025050150	7021025050250	7021025050350	7021025050450	7,70	50
	Q8 RB 50 C/B	70210251501	70210251502	70210251503	70210251504	9,90	10
		7021025150150	7021025150250	7021025150350	7021025150450	9,70	50
	Q8 RBB 50 C/B	70210251701	70210251702	70210251703	70210251704	9,90	10
		7021025170150	7021025170250	7021025170350	7021025170450	9,70	50
	Q8 RBY 50 C/B	70210255501	70210255502	70210255503	70210255504	9,90	10
		7021025550150	7021025550250	7021025550350	7021025550450	9,70	50
6	Q8 RBWC Q6 50	70210238001	70210238002	70210238003	70210238004	12,90	10
		7021023800150	7021023800250	7021023800350	7021023800450	12,70	50
	Q8 RBWC Q8 50	70210238801	70210238802	70210238803	70210238804	12,90	10
		7021023880150	7021023880250	7021023880350	7021023880450	12,70	50
7	Q8 RBWC Q6 50 C/B	70210258001	70210258002	70210258003	70210258004	13,80	10
		7021025800150	7021025800250	7021025800350	7021025800450	13,60	50
	Q8 RBWC Q8 50 C/B	70210258801	70210258802	70210258803	70210258804	13,80	10
		7021025880150	7021025880250	7021025880350	7021025880450	13,60	50

VIENNA

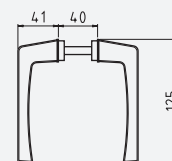
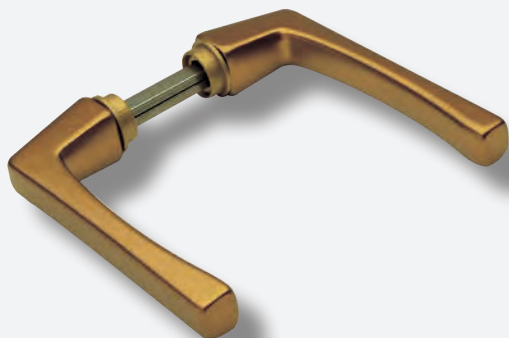

	F1	F2	F3	F4	€	Conf. pz.
Q8 BIL	77416208001	77416208002	77416208003	77416208004	7,20	10

ERIKA

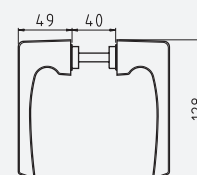
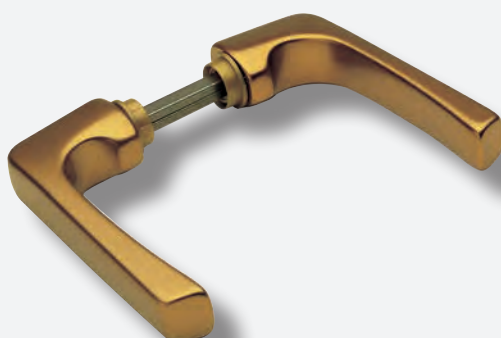

	F1	F2	F3	F4	€	Conf. pz.
Q8 BIL	77410208001	77410208002	77410208003	77410208004	9,40	10

MIGNON

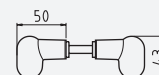
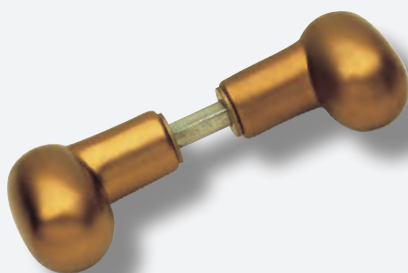

	F1	F2	F3	F4	€	Conf. pz.
Q6 BIL	77466208001	77466208002	77466208003	77466208004	6,80	10

2071

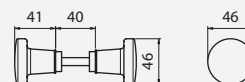
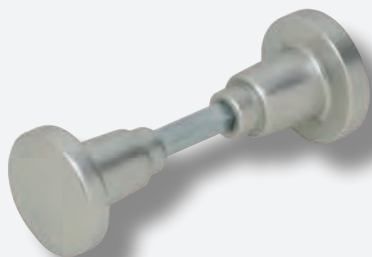

	F1	F2	F3	F4	€	Conf. pz.	F9	€	Conf. pz.
Q8 BIL	72071208001	72071208002	72071208003	72071208004	10,60	50	72071208009	12,00	50

CUORE - 2006

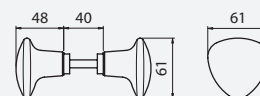
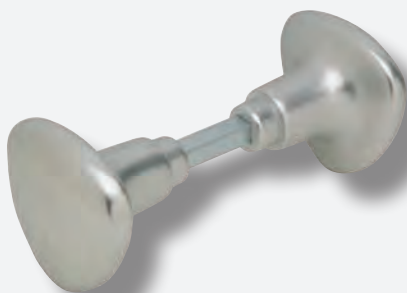

	F1	F2	F3	F4	€	Conf. pz.
Q8 BIL	72006208001	72006208002	72006208003	72006208004	10,90	50



ROSETTE E BOCCHETTE



	F1	F2	F3	F4	€	F9	€
COPPIA ROS.Q 50x50 F.18	77498554001	77498554002	77498554003	77498554004	3,30	77498554009	3,80
COPPIA BOC.Q 50x50 PAT	77498651101	77498651102	77498651103	77498651104	3,30	77498651109	3,80
COPPIA BOC.Q 50x50 YALE	77498655101	77498655102	77498655103	77498655104	3,30	77498655109	3,80
COPPIA ROS.Q 50x50 F.18 C/BUSS	77498551301	77498551302	77498551303	77498551304	3,30	77498551309	3,80
COPPIA BOC.Q 50x50 PAT C/BUSS	77498651301	77498651302	77498651303	77498651304	3,30	77498651309	3,80
COPPIA BOC.Q 50x50 YALE C/BUSS	77498655301	77498655302	77498655303	77498655304	3,30	77498655309	3,80

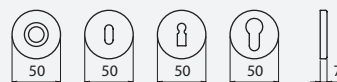

	F1	F2	F3	F4	€	F9	€
COPPIA ROS 50x7 F.18	77448531401	77448531402	77448531403	77448531404	2,40	77448531409	2,70
COPPIA BOC 50x7 PAT	77448631301	77448631302	77448631303	77448631304	2,40	77448631309	2,70
COPPIA BOC 50x7 BB	77448631701	77448631702	77448631703	77448631704	2,40	77448631709	2,70
COPPIA BOC 50x7 YALE	77448635401	77448635402	77448635403	77448635404	2,40	77448635409	2,70
COPPIA ROS 50x7 F.18 C/BUSS	77448531201	77448531202	77448531203	77448531204	2,40	77448531209	2,70
COPPIA BOC 50x7 PAT C/BUSS	77448631401	77448631402	77448631403	77448631404	2,40	77448631409	2,70
COPPIA BOC 50x7 BB C/BUSS	77448631601	77448631602	77448631603	77448631604	2,40	77448631609	2,70
COPPIA BOC 50x7 YALE C/BUSS	77448635301	77448635302	77448635303	77448635304	2,40	77448635309	2,70
COPPIA ROS 52x10 F.18	77398531301	77398531302	77398531303	77398531304	2,50	77398531309	2,95
COPPIA BOC 52x10 PAT	77398631301	77398631302	77398631303	77398631304	2,50	77398631309	2,95
COPPIA BOC 52x10 BB	77398631701	77398631702	77398631703	77398631704	2,50	77398631709	2,95
COPPIA BOC 52x10 YALE	77398635301	77398635302	77398635303	77398635304	2,50	77398635309	2,95

ROSETTE E BOCCHETTE

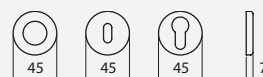

	F1	F2	F3	F4	€	F9	€
COPPIA ROS 45x7 F.18	77448531001	77448531002	77448531003	77448531004	2,20	77448531009	2,50
COPPIA BOC 45x7 PAT	77448631001	77448631002	77448631003	77448631004	2,20	77448631009	2,50
COPPIA BOC 45x7 YALE	77448635001	77448635002	77448635003	77448635004	2,20	77448635009	2,50

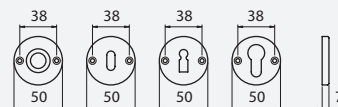

	F1	F2	F3	F4	€	F9	€
COPPIA ROS 50x7 F.20 V.V.	77448543001	77448543002	77448543003	77448543004	2,20	77448543009	2,50
COPPIA BOC 50x7 PAT V.V.	77448643001	77448643002	77448643003	77448643004	2,20	77448643009	2,50
COPPIA BOC 50x7 BB V.V.	77448644001	77448644002	77448644003	77448644004	2,20	77448644009	2,50
COPPIA BOC 50x7 YALE V.V.	77448647001	77448647002	77448647003	77448647004	2,20	77448647009	2,50

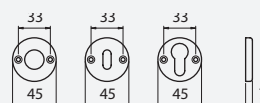

	F1	F2	F3	F4	€	F9	€
COPPIA ROS 45x7 F.20 V.V.	77448541001	77448541002	77448541003	77448541004	2,05	77448541009	2,40
COPPIA BOC 45x7 PAT V.V.	77448641001	77448641002	77448641003	77448641004	2,05	77448641009	2,40
COPPIA BOC 45x7 YALE V.V.	77448645001	77448645002	77448645003	77448645004	2,05	77448645009	2,40

ROSETTE E BOCCHETTE

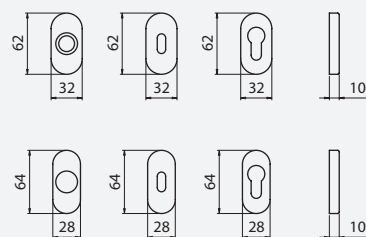

	F1	F2	F3	F4	€	F9	€
COPPIA ROS 30x60 F.18 OVALE	77398521001	77398521002	77398521003	77398521004	2,40	77398521009	2,70
COPPIA BOC 30x60 PAT OVALE	77398621001	77398621002	77398621003	77398621004	2,40	77398621009	2,70
COPPIA BOC 30x60 YALE OVALE	77398625001	77398625002	77398625003	77398625004	2,40	77398625009	2,70
COPPIA ROS 28x64 F.18 OVALE	77398522001	77398522002	77398522003	77398522004	2,40	77398522009	2,70
COPPIA BOC 28x64 PAT OVALE	77398621501	77398621502	77398621503	77398621504	2,40	77398621509	2,70
COPPIA BOC 28x64 YALE OVALE	77398625501	77398625502	77398625503	77398625504	2,40	77398625509	2,70

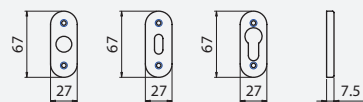

	F1	F2	F3	F4	€	F9	€
COPPIA ROS 28x68 F.20 OV V.V.	77448521001	77448521002	77448521003	77448521004	2,05	77448521009	2,40
COPPIA BOC 28x68 PAT OV V.V.	77448621001	77448621002	77448621003	77448621004	2,05	77448621009	2,40
COPPIA BOC 28x68 YALE OV V.V.	77448625001	77448625002	77448625003	77448625004	2,05	77448625009	2,40

NOTTOLINI WC

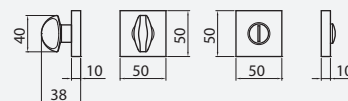

	F1	F2	F3	F4	€	F9	€
NOTT WC Q6 R50x50	77448668001	77448668002	77448668003	77448668004	8,60	77448668009	8,60
NOTT WC Q8 R50x50	77448668501	77448668502	77448668503	77448668504	8,60	77448668509	8,60
NOTT WC Q6 R50x50 C/BUSS	77448668401	77448668402	77448668403	77448668404	8,60	77448668409	8,60
NOTT WC Q8 R50x50 C/BUSS	77448668901	77448668902	77448668903	77448668904	8,60	77448668909	8,60

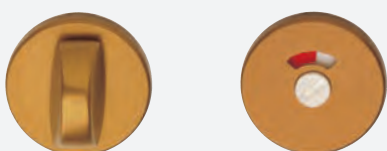

	F1	F2	F3	F4	€	F9	€
NOTT WC Q6 R50x7	77448638001	77448638002	77448638003	77448638004	5,30	77448638009	6,00
NOTT WC Q8 R50x7	77448638501	77448638502	77448638503	77448638504	5,30	77448638509	6,00
NOTT WC Q6 R50x7 C/BUSS	77448638401	77448638402	77448638403	77448638404	6,10	77448638409	7,00
NOTT WC Q8 R50x7 C/BUSS	77448638901	77448638902	77448638903	77448638904	6,10	77448638909	7,00

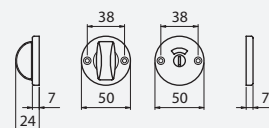

	F1	F2	F3	F4	€	F9	€
NOTT WC Q6 R50x7 V.V.	77448648001	77448648002	77448648003	77448648004	5,10	77448648009	5,90
NOTT WC Q8 R50x7 V.V.	77448648501	77448648502	77448648503	77448648504	5,10	77448648509	5,90

PLACCA B

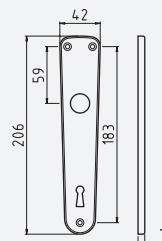

	F1	F2	F3	F4	€	F9	€
COPPIA PLACCHE B CH 90	79010851001	79010851002	79010851003	79010851004	3,20	79010851009	3,70
COPPIA PLACCHE B CH 70	79010857001	79010857002	79010857003	79010857004	3,20	79010857009	3,70
COPPIA PLACCHE B BB 72	79010851601	79010851602	79010851603	79010851604	3,20	79010851609	3,70
COPPIA PLACCHE B BB 90	79010851201	79010851202	79010851203	79010851204	3,20	79010851209	3,70
COPPIA PLACCHE B YALE 72	79010855601	79010855602	79010855603	79010855604	3,20	79010855609	3,70
COPPIA PLACCHE B YALE 85	79010855001	79010855002	79010855003	79010855004	3,20	79010855009	3,70
COPPIA PLACCHE B YALE 90	79010855901	79010855902	79010855903	79010855904	3,20	79010855909	3,70
COPPIA PLACCHE B WC72	79010088601	79010088602	79010088603	79010088604	6,20	79010088609	7,10
COPPIA PLACCHE B WC90	79010088801	79010088802	79010088803	79010088804	6,20	79010088809	7,10

PLACCA B1

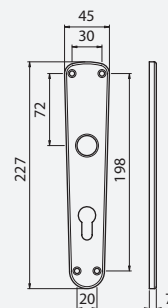

	F1	F2	F3	F4	€	F9	€
COPPIA PLACCHE B1 BB 72	79020851601	79020851602	79020851603	79020851604	3,40	79020851609	3,90
COPPIA PLACCHE B1 YALE 72	79020855601	79020855602	79020855603	79020855604	3,40	79020855609	3,90

PLACCA B2

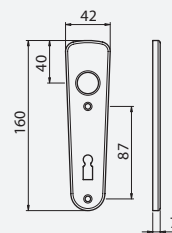

	F1	F2	F3	F4	€	F9	€
COPPIA PLACCHE B2 BB 72	79030851601	79030851602	79030851603	79030851604	2,90	79030851609	3,30
COPPIA PLACCHE B2 YALE 72	79030855601	79030855602	79030855603	79030855604	2,90	79030855609	3,30

PLACCA C

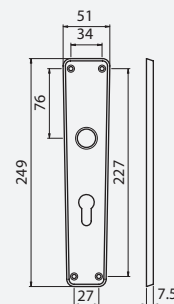

	F1	F2	F3	F4	€	F9	€
COPPIA PLACCHE C YALE 92	79210856101	79210856102	79210856103	79210856104	9,00	79210856109	10,30



PLACCA CH

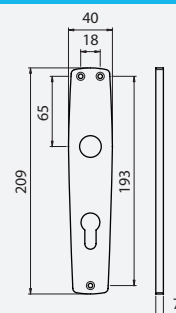

	F1	F2	F3	F4	€	F9	€
COPPIA PLACCHE CH BB 78	79040857201	79040857202	79040857203	79040857204	5,90	79040857209	6,80
COPPIA PLACCHE CH YALE 78	79040855701	79040855702	79040855703	79040855704	5,90	79040855709	6,80



PLACCA E

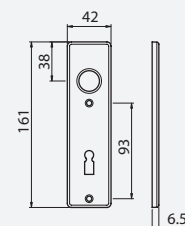

	F1	F2	F3	F4	€	F9	€
COPPIA PLACCHE E BB 72	79050851601	79050851602	79050851603	79050851604	3,20	79050851609	3,70
COPPIA PLACCHE E YALE 72	79050855601	79050855602	79050855603	79050855604	3,20	79050855609	3,70
COPPIA PLACCHE E WC72	79050088601	79050088602	79050088603	79050088604	6,20	79050088609	7,10



PLACCA I

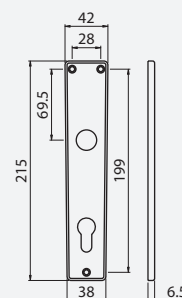

	F1	F2	F3	F4	€	F9	€
COPPIA PLACCHE I CH 90	79060851001	79060851002	79060851003	79060851004	3,20	79060851009	3,70
COPPIA PLACCHE I CH 70	79060857001	79060857002	79060857003	79060857004	3,20	79060857009	3,70
COPPIA PLACCHE I BB 72	79060851601	79060851602	79060851603	79060851604	3,20	79060851609	3,70
COPPIA PLACCHE I BB 90	79060851201	79060851202	79060851203	79060851204	3,20	79060851209	3,70
COPPIA PLACCHE I YALE 72	79060855601	79060855602	79060855603	79060855604	3,20	79060855609	3,70
COPPIA PLACCHE I YALE 85	79060855001	79060855002	79060855003	79060855004	3,20	79060855009	3,70
COPPIA PLACCHE I YALE 90	79060855901	79060855902	79060855903	79060855904	3,20	79060855909	3,70
COPPIA PLACCHE I WC72	79060088601	79060088602	79060088603	79060088604	6,20	79060088609	7,10
COPPIA PLACCHE I WC90	79060088801	79060088802	79060088803	79060088804	6,20	79060088809	7,10



PLACCA P

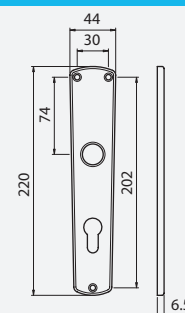

	F1	F2	F3	F4	€	F9	€
COPPIA PLACCHE P BB 72	79110851601	79110851602	79110851603	79110851604	3,30	79110851609	3,80
COPPIA PLACCHE P BB 90	79110851201	79110851202	79110851203	79110851204	3,30	79110851209	3,80
COPPIA PLACCHE P YALE 72	79110855601	79110855602	79110855603	79110855604	3,30	79110855609	3,80
COPPIA PLACCHE P YALE 90	79110855901	79110855902	79110855903	79110855904	3,30	79110855909	3,80
COPPIA PLACCHE P WC72	79110088601	79110088602	79110088603	79110088604	6,30	79110088609	7,30
COPPIA PLACCHE P WC90	79110088801	79110088802	79110088803	79110088804	6,30	79110088809	7,30



PLACCA S2

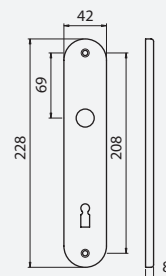

	F1	F2	F3	F4	€	F9	€
COPPIA PLACCHE S 2FV BB 70	79120857201	79120857202	79120857203	79120857204	3,30	79120857209	3,80
COPPIA PLACCHE S 2FV BB 72	79120851601	79120851602	79120851603	79120851604	3,30	79120851609	3,80
COPPIA PLACCHE S 2FV BB 90	79120851201	79120851202	79120851203	79120851204	3,30	79120851209	3,80
COPPIA PLACCHE S 2FV YALE 72	79120855601	79120855602	79120855603	79120855604	3,30	79120855609	3,80
COPPIA PLACCHE S 2FV YALE 85	79120855001	79120855002	79120855003	79120855004	3,30	79120855009	3,80
COPPIA PLACCHE S 2FV YALE 90	79120855901	79120855902	79120855903	79120855904	3,30	79120855909	3,80
COPPIA PLACCHE S 2FV WC72	79120088601	79120088602	79120088603	79120088604	6,30	79120088609	7,30
COPPIA PLACCHE S 2FV WC90	79120088001	79120088002	79120088003	79120088004	6,30	79120088009	7,30

PLACCA S4

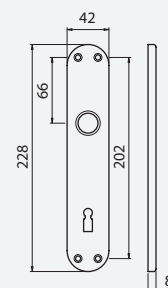

	F1	F2	F3	F4	€	F9	€
COPPIA PLACCHE S 4FV BB 72	79130851601	79130851602	79130851603	79130851604	3,30	79130851609	3,80
COPPIA PLACCHE S 4FV BB 90	79130851201	79130851202	79130851203	79130851204	3,30	79130851209	3,80
COPPIA PLACCHE S 4FV YALE 72	79130855601	79130855602	79130855603	79130855604	3,30	79130855609	3,80
COPPIA PLACCHE S 4FV YALE 90	79130855901	79130855902	79130855903	79130855904	3,30	79130855909	3,80
COPPIA PLACCHE S 4FV WC72	79130088601	79130088602	79130088603	79130088604	6,30	79130088609	7,30
COPPIA PLACCHE S 4FV WC90	79130088001	79130088002	79130088003	79130088004	6,30	79130088009	7,30



PLACCA TB

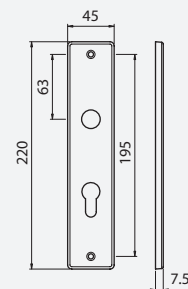

	F1	F2	F3	F4	€	F9	€
COPPIA PLACCHE TB PAT 70	79150857001	79150857002	79150857003	79150857004	4,30	79150857009	4,90
COPPIA PLACCHE TB YALE 70	79150855201	79150855202	79150855203	79150855204	4,30	79150855209	4,90
COPPIA PLACCHE TB WC70	79150088101	79150088102	79150088103	79150088104	7,30	79150088109	8,40



PLACCA TF2

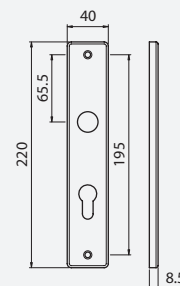

	F1	F2	F3	F4	€	F9	€
COPPIA PLACCHE TF 2FV PAT 70	79160857001	79160857002	79160857003	79160857004	3,80	79160857009	4,50
COPPIA PLACCHE TF 2FV BB 72	79160851601	79160851602	79160851603	79160851604	3,80	79160851609	4,50
COPPIA PLACCHE TF 2FV BB 90	79160851201	79160851202	79160851203	79160851204	3,80	79160851209	4,50
COPPIA PLACCHE TF 2FV YALE 70	79160855201	79160855202	79160855203	79160855204	3,80	79160855209	4,50
COPPIA PLACCHE TF 2FV YALE 72	79160855601	79160855602	79160855603	79160855604	3,80	79160855609	4,50
COPPIA PLACCHE TF 2FV YALE 90	79160855901	79160855902	79160855903	79160855904	3,80	79160855909	4,50
COPPIA PLACCHE TF 2FV WC70	79160088101	79160088102	79160088103	79160088104	6,90	79160088109	8,00
COPPIA PLACCHE TF 2FV WC72	79160088601	79160088602	79160088603	79160088604	6,90	79160088609	8,00
COPPIA PLACCHE TF 2FV WC90	79160088001	79160088002	79160088003	79160088004	6,90	79160088009	8,00

PLACCA TF4

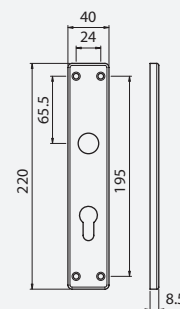

	F1	F2	F3	F4	€	F9	€
COPPIA PLACCHE TF 4FV PAT 70	79170857001	79170857002	79170857003	79170857004	3,80	79170857009	4,50
COPPIA PLACCHE TF 4FV BB 72	79170851601	79170851602	79170851603	79170851604	3,80	79170851609	4,50
COPPIA PLACCHE TF 4FV BB 90	79170851201	79170851202	79170851203	79170851204	3,80	79170851209	4,50
COPPIA PLACCHE TF 4FV YALE 70	79170855201	79170855202	79170855203	79170855204	3,80	79170855209	4,50
COPPIA PLACCHE TF 4FV YALE 72	79170855601	79170855602	79170855603	79170855604	3,80	79170855609	4,50
COPPIA PLACCHE TF 4FV YALE 90	79170855901	79170855902	79170855903	79170855904	3,80	79170855909	4,50
COPPIA PLACCHE TF 4FV WC70	79170088101	79170088102	79170088103	79170088104	6,90	79170088109	8,00
COPPIA PLACCHE TF 4FV WC72	79170088601	79170088602	79170088603	79170088604	6,90	79170088609	8,00
COPPIA PLACCHE TF 4FV WC90	79170088001	79170088002	79170088003	79170088004	6,90	79170088009	8,00

PLACCA V

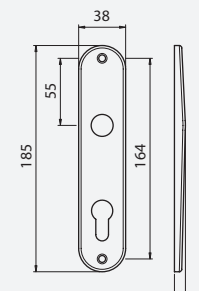

	F1	F2	F3	F4	€	F9	€
COPPIA PLACCHE V PAT 70	79230857001	79230857002	79230857003	79230857004	3,30	79230857009	3,80
COPPIA PLACCHE V YALE 70	79230855201	79230855202	79230855203	79230855204	3,30	79230855209	3,80
COPPIA PLACCHE V WC70	79230088101	79230088102	79230088103	79230088104	6,30	79230088109	7,30



PLACCA X

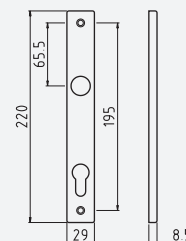

	F1	F2	F3	F4	€	F9	€
COPPIA PLACCHE X CH 90	79180851001	79180851002	79180851003	79180851004	3,60	79180851009	4,20
COPPIA PLACCHE X CH 70	79180857001	79180857002	79180857003	79180857004	3,60	79180857009	4,20
COPPIA PLACCHE X BB 72	79180851601	79180851602	79180851603	79180851604	3,60	79180851609	4,20
COPPIA PLACCHE X BB 90	79180851201	79180851202	79180851203	79180851204	3,60	79180851209	4,20
COPPIA PLACCHE X YALE 72	79180855601	79180855602	79180855603	79180855604	3,60	79180855609	4,20
COPPIA PLACCHE X YALE 85	79180855001	79180855002	79180855003	79180855004	3,60	79180855009	4,20
COPPIA PLACCHE X YALE 90	79180855901	79180855902	79180855903	79180855904	3,60	79180855909	4,20

PLACCA LOCK

DISPONIBILE A RICHIESTA PER APPLICAZIONI SPECIALI

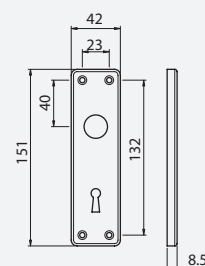

PLACCA LATCH

DISPONIBILE A RICHIESTA PER APPLICAZIONI SPECIALI

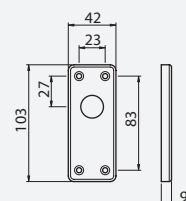

PLACCA FO24

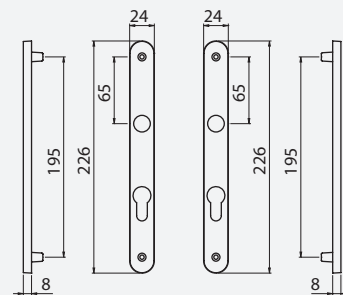

PLACCA FO32

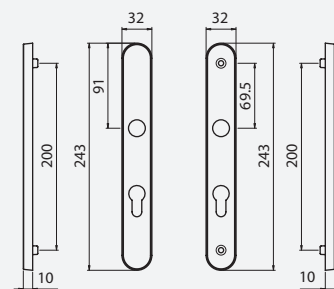

PLACCA FO40

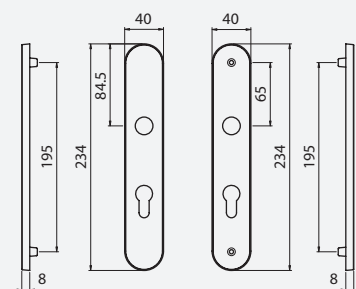

PLACCA FR24

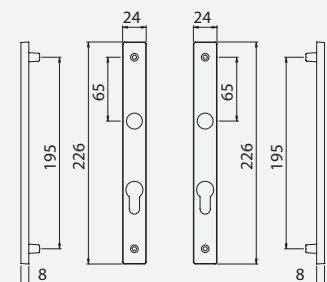

PLACCA FR40

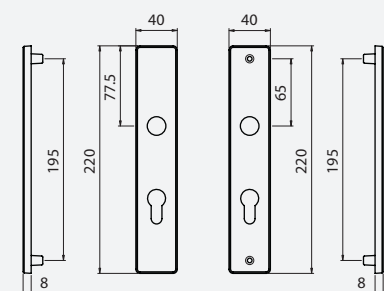

CREMONESE/MARTELLINA UNIVERSALE

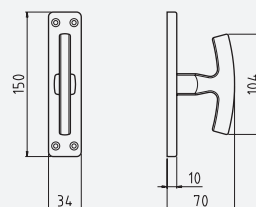

	F1	F2	F3	F4	€	Conf. pz.
CREM/MART SG	77442400001	77442400002	77442400003	77442400004	6,10	16
MART	77442500001	77442500002	77442500003	77442500004	6,30	16



GIOCO EZ 13340605070 € **2,20** Conf. pz. **10**

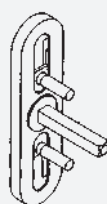

GIOCO GRAZ PERNI Q7 13340905070 € **2,40** Conf. pz. **10**

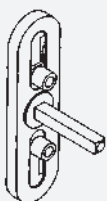

GIOCO EZQ7 13340705070 € **2,50** Conf. pz. **10**



GIOCO MP 13340415070 € **1,75** Conf. pz. **10**



GIOCO GRAZ 13340305070 € **1,70** Conf. pz. **10**

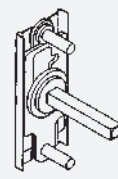

GIOCO MPQ7 13340515070 € **2,20** Conf. pz. **10**



GIOCO GRAZ PERNI 13340205070 € **2,05** Conf. pz. **10**

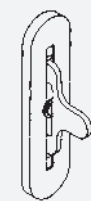

GIOCO GOLA LUPO CENTRALE 13340805011 € **3,90** Conf. pz. **10**

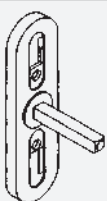

GIOCO GRAZ Q7 13340315070 € **2,00** Conf. pz. **10**

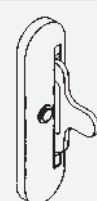

GIOCO GOLA LUPO LATERALE 13340855011 € **3,60** Conf. pz. **10**

3013



	F1	F2	F3	F4	€	Conf. pz.	F9	€	Conf. pz.
MART Q7 ROV	73013521001	73013521002	73013521003	73013521004	3,80	100	73013521009	4,50	100

2010

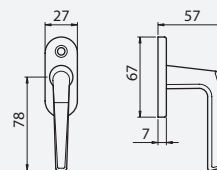

	F1	F2	F3	F4	€	Conf. pz.	F9	€	Conf. pz.
MART Q7 IM ROV	72010521001	72010521002	72010521003	72010521004	3,80	100	72010521009	4,50	100

2013

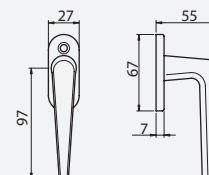

	F1	F2	F3	F4	€	Conf. pz.	F9	€	Conf. pz.
MART Q7 IM ROV	72013521001	72013521002	72013521003	72013521004	3,80	100	72013521009	4,50	100

SEVEN

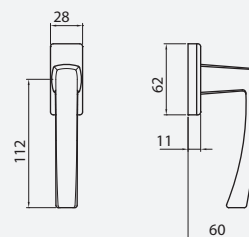

DISPONIBILE ANCHE CON 8
 SCATTI PER MICROVENTILAZIONE

	F1	F2	F3	F4	€	Conf. pz.	F9	€	Conf. pz.
DK x 33	77470555001	77470555002	77470555003	77470555004	4,90	20	77470555009	5,65	20
	7747055500150	7747055500250	7747055500350	7747055500450	4,70	100	7747055500950	5,45	100
DK x 33 C/BUSS. D.9,5	77470556001	77470556002	77470556003	77470556004	4,90	20	77470556009	5,65	20
	7747055600150	7747055600250	7747055600350	7747055600450	4,70	100	7747055600950	5,45	100

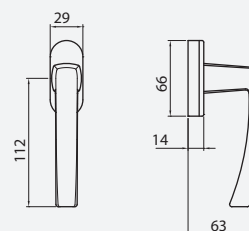

DISPONIBILE ANCHE CON 8
 SCATTI PER MICROVENTILAZIONE

	F1	F2	F3	F4	€	Conf. pz.	F9	€	Conf. pz.
DK x 33	77470557301	77470557302	77470557303	77470557304	4,90	20	77470557309	5,65	20
	7747055730150	7747055730250	7747055730350	7747055730450	4,70	100	7747055730950	5,45	100
DK x 33 C/BUSS. D.9,5	77470558301	77470558302	77470558303	77470558304	4,90	20	77470558309	5,65	20
	7747055830150	7747055830250	7747055830350	7747055830450	4,70	100	7747055830950	5,45	100

BRIXIA

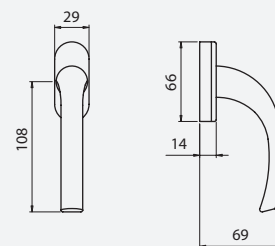

DISPONIBILE ANCHE CON 8
 SCATTI PER MICROVENTILAZIONE

	F1	F2	F3	F4	€	Conf. pz.	F9	€	Conf. pz.
DK x 33	77438557301	77438557302	77438557303	77438557304	5,50	20	77438557309	6,30	20
	7743855730150	7743855730250	7743855730350	7743855730450	5,40	100	7743855730950	6,20	100
DK x 33 C/BUSS. D.9,5	77438558301	77438558302	77438558303	77438558304	5,50	20	77438558309	6,30	20
	7743855830150	7743855830250	7743855830350	7743855830450	5,40	100	7743855830950	6,20	100

PELOPE - 1000

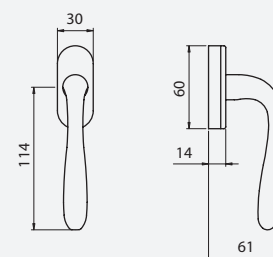

	F1	F2	F3	F4	€	Conf. pz.	F9	€	Conf. pz.
DK x 35	71000557501	71000557502	71000557503	71000557504	6,00	20	71000557509	6,90	20
	7100055750150	7100055750250	7100055750350	7100055750450	5,90	100	7100055750950	6,80	100
DK x 35 C/BUSS. D.9,5	71000558501	71000558502	71000558503	71000558504	6,00	20	71000558509	6,90	20
	7100055850150	7100055850250	7100055850350	7100055850450	5,90	100	7100055850950	6,80	100

ITACA - 2005

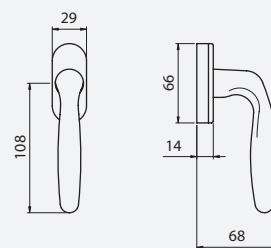

DISPONIBILE ANCHE CON 8
 SCATTI PER MICROVENTILAZIONE

	F1	F2	F3	F4	€	Conf. pz.	F9	€	Conf. pz.
DK x 33	72005557301	72005557302	72005557303	72005557304	5,75	20	72005557309	6,65	20
	7200555730150	7200555730250	7200555730350	7200555730450	5,70	100	7200555730950	6,60	100
DK x 33 C/BUSS. D.9,5	72005558301	72005558302	72005558303	72005558304	5,75	20	72005558309	6,65	20
	7200555830150	7200555830250	7200555830350	7200555830450	5,70	100	7200555830950	6,60	100

GABRY

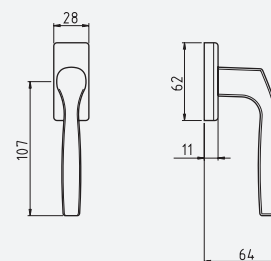

DISPONIBILE ANCHE CON 8
 SCATTI PER MICROVENTILAZIONE

	F1	F2	F3	F4	€	Conf. pz.
DK x 33	77400555001	77400555002	77400555003	77400555004	5,50	20
DK x 33 C/BUSS. D.9,5	77400556001	77400556002	77400556003	77400556004	5,50	20
DK x 33 PERSONALIZZATO	7740055500170	7740055500270	7740055500370	7740055500470	5,80	20
DK x 33 C/BUSS. D.9,5 PERSONALIZZATO	7740055600170	7740055600270	7740055600370	7740055600470	5,80	20

VIENNA

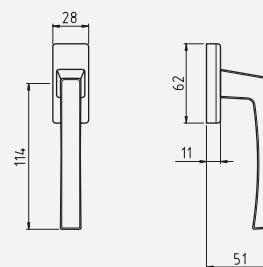

DISPONIBILE ANCHE CON 8
 SCATTI PER MICROVENTILAZIONE

	F1	F2	F3	F4	€	Conf. pz.
DK x 33	77416555001	77416555002	77416555003	77416555004	5,50	20
DK x 33 C/BUSS. D.9,5	77416556001	77416556002	77416556003	77416556004	5,50	20
DK x 33 PERSONALIZZATO	7741655500170	7741655500270	7741655500370	7741655500470	5,80	20
DK x 33 C/BUSS. D.9,5 PERSONALIZZATO	7741655600170	7741655600270	7741655600370	7741655600470	5,80	20

UNIVERSAL

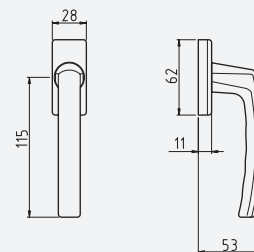

DISPONIBILE ANCHE CON 8
 SCATTI PER MICROVENTILAZIONE

	F1	F2	F3	F4	€	Conf. pz.	F9	€	Conf. pz.
DK x 33	77486555001	77486555002	77486555003	77486555004	5,50	20	77486555009	6,40	20
DK x 33 C/BUSS. D.9,5	77486556001	77486556002	77486556003	77486556004	5,50	20	77486556009	6,40	20
DK x 33 PERSONALIZZATO	7748655500170	7748655500270	7748655500370	7748655500470	5,80	20	7748655500970	6,80	20
DK x 33 C/BUSS. D.9,5 PERSONALIZZATO	7748655600170	7748655600270	7748655600370	7748655600470	5,80	20	7748655600970	6,80	20

4038

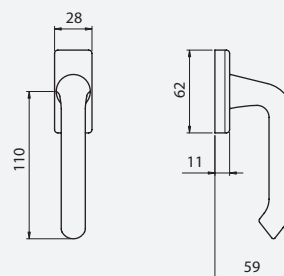

DISPONIBILE ANCHE CON 8
 SCATTI PER MICROVENTILAZIONE

	F1	F2	F3	F4	€	Conf. pz.
DK x 33	74038555301	74038555302	74038555303	74038555304	4,90	20
	7403855530150	7403855530250	7403855530350	7403855530450	4,70	100
DK x 33 C/BUSS. D.9,5	74038556301	74038556302	74038556303	74038556304	4,90	20
	7403855630150	7403855630250	7403855630350	7403855630450	4,70	100

4008

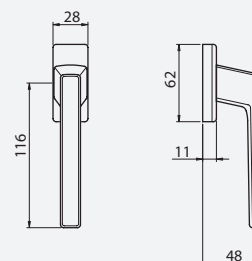

DISPONIBILE ANCHE CON 8
 SCATTI PER MICROVENTILAZIONE

	F1	F2	F3	F4	€	Conf. pz.
DK x 33	74008555301	74008555302	74008555303	74008555304	5,00	20
	7400855530150	7400855530250	7400855530350	7400855530450	4,80	100
DK x 33 C/BUSS. D.9,5	74008556301	74008556302	74008556303	74008556304	5,00	20
	7400855630150	7400855630250	7400855630350	7400855630450	4,80	100

KEY

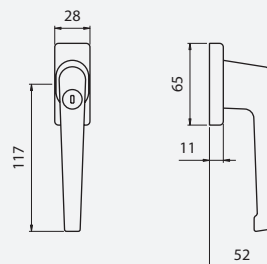

	F1	F2	F3	F4	€	Conf. pz.	GCTOL	€	Conf. pz.
DK x 33	77062555001	77062555002	77062555003	77062555004	12,80	10	77062555012	14,90	10
DK x 33 C/BUSS. D.9,5	77062556001	77062556002	77062556003	77062556004	12,80	10	77062556012	14,90	10

ROOF

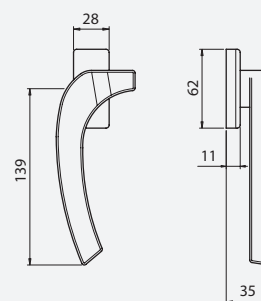

	ACH*	GBR*	€	Conf. pz.
DK S/FERRO	77040554521	77040554552	5,70	20
	7704055452150	7704055455250	5,50	100

ACH* = verniciatura a polvere Champagne metallizzato

GBR* = verniciatura a polvere Bronzo metallizzato

JOLLY - 210 / 7071

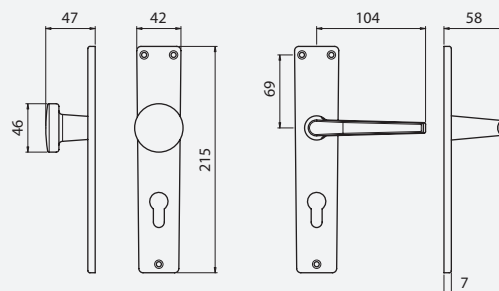

	F1	F2	F3	F4	€	Conf. pz.	F9	€	Conf. pz.
IM + PF PY72	70210984701	70210984702	70210984703	70210984704	14,20	50	70210984709	16,30	50
IM + PF PY85	70210984501	70210984502	70210984503	70210984504	14,20	50	70210984509	16,30	50
IM + PF PY90	70210984101	70210984102	70210984103	70210984104	14,20	50	70210984109	16,30	50

7071

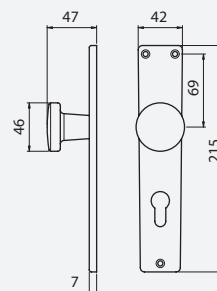

	F1	F2	F3	F4	€	Conf. pz.	F9	€	Conf. pz.
PF PY72 S/FERRO	77071187701	77071187702	77071187703	77071187704	7,30	50	77071187709	8,40	50
PF PY85 S/FERRO	77071188501	77071188502	77071188503	77071188504	7,30	50	77071188509	8,40	50
PF PY90 S/FERRO	77071189101	77071189102	77071189103	77071189104	7,30	50	77071189109	8,40	50

CUORE-7000

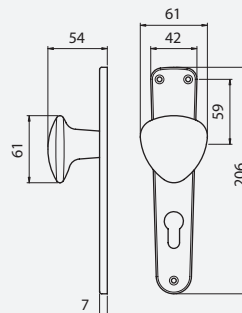

	F1	F2	F3	F4	€	Conf. pz.
PF PY72 S/FERRO	77000187901	77000187902	77000187903	77000187904	7,60	50
PF PY85 S/FERRO	77000188901	77000188902	77000188903	77000188904	7,60	50
PF PY90 S/FERRO	77000189301	77000189302	77000189303	77000189304	7,60	50

JOLLY - 210 / 6006

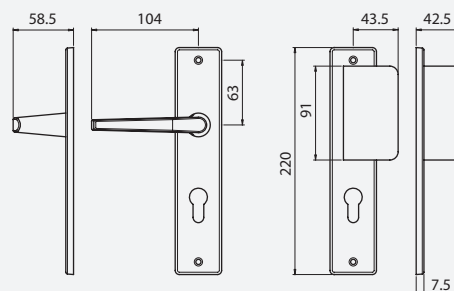

	F1	F2	F3	F4	€	Conf. pz.	F9	€	Conf. pz.
IM Q7 + PALL PY70	70210974501	70210974502	70210974503	70210974504	10,70	25	70210974509	12,30	25
IM Q8 + PALL PY72	70210985701	70210985702	70210985703	70210985704	10,70	25	70210985709	12,30	25
IM Q8 + PALL PY90	70210985801	70210985802	70210985803	70210985804	10,70	25	70210985809	12,30	25

JOLLY - 210 / 6007

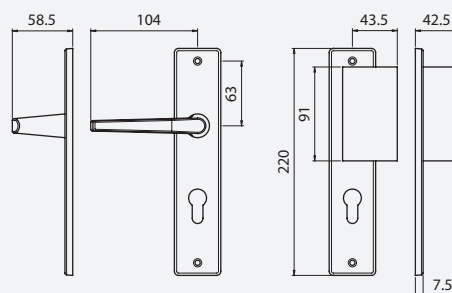

	F1	F2	F3	F4	€	Conf. pz.	F9	€	Conf. pz.
IM Q7 + PALL PY70	70210974601	70210974602	70210974603	70210974604	10,70	25	70210974609	12,30	25
IM Q8 + PALL PY72	70210984801	70210984802	70210984803	70210984804	10,70	25	70210984809	12,30	25
IM Q8 + PALL PY90	70210985901	70210985902	70210985903	70210985904	10,70	25	70210985909	12,30	25

7071

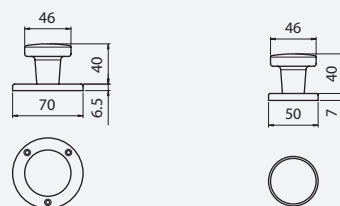

	F1	F2	F3	F4	€	Conf. pz.	F9	€	Conf. pz.
POM FISSO R50	77071740001	77071740002	77071740003	77071740004	6,60	50	77071740009	7,60	50
POM FISSO R70 VV	7707174000119	7707174000219	7707174000319	7707174000419	6,90	50	7707174000919	8,00	50

7009

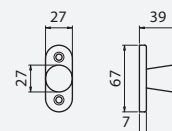

	F1	F2	F3	F4	€	Conf. pz.	F9	€	Conf. pz.
POM FISSO ROVV	77009735301	77009735302	77009735303	77009735304	3,30	50	77009735309	3,80	50

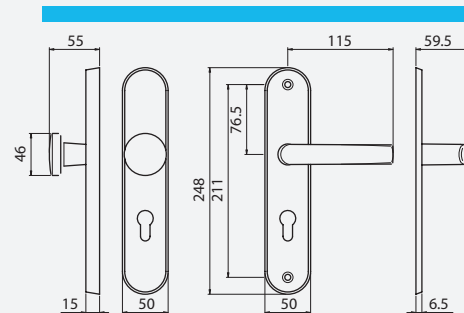

	F1	F2	F3	F4	€	Conf. pz.	F9	€	Conf. pz.
IM + POM SIC YALE 72	7014398970169	7014398970269	7014398970369	7014398970469	38,30	1	7014398970969	44,00	1
IM + POM SIC YALE 88	7014398840169	7014398840269	7014398840369	7014398840469	38,30	1	7014398840969	44,00	1
IM + POM SIC YALE 90	7014398910169	7014398910269	7014398910369	7014398910469	38,30	1	7014398910969	44,00	1

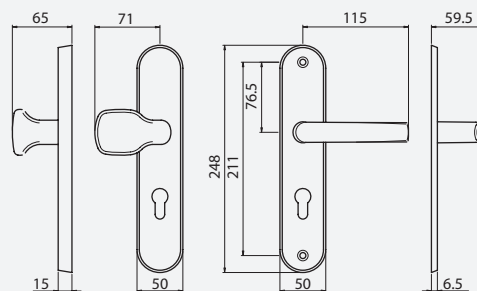

	F1	F2	F3	F4	€	Conf. pz.	F9	€	Conf. pz.
IM + PS SIC YALE 72	7014399120169	7014399120269	7014399120369	7014399120469	38,90	1	7014399120969	44,70	1
IM + PS SIC YALE 88	7014399080169	7014399080269	7014399080369	7014399080469	38,90	1	7014399080969	44,70	1
IM + PS SIC YALE 90	7014399110169	7014399110269	7014399110369	7014399110469	38,90	1	7014399110969	44,70	1

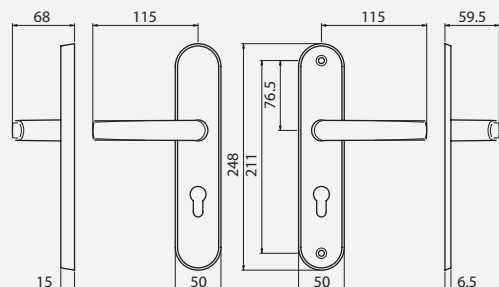

	F1	F2	F3	F4	€	Conf. pz.	F9	€	Conf. pz.
IM + IM SIC YALE 72	7014398980169	7014398980269	7014398980369	7014398980469	37,30	1	7014398980969	42,90	1
IM + IM SIC YALE 88	7014398880169	7014398880269	7014398880369	7014398880469	37,30	1	7014398880969	42,90	1
IM + IM SIC YALE 90	7014398920169	7014398920269	7014398920369	7014398920469	37,30	1	7014398920969	42,90	1

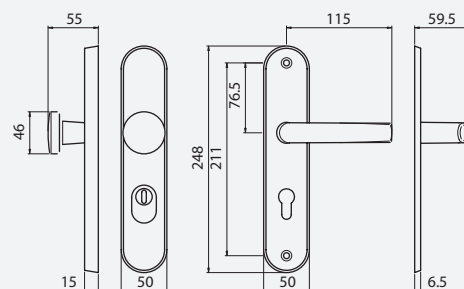

	F1	F2	F3	F4	€	Conf. pz.	F9	€	Conf. pz.
IM + POM SIC KS 72	7014398970168	7014398970268	7014398970368	7014398970468	42,60	1	7014398970968	49,00	1
IM + POM SIC KS 88	7014398840168	7014398840268	7014398840368	7014398840468	42,60	1	7014398840968	49,00	1
IM + POM SIC KS 90	7014398910168	7014398910268	7014398910368	7014398910468	42,60	1	7014398910968	49,00	1

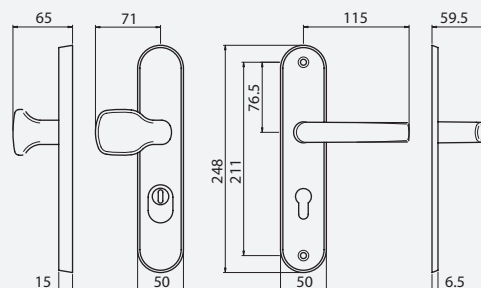

	F1	F2	F3	F4	€	Conf. pz.	F9	€	Conf. pz.
IM + PS SIC KS 72	7014399120168	7014399120268	7014399120368	7014399120468	43,20	1	7014399120968	49,60	1
IM + PS SIC KS 88	7014399080168	7014399080268	7014399080368	7014399080468	43,20	1	7014399080968	49,60	1
IM + PS SIC KS 90	7014399110168	7014399110268	7014399110368	7014399110468	43,20	1	7014399110968	49,60	1

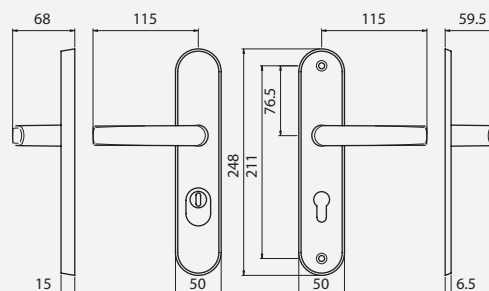

	F1	F2	F3	F4	€	Conf. pz.	F9	€	Conf. pz.
IM + IM SIC KS 72	7014398980168	7014398980268	7014398980368	7014398980468	41,60	1	7014398980968	47,80	1
IM + IM SIC KS 88	7014398880168	7014398880268	7014398880368	7014398880468	41,60	1	7014398880968	47,80	1
IM + IM SIC KS 90	7014398920168	7014398920268	7014398920368	7014398920468	41,60	1	7014398920968	47,80	1



EUROPA - 238

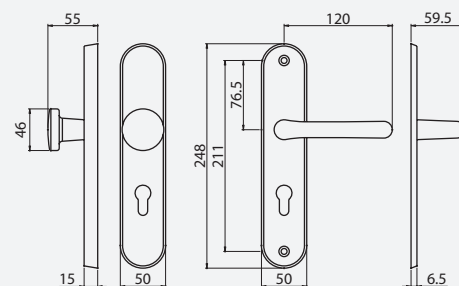

	F1	F2	F3	F4	€	Conf. pz.	F9	€	Conf. pz.
IM + POM SIC YALE 72	7023898970169	7023898970269	7023898970369	7023898970469	38,60	1	7023898970969	44,40	1
IM + POM SIC YALE 88	7023898840169	7023898840269	7023898840369	7023898840469	38,60	1	7023898840969	44,40	1
IM + POM SIC YALE 90	7023898910169	7023898910269	7023898910369	7023898910469	38,60	1	7023898910969	44,40	1

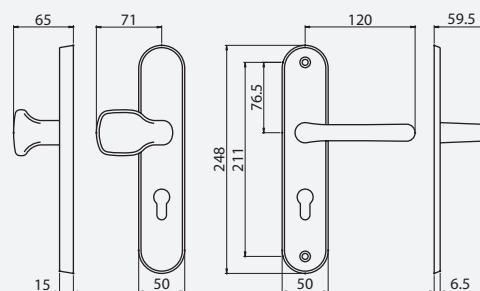

	F1	F2	F3	F4	€	Conf. pz.	F9	€	Conf. pz.
IM + PS SIC YALE 72	7023899120169	7023899120269	7023899120369	7023899120469	39,20	1	7023899120969	45,00	1
IM + PS SIC YALE 88	7023899080169	7023899080269	7023899080369	7023899080469	39,20	1	7023899080969	45,00	1
IM + PS SIC YALE 90	7023899110169	7023899110269	7023899110369	7023899110469	39,20	1	7023899110969	45,00	1

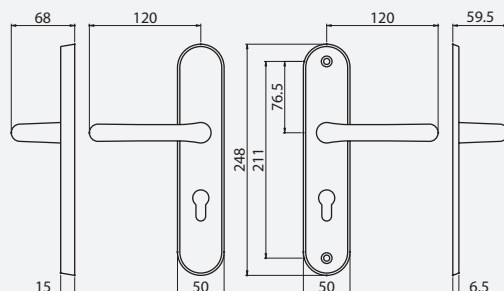

	F1	F2	F3	F4	€	Conf. pz.	F9	€	Conf. pz.
IM + IM SIC YALE 72	7023898980169	7023898980269	7023898980369	7023898980469	37,60	1	7023898980969	43,30	1
IM + IM SIC YALE 88	7023898880169	7023898880269	7023898880369	7023898880469	37,60	1	7023898880969	43,30	1
IM + IM SIC YALE 90	7023898920169	7023898920269	7023898920369	7023898920469	37,60	1	7023898920969	43,30	1

EUROPA - 238

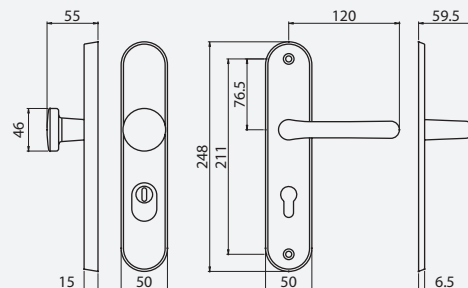

	F1	F2	F3	F4	€	Conf. pz.	F9	€	Conf. pz.
IM + POM SIC KS 72	7023898970168	7023898970268	7023898970368	7023898970468	42,90	1	7023898970968	49,40	1
IM + POM SIC KS 88	7023898840168	7023898840268	7023898840368	7023898840468	42,90	1	7023898840968	49,40	1
IM + POM SIC KS 90	7023898910168	7023898910268	7023898910368	7023898910468	42,90	1	7023898910968	49,40	1

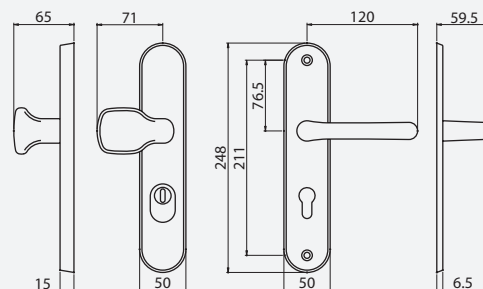
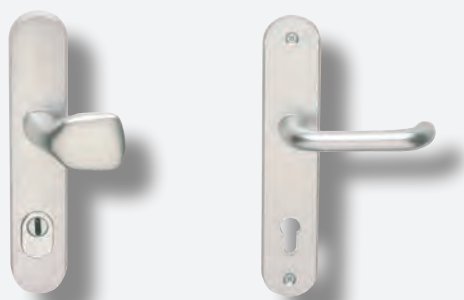

	F1	F2	F3	F4	€	Conf. pz.	F9	€	Conf. pz.
IM + PS SIC KS 72	7023899120168	7023899120268	7023899120368	7023899120468	43,50	1	7023899120968	50,00	1
IM + PS SIC KS 88	7023899080168	7023899080268	7023899080368	7023899080468	43,50	1	7023899080968	50,00	1
IM + PS SIC KS 90	7023899110168	7023899110268	7023899110368	7023899110468	43,50	1	7023899110968	50,00	1

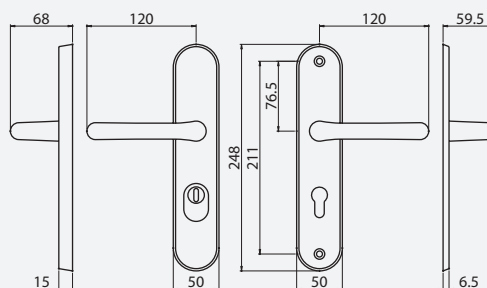
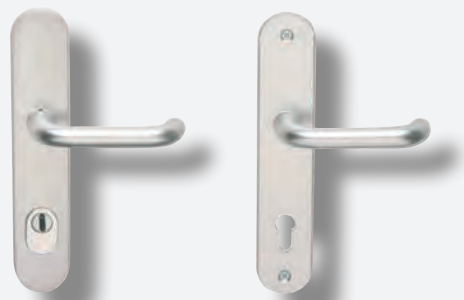

	F1	F2	F3	F4	€	Conf. pz.	F9	€	Conf. pz.
IM + IM SIC KS 72	7023898980168	7023898980268	7023898980368	7023898980468	41,90	1	7023898980968	48,20	1
IM + IM SIC KS 88	7023898880168	7023898880268	7023898880368	7023898880468	41,90	1	7023898880968	48,20	1
IM + IM SIC KS 90	7023898920168	7023898920268	7023898920368	7023898920468	41,90	1	7023898920968	48,20	1

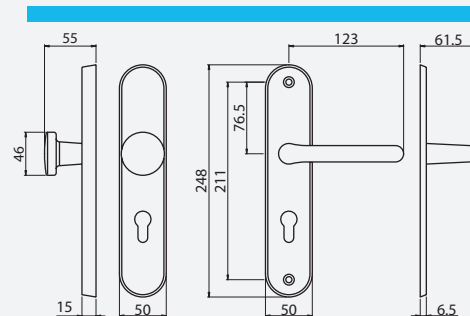

	F1	F2	F3	F4	€	Conf. pz.	F9	€	Conf. pz.
IM + POM SIC YALE 72	7023998970169	7023998970269	7023998970369	7023998970469	39,80	1	7023998970969	45,90	1
IM + POM SIC YALE 88	7023998840169	7023998840269	7023998840369	7023998840469	39,80	1	7023998840969	45,90	1
IM + POM SIC YALE 90	7023998910169	7023998910269	7023998910369	7023998910469	39,80	1	7023998910969	45,90	1

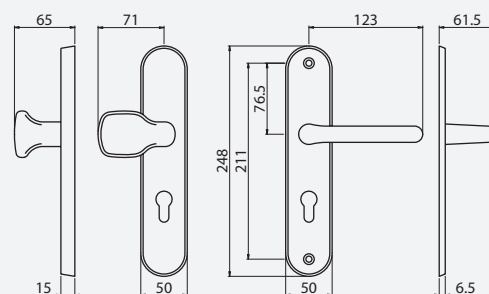
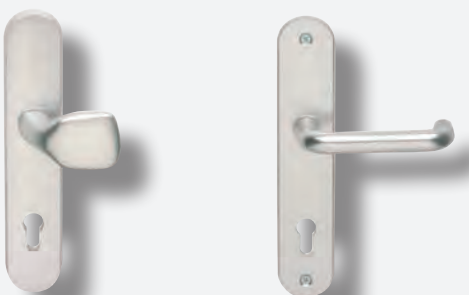

	F1	F2	F3	F4	€	Conf. pz.	F9	€	Conf. pz.
IM + PS SIC YALE 72	7023999120169	7023999120269	7023999120369	7023999120469	40,40	1	7023999120969	46,50	1
IM + PS SIC YALE 88	7023999080169	7023999080269	7023999080369	7023999080469	40,40	1	7023999080969	46,50	1
IM + PS SIC YALE 90	7023999110169	7023999110269	7023999110369	7023999110469	40,40	1	7023999110969	46,50	1

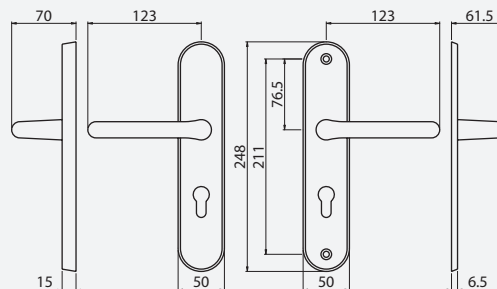
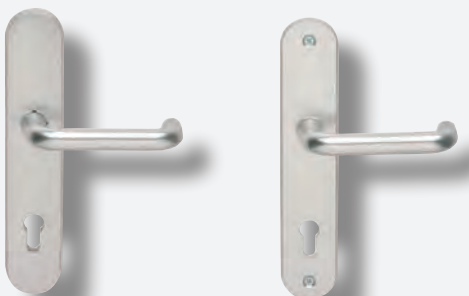

	F1	F2	F3	F4	€	Conf. pz.	F9	€	Conf. pz.
IM + IM SIC YALE 72	7023998980169	7023998980269	7023998980369	7023998980469	38,90	1	7023998980969	44,70	1
IM + IM SIC YALE 88	7023998880169	7023998880269	7023998880369	7023998880469	38,90	1	7023998880969	44,70	1
IM + IM SIC YALE 90	7023998920169	7023998920269	7023998920369	7023998920469	38,90	1	7023998920969	44,70	1

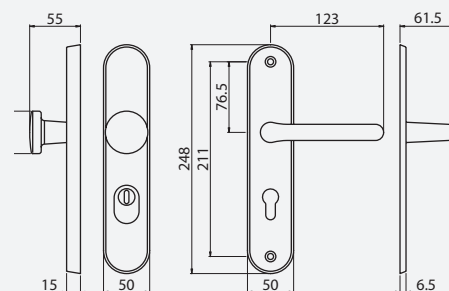

	F1	F2	F3	F4	€	Conf. pz.	F9	€	Conf. pz.
IM + POM SIC KS 72	7023998970168	7023998970268	7023998970368	7023998970468	44,20	1	7023998970968	50,80	1
IM + POM SIC KS 88	7023998840168	7023998840268	7023998840368	7023998840468	44,20	1	7023998840968	50,80	1
IM + POM SIC KS 90	7023998910168	7023998910268	7023998910368	7023998910468	44,20	1	7023998910968	50,80	1

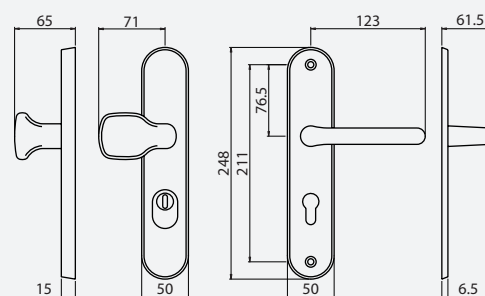

	F1	F2	F3	F4	€	Conf. pz.	F9	€	Conf. pz.
IM + PS SIC KS 72	7023999120168	7023999120268	7023999120368	7023999120468	44,70	1	7023999120968	51,50	1
IM + PS SIC KS 88	7023999080168	7023999080268	7023999080368	7023999080468	44,70	1	7023999080968	51,50	1
IM + PS SIC KS 90	7023999110168	7023999110268	7023999110368	7023999110468	44,70	1	7023999110968	51,50	1

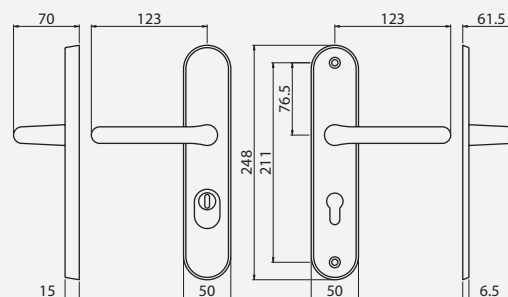

	F1	F2	F3	F4	€	Conf. pz.	F9	€	Conf. pz.
IM + IM SIC KS 72	7023998980168	7023998980268	7023998980368	7023998980468	43,20	1	7023998980968	49,60	1
IM + IM SIC KS 88	7023998880168	7023998880268	7023998880368	7023998880468	43,20	1	7023998880968	49,60	1
IM + IM SIC KS 90	7023998920168	7023998920268	7023998920368	7023998920468	43,20	1	7023998920968	49,60	1

2004

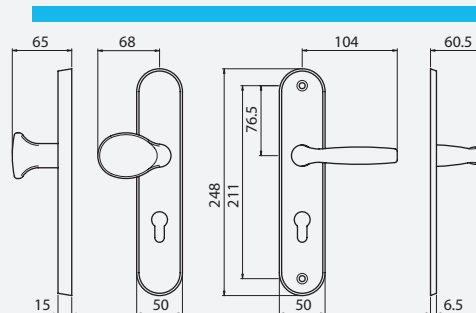

	F1	F2	F3	F4	€	Conf. pz.	F9	€	Conf. pz.
IM + PS SIC YALE 72	7200499120169	7200499120269	7200499120369	7200499120469	39,20	1	7200499120969	45,00	1
IM + PS SIC YALE 88	7200499080169	7200499080269	7200499080369	7200499080469	39,20	1	7200499080969	45,00	1
IM + PS SIC YALE 90	7200499110169	7200499110269	7200499110369	7200499110469	39,20	1	7200499110969	45,00	1

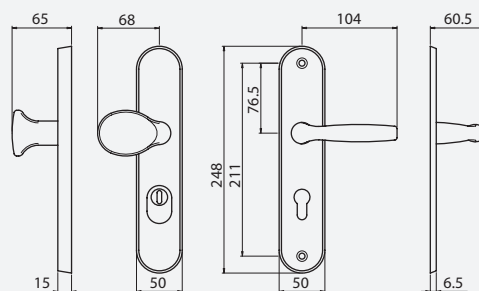

	F1	F2	F3	F4	€	Conf. pz.	F9	€	Conf. pz.
IM + PS SIC KS 72	7200499120168	7200499120268	7200499120368	7200499120468	43,50	1	7200499120968	50,00	1
IM + PS SIC KS 88	7200499080168	7200499080268	7200499080368	7200499080468	43,50	1	7200499080968	50,00	1
IM + PS SIC KS 90	7200499110168	7200499110268	7200499110368	7200499110468	43,50	1	7200499110968	50,00	1

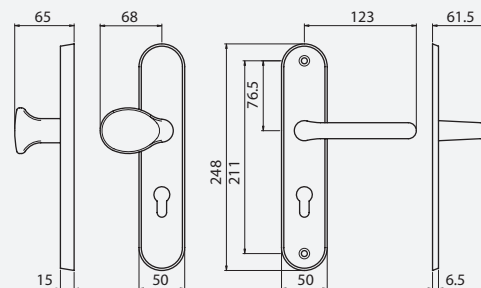

	F1	F2	F3	F4	€	Conf. pz.	F9	€	Conf. pz.
IM + PS SIC YALE 72	7023999120179	7023999120279	7023999120379	7023999120479	40,40	1	7023999120979	46,50	1
IM + PS SIC YALE 88	7023999080179	7023999080279	7023999080379	7023999080479	40,40	1	7023999080979	46,50	1
IM + PS SIC YALE 90	7023999110179	7023999110279	7023999110379	7023999110479	40,40	1	7023999110979	46,50	1

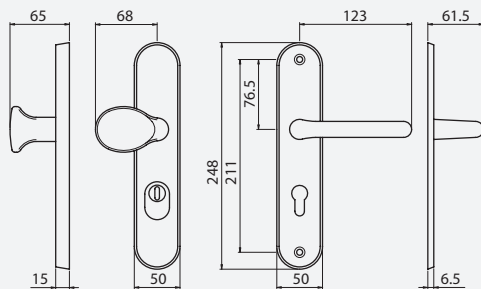

	F1	F2	F3	F4	€	Conf. pz.	F9	€	Conf. pz.
IM + PS SIC KS 72	7023999120178	7023999120278	7023999120378	7023999120478	44,70	1	7023999120978	51,50	1
IM + PS SIC KS 88	7023999080178	7023999080278	7023999080378	7023999080478	44,70	1	7023999080978	51,50	1
IM + PS SIC KS 90	7023999110178	7023999110278	7023999110378	7023999110478	44,70	1	7023999110978	51,50	1

KIT SENZA MANIGLIA

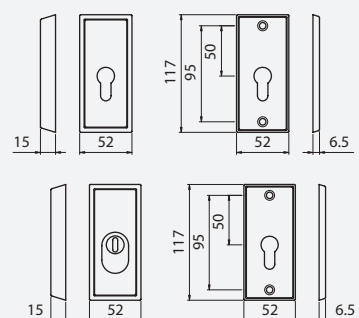

	F1	F2	F3	F4	€	Conf. pz.	F9	€	Conf. pz.
KIT SICUR RETT mm 117x52 YALE	77448685101	77448685102	77448685103	77448685104	27,00	1	77448685109	31,10	1
KIT SICUR RETT mm 117x52 KS	77448685501	77448685502	77448685503	77448685504	31,30	1	77448685509	36,00	1



JOLLY - 210

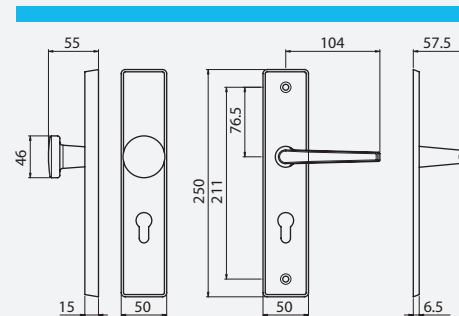

	F1	F2	F3	F4	€	Conf. pz.	F9	€	Conf. pz.
IM + POM SIC YALE 72	7021098970169	7021098970269	7021098970369	7021098970469	38,00	1	7021098970969	43,70	1
IM + POM SIC YALE 88	7021098840169	7021098840269	7021098840369	7021098840469	38,00	1	7021098840969	43,70	1
IM + POM SIC YALE 90	7021098910169	7021098910269	7021098910369	7021098910469	38,00	1	7021098910969	43,70	1

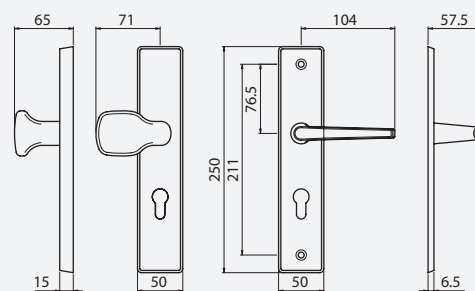

	F1	F2	F3	F4	€	Conf. pz.	F9	€	Conf. pz.
IM + PS SIC YALE 72	7021099120169	7021099120269	7021099120369	7021099120469	38,60	1	7021099120969	44,40	1
IM + PS SIC YALE 88	7021099080169	7021099080269	7021099080369	7021099080469	38,60	1	7021099080969	44,40	1
IM + PS SIC YALE 90	7021099110169	7021099110269	7021099110369	7021099110469	38,60	1	7021099110969	44,40	1

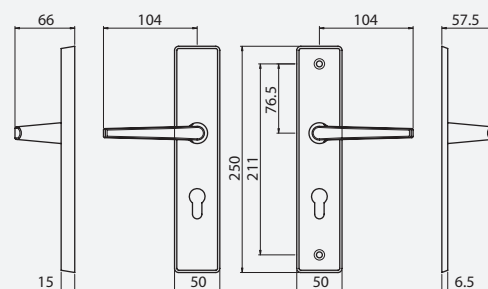

	F1	F2	F3	F4	€	Conf. pz.	F9	€	Conf. pz.
IM + IM SIC YALE 72	7021098980169	7021098980269	7021098980369	7021098980469	37,00	1	7021098980969	42,60	1
IM + IM SIC YALE 88	7021098880169	7021098880269	7021098880369	7021098880469	37,00	1	7021098880969	42,60	1
IM + IM SIC YALE 90	7021098920169	7021098920269	7021098920369	7021098920469	37,00	1	7021098920969	42,60	1



JOLLY - 210

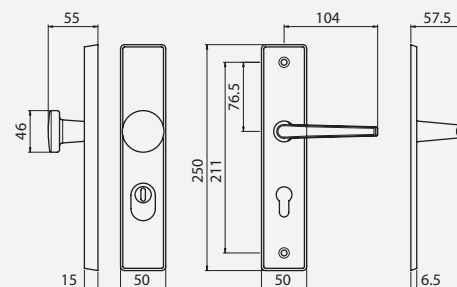

	F1	F2	F3	F4	€	Conf. pz.	F9	€	Conf. pz.
IM + POM SIC KS 72	7021098970168	7021098970268	7021098970368	7021098970468	42,30	1	7021098970968	48,70	1
IM + POM SIC KS 88	7021098840168	7021098840268	7021098840368	7021098840468	42,30	1	7021098840968	48,70	1
IM + POM SIC KS 90	7021098910168	7021098910268	7021098910368	7021098910468	42,30	1	7021098910968	48,70	1

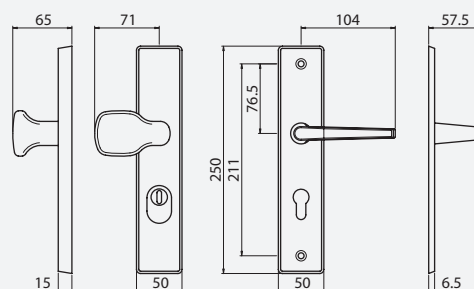

	F1	F2	F3	F4	€	Conf. pz.	F9	€	Conf. pz.
IM + PS SIC KS 72	7021099120168	7021099120268	7021099120368	7021099120468	42,90	1	7021099120968	49,40	1
IM + PS SIC KS 88	7021099080168	7021099080268	7021099080368	7021099080468	42,90	1	7021099080968	49,40	1
IM + PS SIC KS 90	7021099110168	7021099110268	7021099110368	7021099110468	42,90	1	7021099110968	49,40	1

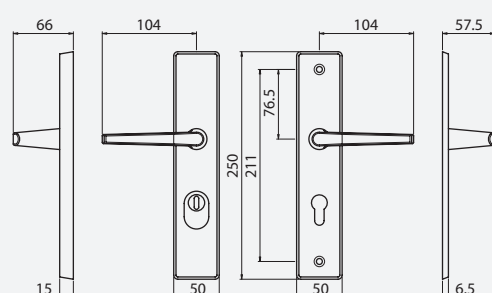

	F1	F2	F3	F4	€	Conf. pz.	F9	€	Conf. pz.
IM + IM SIC KS 72	7021098980168	7021098980268	7021098980368	7021098980468	41,30	1	7021098980968	47,50	1
IM + IM SIC KS 88	7021098880168	7021098880268	7021098880368	7021098880468	41,30	1	7021098880968	47,50	1
IM + IM SIC KS 90	7021098920168	7021098920268	7021098920368	7021098920468	41,30	1	7021098920968	47,50	1



220

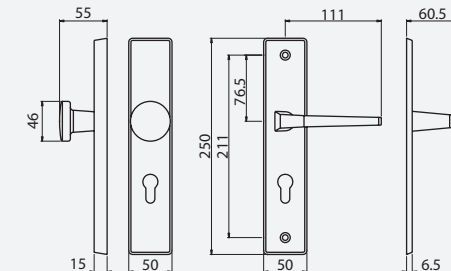

	F1	F2	F3	F4	€	Conf. pz.	F9	€	Conf. pz.
IM + POM SIC YALE 72	7022098970169	7022098970269	7022098970369	7022098970469	38,00	1	7022098970969	43,70	1
IM + POM SIC YALE 88	7022098840169	7022098840269	7022098840369	7022098840469	38,00	1	7022098840969	43,70	1
IM + POM SIC YALE 90	7022098910169	7022098910269	7022098910369	7022098910469	38,00	1	7022098910969	43,70	1

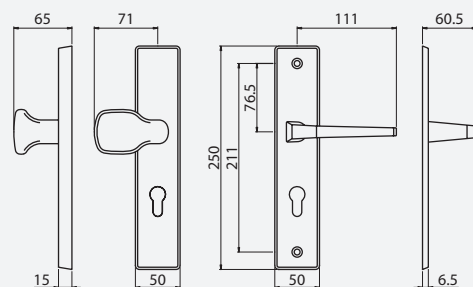

	F1	F2	F3	F4	€	Conf. pz.	F9	€	Conf. pz.
IM + PS SIC YALE 72	7022099120169	7022099120269	7022099120369	7022099120469	38,60	1	7022099120969	44,40	1
IM + PS SIC YALE 88	7022099080169	7022099080269	7022099080369	7022099080469	38,60	1	7022099080969	44,40	1
IM + PS SIC YALE 90	7022099110169	7022099110269	7022099110369	7022099110469	38,60	1	7022099110969	44,40	1

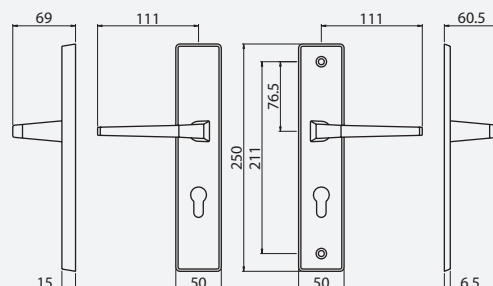

	F1	F2	F3	F4	€	Conf. pz.	F9	€	Conf. pz.
IM + IM SIC YALE 72	7022098980169	7022098980269	7022098980369	7022098980469	37,00	1	7022098980969	42,60	1
IM + IM SIC YALE 88	7022098880169	7022098880269	7022098880369	7022098880469	37,00	1	7022098880969	42,60	1
IM + IM SIC YALE 90	7022098920169	7022098920269	7022098920369	7022098920469	37,00	1	7022098920969	42,60	1

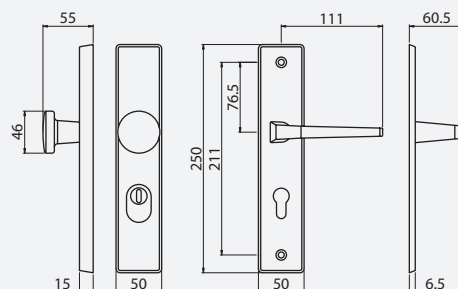

	F1	F2	F3	F4	€	Conf. pz.	F9	€	Conf. pz.
IM + POM SIC KS 72	7022098970168	7022098970268	7022098970368	7022098970468	42,30	1	7022098970968	48,70	1
IM + POM SIC KS 88	7022098840168	7022098840268	7022098840368	7022098840468	42,30	1	7022098840968	48,70	1
IM + POM SIC KS 90	7022098910168	7022098910268	7022098910368	7022098910468	42,30	1	7022098910968	48,70	1

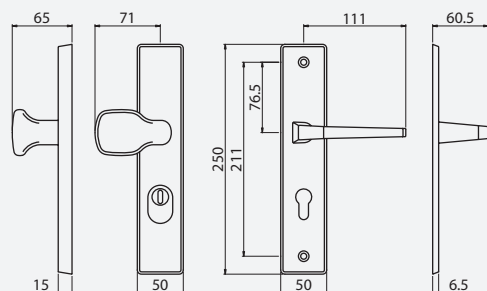

	F1	F2	F3	F4	€	Conf. pz.	F9	€	Conf. pz.
IM + PS SIC KS 72	7022099120168	7022099120268	7022099120368	7022099120468	42,90	1	7022099120968	49,40	1
IM + PS SIC KS 88	7022099080168	7022099080268	7022099080368	7022099080468	42,90	1	7022099080968	49,40	1
IM + PS SIC KS 90	7022099110168	7022099110268	7022099110368	7022099110468	42,90	1	7022099110968	49,40	1

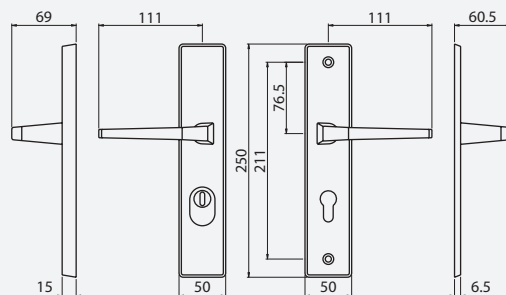

	F1	F2	F3	F4	€	Conf. pz.	F9	€	Conf. pz.
IM + IM SIC KS 72	7022098980168	7022098980268	7022098980368	7022098980468	41,30	1	7022098980968	47,50	1
IM + IM SIC KS 88	7022098880168	7022098880268	7022098880368	7022098880468	41,30	1	7022098880968	47,50	1
IM + IM SIC KS 90	7022098920168	7022098920268	7022098920368	7022098920468	41,30	1	7022098920968	47,50	1

6008

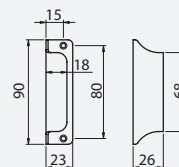

	F1	F2	F3	F4	€	Conf. pz.
MANIGLIETTA	76008612001	76008612002	76008612003	76008612004	3,50	50

6010

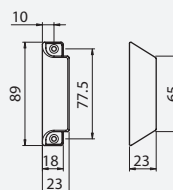

	F1	F2	F3	F4	€	Conf. pz.
MANIGLIETTA	76010612001	76010612002	76010612003	76010612004	4,10	50

GHIDINI STEEL

MANIGLIE

DOOR HANDLES

GINEVRA	388
STTEL 1	390
STEEL 1L	391
STEEL 3	392
STEEL 4	393
STEEL 5	394
STEEL 6	395
STEEL 7	396
STEEL 8	397
STEEL 8Q	398

COORDINATI E COMPLEMENTI D'ARREDO

FURNITURE FITTINGS

BOCCHETTE	399
MANIGLIA INCASSO	400
PICTOGRAMMI	401
POMELLO FERMAPORTA	400

MANIGLIONI

PULL HANDLES

GINEVRA	402
STEEL 100	403
STEEL 101	403
STEEL 102	404
STEEL 103	404
STEEL 104	405
STEEL 105	406
STEEL 106	406
STEEL 107	407
STEEL 108	407
STEEL 109	408
STEEL 110	408
STEEL 111	409
STEEL 112	409
STEEL 113	410
STEEL 114	410
STEEL 115	411
STEEL 116	411
STEEL 117	412
STEEL 118	412
STEEL 119	413

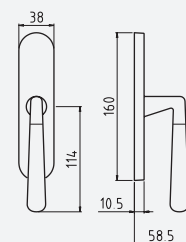
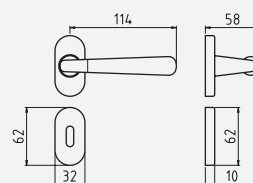
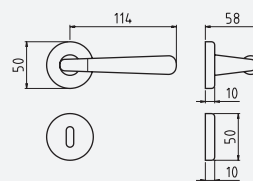

GIOCO FISSO
DISPONIBILE ANCHE CON 8
SCATTI PER MICROVENTILAZIONE

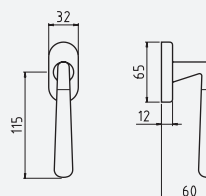

DISPONIBILE FINO AD ESAURIMENTO SCORTE

	INOX	Conf. pz.
Q8 R Guarnitura Q8 ros. senza bocc. <i>Lever handle Q8 on rose</i>	55846280055 59,50	1
Q8 RB Guarnitura Q8 ros./bocc. patent <i>Lever handle Q8 on rose-key escutcheon</i>	55846281055 64,90	1
Q8 RBY Guarnitura Q8 ros./bocc. Yale <i>Lever handle Q8 on rose-cyl escutcheon</i>	55846285055 64,90	1
Q8 ROC Guarnitura Q8 ros.ovale senza bocc. <i>Lever handle Q8 on oval rose</i>	55846220555 65,40	1
Q8 RBOC Guarnitura Q8 ros/bocc.ovale patent <i>Lever handle Q8 on oval rose-key escutcheon</i>	55846221555 71,40	1
Q8 RBOYC Guarnitura Q8 ros/bocc.ovale Yale <i>Lever handle Q8 on oval rose-cyl escutcheon</i>	55846225555 71,40	1
EZ IM Cremonese gioco EZ imp. maniglia <i>Window handle Q7 with mechanism-lever handle</i>	55846456055 34,20	2
EZQ7 IM Cremonese gioco EZ + Q7 imp. maniglia <i>Window handle Q7 with mechanism-lever handle</i>	55846457055 34,60	2
MART IM Martellina Q7 imp. maniglia <i>Window handle Q7 -lever handle</i>	55846550055 34,20	2
DK x 40 Martellina DK Q7 x 40 <i>Window handle Q7 DK-tilt & turn handle</i>	55846557055 34,20	2
DK x 40 C/BUSS. Martellina DK Q7 x 40 con bussole D. 9,5 <i>Window handle Q7 DK-tilt & turn handle with pins d.9,5</i>	55846558055 34,20	2



Guarnitura con sottorosetta in Acciaio inox, viti passanti, grano in testa e molla di richiamo.
 Guarnitura con rosetta ovale coprivite fornita con molla ambidestra.

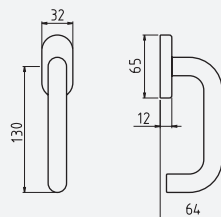
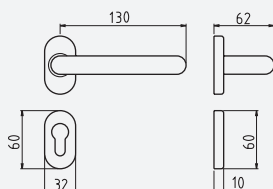
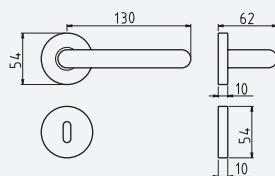

	INOX	Conf. pz.
Q8 R Guarnitura Q8 ros. senza bocc. <i>Lever handle Q8 on rose</i>	99546280055 32,40	1
Q8 RB Guarnitura Q8 ros./bocc. patent <i>Lever handle Q8 on rose-key escutcheon</i>	99546281055 43,00	1
Q8 RBY Guarnitura Q8 ros./bocc. Yale <i>Lever handle Q8 on rose-cyl escutcheon</i>	99546285055 43,00	1
Q8 RBWC Guarnitura Q8 ros./bocc.Wc <i>Lever handle Q8 on rose-WC function</i>	99546288055 59,50	1
Q8 ROC Guarnitura Q8 ros.ovale senza bocc. <i>Lever handle Q8 on oval rose</i>	99546220555 32,40	1
Q8 RBOYC Guarnitura Q8 ros/bocc.ovale Yale <i>Lever handle Q8 on oval rose-cyl escutcheon</i>	99546225555 43,00	1
DK x 40-35 G/F Martellina DK Q7 x 40-35 gioco fisso <i>Window handle Q7 DK-tilt & turn handle</i>	99546557055 30,80	2
DK x 40 C/BUSS. Martellina DK Q7 x 40 con bussole D. 9,5 <i>Window handle Q7 DK-tilt & turn handle with pins d. 9,5</i>	99546558055 30,80	2



Guarnitura con sottorosetta in Acciaio inox, viti passanti, grano in testa e molla di richiamo. Guarnitura con rosetta ovale coprivite fornita con molla ambidestra.

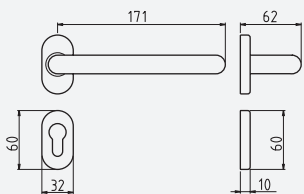
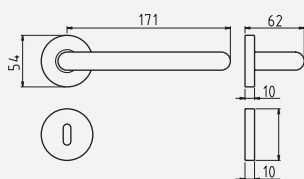

	INOX	Conf. pz.
Q8 R Guarnitura Q8 ros. senza bocc. <i>Lever handle Q8 on rose</i>	99544280055 74,90	1
Q8 RB Guarnitura Q8 ros./bocc. patent <i>Lever handle Q8 on rose-key escutcheon</i>	99544281055 85,50	1
Q8 RBY Guarnitura Q8 ros./bocc. Yale <i>Lever handle Q8 on rose-cyl escutcheon</i>	99544285055 85,50	1
Q8 RBWC Guarnitura Q8 ros./bocc.Wc <i>Lever handle Q8 on rose-WC function</i>	99544288055 102,00	1
Q8 ROC Guarnitura Q8 ros.ovale senza bocc. <i>Lever handle Q8 on oval rose</i>	99544220555 74,90	1
Q8 RBOYC Guarnitura Q8 ros/bocc.ovale Yale <i>Lever handle Q8 on oval rose-cyl escutcheon</i>	99544225555 85,50	1

DISPONIBILE FINO AD ESAURIMENTO SCORTE

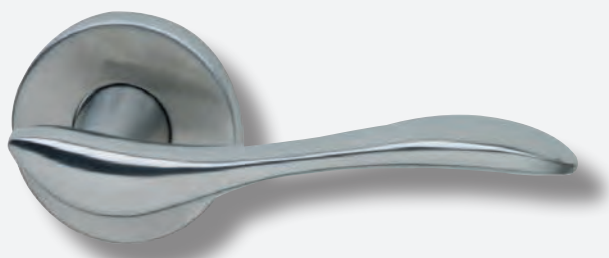

Guarnitura con sottorosetta in Acciaio inox, viti passanti, grano in testa e molla di richiamo.
 Guarnitura con rosetta ovale coprivate fornita con molla ambidestra.

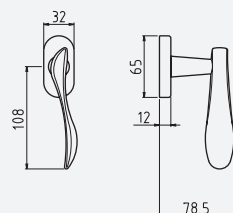
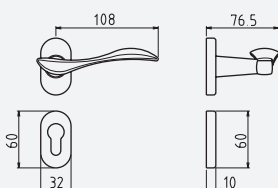
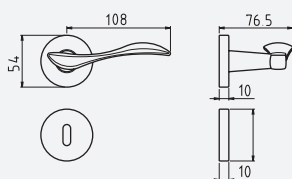

	INOX	Conf. pz.
Q8 R Guarnitura Q8 ros. senza bocc. <i>Lever handle Q8 on rose</i>	99540280055 82,10	1
Q8 RB Guarnitura Q8 ros./bocc. patent <i>Lever handle Q8 on rose-key escutcheon</i>	99540281055 92,60	1
Q8 RBY Guarnitura Q8 ros./bocc. Yale <i>Lever handle Q8 on rose-cyl escutcheon</i>	99540285055 92,60	1
Q8 RBWC Guarnitura Q8 ros./bocc.Wc <i>Lever handle Q8 on rose-WC function</i>	99540288055 109,10	1
Q8 ROC Guarnitura Q8 ros.ovale senza bocc. <i>Lever handle Q8 on oval rose</i>	99540220555 82,10	1
Q8 RBOYC Guarnitura Q8 ros/bocc.ovale Yale <i>Lever handle Q8 on oval rose-cyl escutcheon</i>	99540225555 92,60	1
DK x 40-35 G/F Martellina DK Q7 x 40-35 gioco fisso <i>Window handle Q7 DK-tilt & turn handle</i>	99540557055 51,30	2
DK x 40 C/BUSS. Martellina DK Q7 x 40 con bussole D. 9,5 <i>Window handle Q7 DK-tilt & turn handle with pins d. 9,5</i>	99540558055 51,30	2

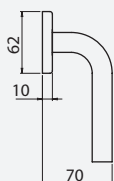
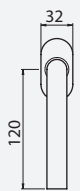
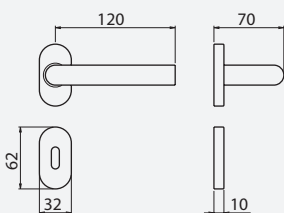
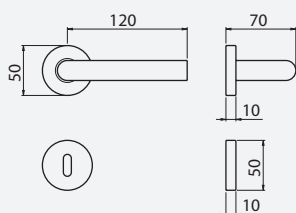

	INOX	Conf. pz.
Q8 R Guarnitura Q8 ros. senza bocc. <i>Lever handle Q8 on rose</i>	99538280055 32,40	1
Q8 RB Guarnitura Q8 ros./bocc. patent <i>Lever handle Q8 on rose-key escutcheon</i>	99538281055 43,00	1
Q8 RBY Guarnitura Q8 ros./bocc. Yale <i>Lever handle Q8 on rose-cyl escutcheon</i>	99538285055 43,00	1
Q8 RBWC Guarnitura Q8 ros./bocc.Wc <i>Lever handle Q8 on rose-WC function</i>	99538288055 59,50	1
Q8 ROC Guarnitura Q8 ros.ovale senza bocc. <i>Lever handle Q8 on oval rose</i>	99538220555 32,40	1
Q8 RBOYC Guarnitura Q8 ros/bocc.ovale Yale <i>Lever handle Q8 on oval rose-cyl escutcheon</i>	99538225555 43,00	1
DK x 40 Martellina DK Q7 x 40 <i>Window handle Q7 DK-tilt & turn handle</i>	99538557055 30,80	2
DK x 40 C/BUSS. Martellina DK Q7 x 40 con bussole D. 9,5 <i>Window handle Q7 DK-tilt & turn handle with pins d. 9,5</i>	99538558055 30,80	2

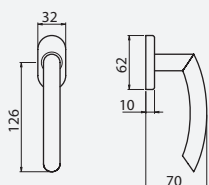
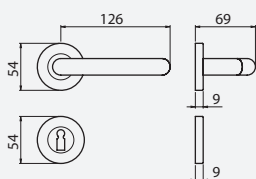
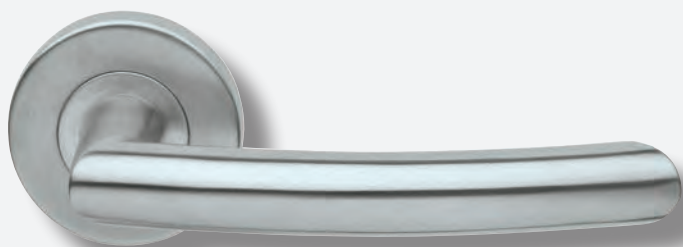

	INOX	Conf. pz.
Q8 R Guarnitura Q8 ros. senza bocc. <i>Lever handle Q8 on rose</i>	99536280055 19,10	1
Q8 RB Guarnitura Q8 ros./bocc. patent <i>Lever handle Q8 on rose-key escutcheon</i>	99536281055 23,30	1
Q8 RBY Guarnitura Q8 ros./bocc. Yale <i>Lever handle Q8 on rose-cyl escutcheon</i>	99536285055 23,30	1
Q8 RBWC Guarnitura Q8 ros./bocc.Wc <i>Lever handle Q8 on rose-WC function</i>	99536288055 39,80	1
DK x 40 Martellina DK Q7 x 40 <i>Window handle Q7 DK-tilt & turn handle</i>	99536557055 15,20	2
DK x 40 C/BUSS. Martellina DK Q7 x 40 con bussole D. 9,5 <i>Window handle Q7 DK-tilt & turn handle with pins d. 9,5</i>	99536558055 15,20	2

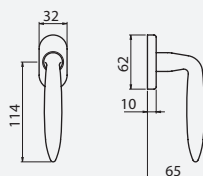
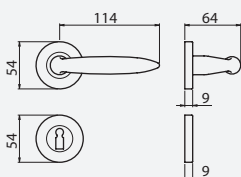

	INOX	Conf. pz.
Q8 R Guarnitura Q8 ros. senza bocc. <i>Lever handle Q8 on rose</i>	99534280055 26,00	1
Q8 RB Guarnitura Q8 ros./bocc. patent <i>Lever handle Q8 on rose-key escutcheon</i>	99534281055 30,20	1
Q8 RBY Guarnitura Q8 ros./bocc. Yale <i>Lever handle Q8 on rose-cyl escutcheon</i>	99534285055 30,20	1
Q8 RBWC Guarnitura Q8 ros./bocc.Wc <i>Lever handle Q8 on rose-WC function</i>	99534288055 46,80	1
DK x 40 Martellina DK Q7 x 40 <i>Window handle Q7 DK-tilt & turn handle</i>	99534557055 16,50	2
DK x 40 C/BUSS. Martellina DK Q7 x 40 con bussole D. 9,5 <i>Window handle Q7 DK-tilt & turn handle with pins d. 9,5</i>	99534558055 16,50	2

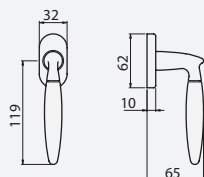
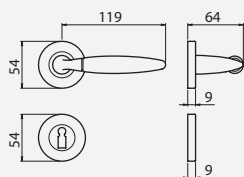
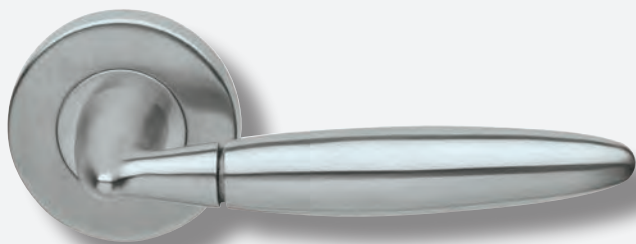

	INOX	Conf. pz.
Q8 R Guarnitura Q8 ros. senza bocc. <i>Lever handle Q8 on rose</i>	99532280055 31,80	1
Q8 RB Guarnitura Q8 ros./bocc. patent <i>Lever handle Q8 on rose-key escutcheon</i>	99532281055 36,00	1
Q8 RBY Guarnitura Q8 ros./bocc. Yale <i>Lever handle Q8 on rose-cyl escutcheon</i>	99532285055 36,00	1
Q8 RBWC Guarnitura Q8 ros./bocc.Wc <i>Lever handle Q8 on rose-WC function</i>	99532288055 52,60	1
DK x 40 Martellina DK Q7 x 40 <i>Window handle Q7 DK-tilt & turn handle</i>	99532557055 19,10	2
DK x 40 C/BUSS. Martellina DK Q7 x 40 con bussole D. 9,5 <i>Window handle Q7 DK-tilt & turn handle with pins d. 9,5</i>	99532558055 19,10	2

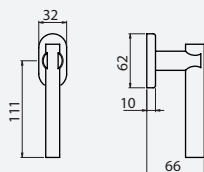
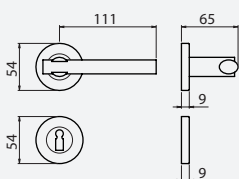

	INOX	Conf. pz.
Q8 R Guarnitura Q8 ros. senza bocc. <i>Lever handle Q8 on rose</i>	99530280055 37,00	1
Q8 RB Guarnitura Q8 ros./bocc. patent <i>Lever handle Q8 on rose-key escutcheon</i>	99530281055 41,20	1
Q8 RBY Guarnitura Q8 ros./bocc. Yale <i>Lever handle Q8 on rose-cyl escutcheon</i>	99530285055 41,20	1
Q8 RBWC Guarnitura Q8 ros./bocc.Wc <i>Lever handle Q8 on rose-WC function</i>	99530288055 57,70	1
DK x 40 Martellina DK Q7 x 40 <i>Window handle Q7 DK-tilt & turn handle</i>	99530557055 24,20	2
DK x 40 C/BUSS. Martellina DK Q7 x 40 con bussole D. 9,5 <i>Window handle Q7 DK-tilt & turn handle with pins d. 9,5</i>	99530558055 24,20	2

DISPONIBILE FINO AD ESAURIMENTO SCORTE

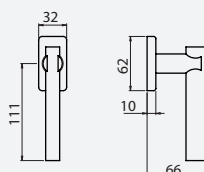
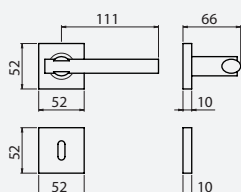

	INOX	Conf. pz.
Q8 R Guarnitura Q8 ros. senza bocc. <i>Lever handle Q8 on rose</i>	99528280055 37,00	1
Q8 RB Guarnitura Q8 ros./bocc. patent <i>Lever handle Q8 on rose-key escutcheon</i>	99528281055 41,20	1
Q8 RBY Guarnitura Q8 ros./bocc. Yale <i>Lever handle Q8 on rose-cyl escutcheon</i>	99528285055 41,20	1
Q8 RBWC Guarnitura Q8 ros./bocc.Wc <i>Lever handle Q8 on rose-WC function</i>	99528288055 57,70	1
DK x 40 Martellina DK Q7 x 40 <i>Window handle Q7 DK-tilt & turn handle</i>	99528557055 24,20	2
DK x 40 C/BUSS. Martellina DK Q7 x 40 con bussole D. 9,5 <i>Window handle Q7 DK-tilt & turn handle with pins d. 9,5</i>	99528558055 24,20	2

BOCCHETTE

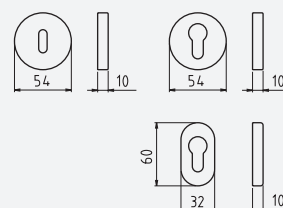

BOC PAT
Bocchetta patent
Key escutcheon

INOX

99548631055

5,30

BOC YALE
Bocchetta yale
Cyl. key escutcheon

99548635055

5,30

BOC OVALE YALE
Bocchetta ovale yale
Oval cyl. key escutcheon

99548625055

5,30

NOTTOLINO

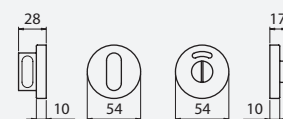

NOTT RWC
Nottolino WC Q.6 con rosette
Toilet set - spindle 6 mm. with roses

INOX

99548638055

29,10

FERMAPORTE

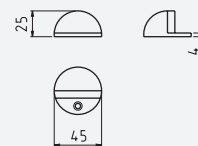

POM F/POR GOMMA
Pomello fermaporta con gommino
Stop door

INOX
99548340055
15,90

MANIGLIA INCASSO

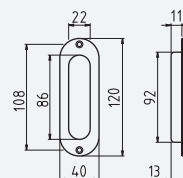

INCAS OVALE S/F
Maniglia incasso chiusa
Sliding door handle

INOX
99548700055
13,70

PICTOGRAMMI



	INOX
PICTOGRAMMA DONNA Pictogramma DONNA con viti in vista	99548310055 13,70
PICTOGRAMMA UOMO Pictogramma UOMO con viti in vista	99548310155 13,70
PICTOGRAMMA HANDICAP Pictogramma HANDICAP con viti in vista	99548310255 13,70
PICTOGRAMMA PUSH Pictogramma PUSH con viti in vista	99548310355 13,70
PICTOGRAMMA PULL Pictogramma PULL con viti in vista	99548310455 13,70

GINEVRA

Design: Fabrizio Bianchetti

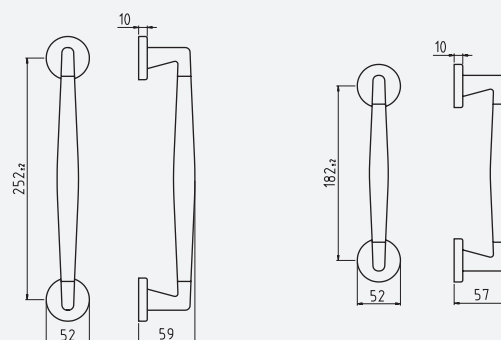

	INOX	Conf. pz.
MAN DIR R MM 252 Maniglione diritto su rosetta mm. 252 <i>Straight pull handle on rose</i>	55846602055	1
	68,40	
MAN DIR R MM 182 Maniglione diritto su rosetta mm. 182 <i>Straight pull handle on rose</i>	55846604055	1
	59,80	

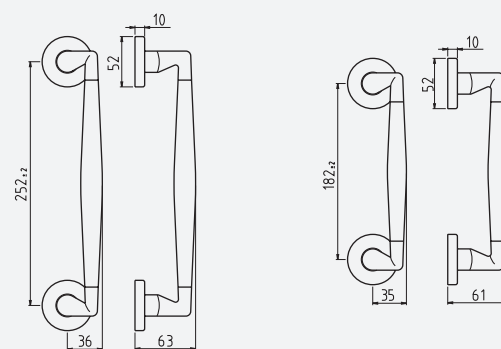

	INOX	Conf. pz.
MAN ZAN R MM 252 Maniglione zancato su rosetta mm. 252 <i>Offset pull handle on rose</i>	55846612055	1
	68,40	
MAN ZAN R MM 182 Maniglione zancato su rosetta mm. 182 <i>Offset pull handle on rose</i>	55846614055	2
	59,80	

STEEL 100

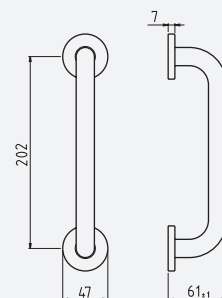

MAN DIR
Maniglione diritto
Straight pull handle

INOX	Conf. pz.
99546602055	2
26,50	

STEEL 101

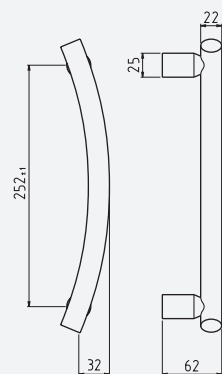

MAN ZAN
Maniglione zancato completo di fissaggio
Offset pull handle

INOX	Conf. pz.
99542601255	1
82,10	



STEEL 102

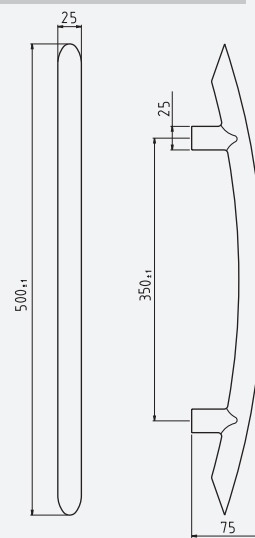

Spessore porta 8-65 mm.

	INOX	Conf. pz.
MAN DIR Maniglione diritto completo di fissaggio <i>Straight pull handle</i>	99544600255	1
MAN DIR CP Maniglione diritto accoppiato completo di fissaggio <i>Straight pull handle</i>	99544600755	1

STEEL 103

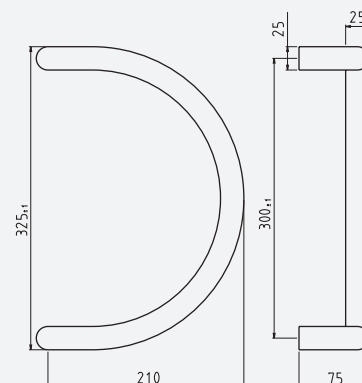

Spessore porta 8-65 mm.

	INOX	Conf. pz.
MAN ZAN TON Maniglione zancato tondo completo di fissaggio <i>Offset pull handle</i>	99546662055	1
MAN ZAN CP TON Maniglione zancato tondo acc.completo di fissaggio <i>Offset pull handle</i>	99546660755	1

STEEL 104

DISPONIBILE FINO AD ESAURIMENTO SCORTE

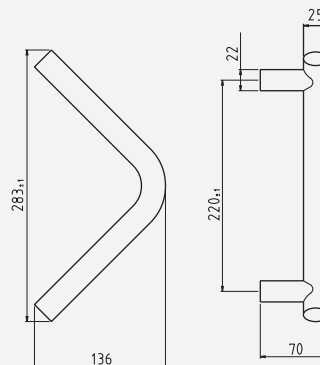

	INOX	Conf. pz.
MAN TON Maniglione tondo completo di fissaggio <i>Offset pull handle</i>	99542662055 119,10	1
MAN CP TON Maniglione tondo acc.completo di fissaggio <i>Offset pull handle</i>	99542660755 238,10	1

STEEL 105

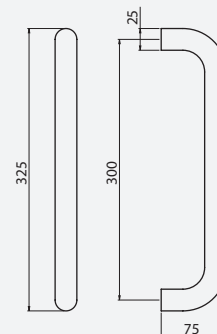

	INOX	Conf. pz.
MAN DIR Maniglione diritto con fissaggi <i>Straight pull handle</i>	99536600255 50,20	1
MAN DIR CP Maniglioni diritti accoppiati con fissaggi <i>Straight pull handle back to back</i>	99536600755 100,40	1

STEEL 106

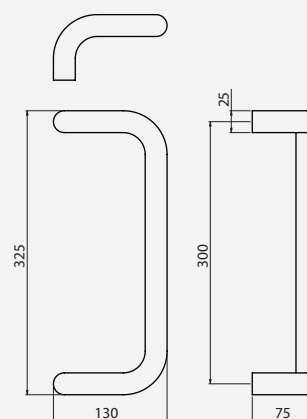

	INOX	Conf. pz.
MAN ZAN DIR Maniglione zancato diritto con fissaggi <i>Offset pull handle</i>	99536610255 69,70	1
MAN ZAN CP DIR Maniglioni zancati diritti accoppiati con fissaggi <i>Offset pull handle back to back</i>	99536610755 139,40	1



STEEL 107

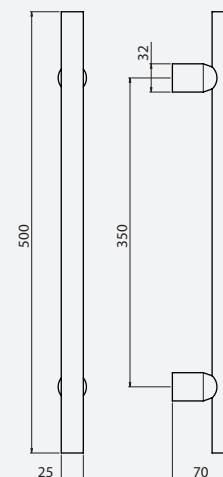

	INOX	Conf. pz.
MAN DIR Maniglione diritto con fissaggi <i>Straight pull handle</i>	99532600255	1
MAN DIR CP Maniglioni diritti accoppiati con fissaggi <i>Straight pull handle back to back</i>	99532600755	1



STEEL 108

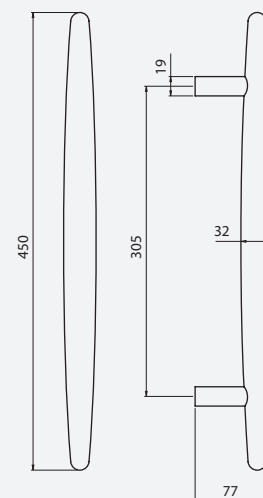

	INOX	Conf. pz.
MAN DIR Maniglione diritto con fissaggi <i>Straight pull handle</i>	99530600255	1
MAN DIR CP Maniglioni diritti accoppiati con fissaggi <i>Straight pull handle back to back</i>	99530600755	1

STEEL 109

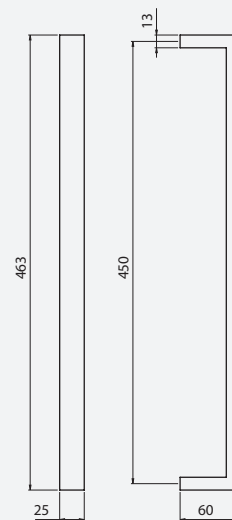
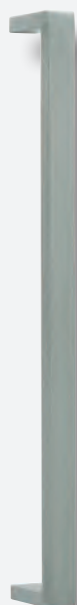

	INOX	Conf. pz.
MAN DIR Maniglione diritto con fissaggi <i>Straight pull handle</i>	99534600255	1
	77,40	
MAN DIR CP Maniglioni diritti accoppiati con fissaggi <i>Straight pull handle back to back</i>	99534600755	1
	154,80	

STEEL 110

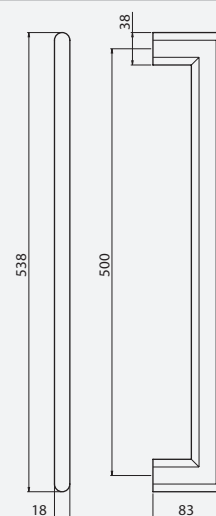

	INOX	Conf. pz.
MAN DIR Maniglione diritto con fissaggi <i>Straight pull handle</i>	99528600255	1
	93,70	
MAN DIR CP Maniglioni diritti accoppiati con fissaggi <i>Straight pull handle back to back</i>	99528600755	1
	187,30	

STEEL 111

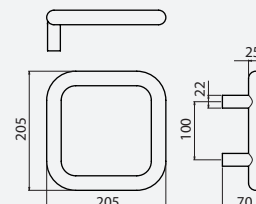

	INOX	Conf. pz.
MAN Maniglione con fissaggi <i>Pull handle</i>	99516600255	1
	89,00	
MAN CP Maniglioni accoppiati con fissaggi <i>Pull handle back to back</i>	99516600755	1
	178,10	

STEEL 112

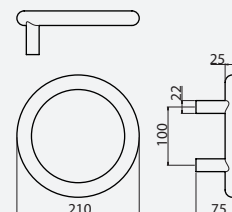

	INOX	Conf. pz.
MAN Maniglione con fissaggi <i>Pull handle</i>	99514600255	1
	87,70	
MAN CP Maniglioni accoppiati con fissaggi <i>Pull handle back to back</i>	99514600755	1
	175,40	

STEEL 113

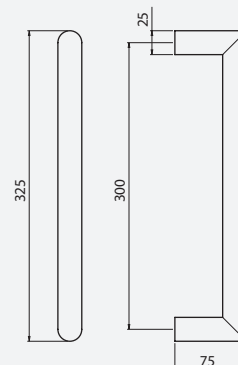

	INOX	Conf. pz.
MAN DIR Maniglione diritto con fissaggi <i>Straight pull handle</i>	99538600255	1
	54,50	
MAN DIR CP Maniglioni diritti accoppiati con fissaggi <i>Straight pull handle back to back</i>	99538600755	1
	109,00	

STEEL 114

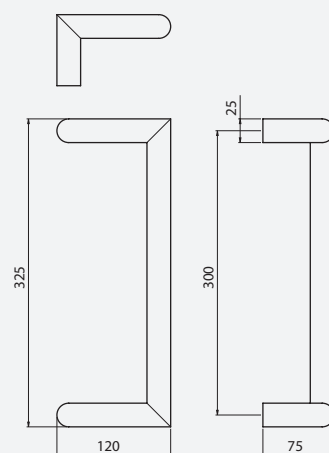

	INOX	Conf. pz.
MAN ZAN DIR Maniglione zancato diritto con fissaggi <i>Offset pull handle</i>	99538610255	1
	79,40	
MAN ZAN DIR CP Maniglioni zancati diritti accoppiati con fissaggi <i>Offset pull handle back to back</i>	99538610755	1
	158,80	

STEEL 115

Acciaio massiccio
 Solid steel

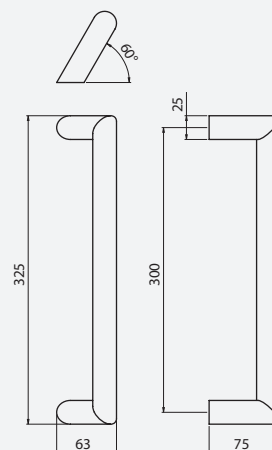

	INOX	Conf. pz.
MAN ZAN DIR Maniglione zancato diritto con fissaggi <i>Offset pull handle</i>	99526610255 60,90	1
MAN ZAN DIR CP Maniglioni zancati diritti accoppiati con fissaggi <i>Offset pull handle back to back</i>	99526610755 121,80	1

STEEL 116

Acciaio massiccio
 Solid steel

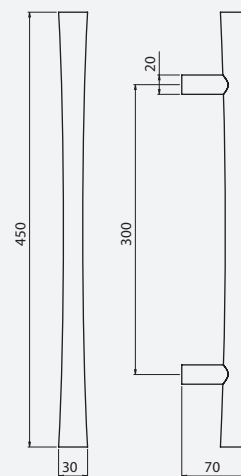

	INOX	Conf. pz.
MAN DIR Maniglione diritto con fissaggi <i>Straight pull handle</i>	99524600255 382,80	1
MAN DIR CP Maniglioni diritti accoppiati con fissaggi <i>Straight pull handle back to back</i>	99524600755 765,70	1



STEEL 117

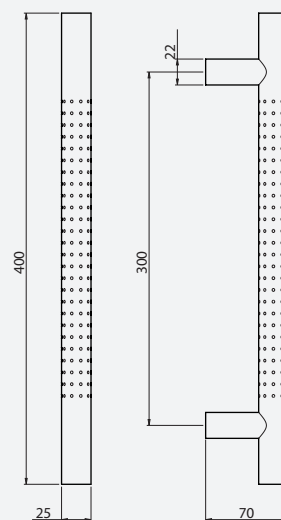

	INOX	Conf. pz.
MAN DIR Maniglione diritto con fissaggi <i>Straight pull handle</i>	99522600255	1
	81,60	
MAN DIR CP Maniglioni diritti accoppiati con fissaggi <i>Straight pull handle back to back</i>	99522600755	1
	163,20	

STEEL 118

DISPONIBILE FINO AD ESAURIMENTO SCORTE

Acciaio massiccio
Solid steel

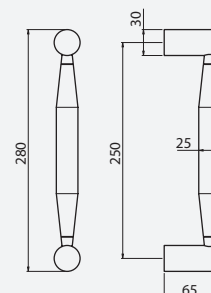

	INOX	Conf. pz.
MAN DIR Maniglione diritto con fissaggi <i>Straight pull handle</i>	99520600255	1
	225,20	
MAN DIR CP Maniglioni diritti accoppiati con fissaggi <i>Straight pull handle back to back</i>	99520600755	1
	450,50	

STEEL 119

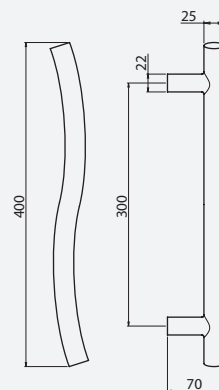

	INOX	Conf. pz.
MAN DIR Maniglione diritto con fissaggi <i>Straight pull handle</i>	99518600255 76,30	1
MAN DIR CP Maniglioni diritti accoppiati con fissaggi <i>Straight pull handle back to back</i>	99518600755 152,70	1



MANIGLIE E COORDINATI IN NYLON NYLON DOOR HANDLES AND ACCESSORIES

MANIGLIE DOOR HANDLES

GIOVE	419
LIA	417
MINNY	416
ROMY	418

POMOLI KNOB

LIA	419
MINNY	423
PIPPA	423

MANIGLIONI PULL HANDLES

LIA DIRITTO	424
LIA ZANCATO	425
FISSAGGI	426

COORDINATI E COMPLEMENTI D'ARREDO FURNITURE FITTINGS

BOCCHETTE	420
COPRIAVVOLGIBILI	430
COPRINTERRUTORI	429
NOTTOLINO WC	421
MANIGLIE DA INCASSO	422
PLACCHE	421
PORTABITI	427-428
ROSETTE	420

MINNY



NNE

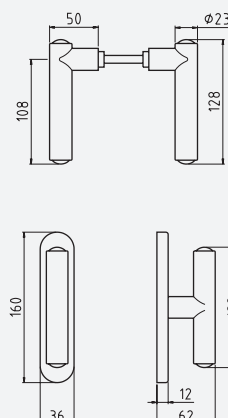

Colori disponibili a magazzino: nero, bianco.

Per tutti gli altri colori richiedere, di volta in volta, fattibilità e tempi di consegna.

Tutte le versioni cremonesi e martellina sono realizzabili applicando al CREM/MART SG i giochi disponibili a pag. 245.

	NGI	NGR	NAM	NVE	Conf. pz.
Q8 BIL	88940208001	88940208002	88940208003	88940208004	
Coppia maniglie con Q8 (Bilancino)					8
<i>Pair of levers handle without eschutcheon spindle Q8</i>	5,00	5,00	5,00	5,00	
CREM/MART SG	88940400001	88940400002	88940400003	88940400004	
Cremonese-Martellina senza gioco					10
<i>Window handle Q7 without mechanism</i>	4,80	4,80	4,80	4,80	
	NNE	NMA	NBI	NRO	Conf. pz.
Q8 BIL	88940208005	88940208006	88940208007	88940208008	
Coppia maniglie con Q8 (Bilancino)					8
<i>Pair of levers handle without eschutcheon spindle Q8</i>	5,00	5,00	5,00	5,00	
CREM/MART SG	88940400005	88940400006	88940400007	88940400008	
Cremonese-Martellina senza gioco					10
<i>Window handle Q7 without mechanism</i>	4,80	4,80	4,80	4,80	

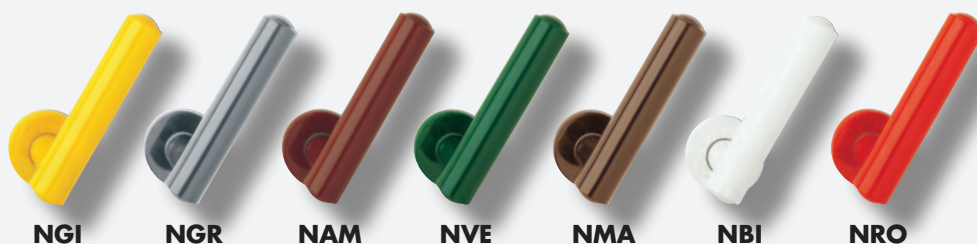

LIA



NNE

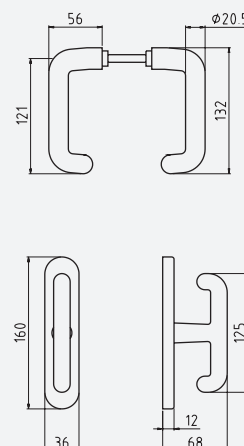

Colori disponibili a magazzino: nero, bianco.

Per tutti gli altri colori richiedere, di volta in volta, fattibilità e tempi di consegna.

Tutte le versioni cremonesi e martellina sono realizzabili applicando al CREM/MART SG i giochi disponibili a pag. 245.

	NGI	NGR	NAM	NVE	Conf. pz.
Q8 BIL	88944208001	88944208002	88944208003	88944208004	8
Coppia maniglie con Q8 (Bilancino)	6,40	6,40	6,40	6,40	
<i>Pair of levers handle without eschutcheon spindle Q8</i>					
CREM/MART SG	88944400001	88944400002	88944400003	88944400004	10
Cremonese-Martellina senza gioco	5,50	5,50	5,50	5,50	
<i>Window handle Q7 without mechanism</i>					
	NNE	NMA	NBI	NRO	Conf. pz.
Q8 BIL	88944208005	88944208006	88944208007	88944208008	8
Coppia maniglie con Q8 (Bilancino)	6,40	6,40	6,40	6,40	
<i>Pair of levers handle without eschutcheon spindle Q8</i>					
CREM/MART SG	88944400005	88944400006	88944400007	88944400008	10
Cremonese-Martellina senza gioco	5,50	5,50	5,50	5,50	
<i>Window handle Q7 without mechanism</i>					



NGI

NGR

NAM

NVE

NMA

NBI

NRO

ROMY

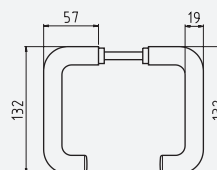

NNE

Colori disponibili a magazzino: nero, bianco.

Per tutti gli altri colori richiedere, di volta in volta, fattibilità e tempi di consegna.

	NGR	NNE	NBI	NRO	Conf. pz.
Q8 BIL	88934208002	88934208005	88934208007	88934208008	8
Coppia maniglie con Q8 (Bilancino)	12,00	12,00	12,00	12,00	
<i>Pair of levers handle without eschutcheon spindle Q8</i>					



NGR

NBE

NRO

GIOVE

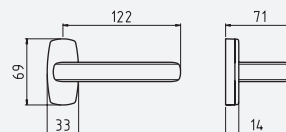
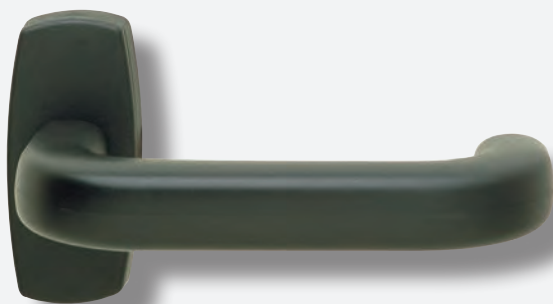

Guarnitura per il serramento in alluminio con doppia molla di ritorno ambidestra e doppio grano.

	NNE	Conf. pz.
Q8 RR	88894210005	
Guarnitura Q8 rosetta rettangolare		6
<i>Lever handle Q8 on rose</i>	11,30	

LIA

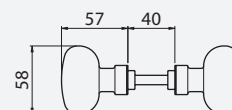

	NNE	NBI	Conf. pz.
POM55 Q8 BIL	88944751905	88944751907	
Coppia pomoli mm. 55 Q8			8
<i>Pair of knobs dia.55mm Q8</i>	10,40	10,40	

MINNY



	NGI	NGR	NAM	NVE	NNE	NMA	NBI	NRO	Conf. pz.
ROS TONDA	88948531001	88948531002	88948531003	88948531004	88948531005	88948531006	88948531007	88948531008	16
Rosetta tonda <i>Rose</i>	1,20	1,20	1,20	1,20	1,20	1,20	1,20	1,20	
BOC TONDA PAT	88948631001	88948631002	88948631003	88948631004	88948631005	88948631006	88948631007	88948631008	16
Bocchetta tonda Patent <i>Eschutcheon patent</i>	1,20	1,20	1,20	1,20	1,20	1,20	1,20	1,20	
BOC TONDA YALE	88948635001	88948635002	88948635003	88948635004	88948635005	88948635006	88948635007	88948635008	16
Bocchetta tonda Yale <i>Eschutcheon Yale</i>	1,20	1,20	1,20	1,20	1,20	1,20	1,20	1,20	

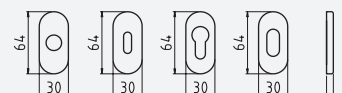

	NGI	NGR	NAM	NVE	NNE	NMA	NBI	NRO	Conf. pz.
ROS OVALE	88948521001	88948521002	88948521003	88948521004	88948521005	88948521006	88948521007	88948521008	16
Rosetta ovale <i>Oval rose</i>	1,20	1,20	1,20	1,20	1,20	1,20	1,20	1,20	
BOC OVALE PAT	88948621001	88948621002	88948621003	88948621004	88948621005	88948621006	88948621007	88948621008	16
Bocchetta ovale Patent <i>Oval eschutcheon patent</i>	1,20	1,20	1,20	1,20	1,20	1,20	1,20	1,20	
BOC OVALE YALE	88948625001	88948625002	88948625003	88948625004	88948625005	88948625006	88948625007	88948625008	16
Bocchetta ovale Yale <i>Oval eschutcheon Yale</i>	1,20	1,20	1,20	1,20	1,20	1,20	1,20	1,20	
BOC OVALE F/O	88948622001	88948622002	88948622003	88948622004	88948622005	88948622006	88948622007	88948622008	16
Bocchetta ovale foro cilindro ovale <i>Oval eschutcheon oval cylinder</i>	1,20	1,20	1,20	1,20	1,20	1,20	1,20	1,20	

MINNY

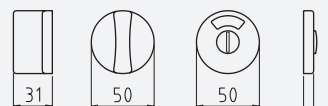

	NGI	NGR	NAM	NVE	NNE	NMA	NBI	NRO	Conf. pz.
NOTT RWC	88948638001	88948638002	88948638003	88948638004	88948638005	88948638006	88948638007	88948638008	
Nottolino WC Q.6 con rosette	8,30	8,30	8,30	8,30	8,30	8,30	8,30	8,30	10
<i>Toilet set - spindle 6 mm.</i>									

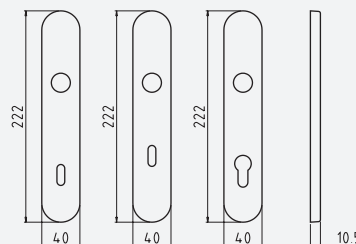

	NGI	NGR	NAM	NVE	NNE	NMA	NBI	NRO	Conf. pz.
P90	88948851001	88948851002	88948851003	88948851004	88948851005	88948851006	88948851007	88948851008	
Placca Patent 90	2,30	2,30	2,30	2,30	2,30	2,30	2,30	2,30	16
<i>Plate with key hole 90</i>									
P70	88948857001	88948857002	88948857003	88948857004	88948857005	88948857006	88948857007	88948857008	
Placca Patent 70	2,30	2,30	2,30	2,30	2,30	2,30	2,30	2,30	16
<i>Plate with key hole 70</i>									
PY85	88948855001	88948855002	88948855003	88948855004	88948855005	88948855006	88948855007	88948855008	
Placca Yale 85	2,30	2,30	2,30	2,30	2,30	2,30	2,30	2,30	16
<i>Plate with cylinder key hole 85</i>									

MINNY

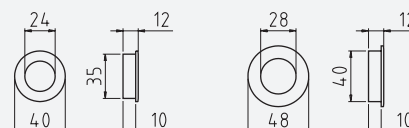
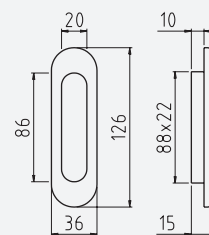

	NGR	NAM	NVE	NNE	NMA	NBI	NRO	Conf. pz.
MINNY INCAS	88948700002	88948700003	88948700004	88948700005	88948700006	88948700007	88948700008	
Maniglia incasso ovale <i>Sliding door oval handle</i>	1,30	1,30	1,30	1,30	1,30	1,30	1,30	24
MINNY INCAS MM 35	88948735002	88948735003	88948735004	88948735005	88948735006	88948735007	88948735008	
Maniglia incasso tonda mm 35 <i>Sliding door round handle</i>	1,30	1,30	1,30	1,30	1,30	1,30	1,30	50
MINNY INCAS MM 40	88948740002	88948740003	88948740004	88948740005	88948740006	88948740007	88948740008	
Maniglia incasso tonda mm 40 <i>Sliding door round handle</i>	1,30	1,30	1,30	1,30	1,30	1,30	1,30	50

PIPPO



	NNE	NMA	NBI	NRO	Conf. pz.
POM70 CP R70	88942770005	88942770006	88942770007	88942770008	8
Pomolo mm 70 centroporta	10,80	10,80	10,80	10,80	
<i>Fixed knob dia .70mm</i>					

MINNY



	NNE	NMA	NBI	NRO	Conf. pz.
POM70 CP R70	88940770005	88940770006	88940770007	88940770008	8
Pomolo mm 70 centroporta	10,80	10,80	10,80	10,80	
<i>Fixed knob dia .70mm</i>					

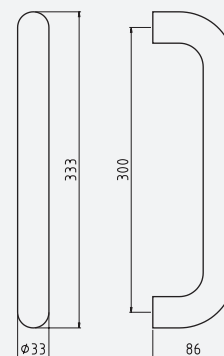

	NGR	NNE	NMA	NBI	NRO	Conf. pz.
MAN 300 DIR Maniglione diritto mm 300 <i>Straight pull handle on rose</i>	88944602002	88944602005	88944602006	88944602007	88944602008	4
	26,00	26,00	26,00	26,00	26,00	

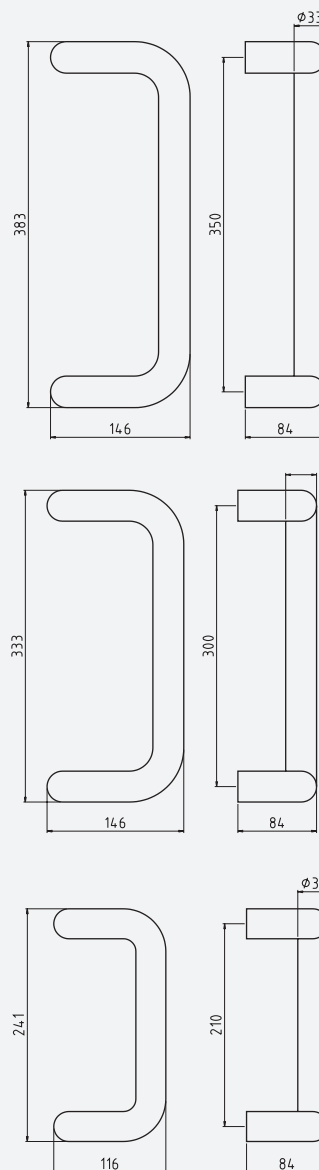

	NGR	NNE	NMA	NBI	NRO	Conf. pz.
MAN 350 ZAN	88944613002	88944613005	88944613006	88944613007	88944613008	
Maniglione zancato mm 350	34,50	34,50	34,50	34,50	34,50	2
<i>Offset pull handle mm. 350</i>						
MAN 300 ZAN	88944612002	88944612005	88944612006	88944612007	88944612008	
Maniglione zancato mm 300	30,10	30,10	30,10	30,10	30,10	2
<i>Offset pull handle mm. 300</i>						
MAN 210 ZAN	n.d.	88944614005	n.d.	88944614007	88944614008	
Maniglione zancato mm 210		26,00		26,00	26,00	2
<i>Offset pull handle mm. 210</i>						



FISSAGGI MANIGLIONI LIA

	NGR			
FISS SING VETRO MAN MM 300/350 Fissaggio singolo per vetro man. mm 300/350 <i>Screw for single pull handle mm.300/350 glass door</i>	88944687002			
	4,50			
FISS SING LEGNO-ALLUM MAN MM 300/350 Fissaggio singolo per legno-alluminio man. mm 300/350 <i>Screw for single pull handle mm.300/350 alu-wood door</i>	88944687502			
	4,50			
FISS DOPP VETRO MAN MM 300/350 Fissaggio doppio per vetro man. mm 300/350 <i>Screw for fixing a pair of pull handle mm300 glass door</i>	88944688002			
	6,40			
FISS DOPP LEGNO-ALLUM MAN MM 300/350 Fissaggio doppio per legno-alluminio man. mm 300/350 <i>Screw for fixing a pair of pull handle mm.300 al-wood door</i>	88944688502			
	6,40			
ROS70 X MAN Rosone D.70 per fissaggio maniglione <i>Fitting for fixing pull handle</i>	88948580002			
	4,50			
	NNE	NMA	NBI	NRO
FISS SING VETRO MAN MM 210 Fissaggio singolo per vetro man. mm 210 <i>Screw for single pull handle mm.210 glass door</i>	88944682005	n.d.	88944682007	88944682008
	4,50		4,50	4,50
FISS SING LEGNO-ALLUM MAN MM 210 Fissaggio singolo per legno-alluminio man. mm 210 <i>Screw for single pull handle mm.210 alu-wood door</i>	88944682505	n.d.	88944682507	88944682508
	4,50		4,50	4,50
FISS SING VETRO MAN MM 300/350 Fissaggio singolo per vetro man. mm 300/350 <i>Screw for single pull handle mm.300/350 glass door</i>	88944687005	88944687006	88944687007	88944687008
	4,50		4,50	4,50
FISS SING LEGNO-ALLUM MAN MM 300/350 Fissaggio singolo per legno-alluminio man. mm 300/350 <i>Screw for single pull handle mm.300/350 alu-wood door</i>	88944687505	88944687506	88944687507	88944687508
	4,50		4,50	4,50
FISS DOPP VETRO MAN MM 210 Fissaggio doppio per vetro man. mm 210 <i>Screw for fixing a pair of pull handle mm.210 glass door</i>	88944683005	n.d.	88944683007	88944683008
	6,40		6,40	6,40
FISS DOPP LEGNO-ALLUM MAN MM 210 Fissaggio doppio per legno-alluminio man. mm 210 <i>Screw for fixing a pair of pull handle mm.210 al-wood door</i>	88944683505	n.d.	88944683507	88944683508
	6,40		6,40	6,40
FISS DOPP VETRO MAN MM 300/350 Fissaggio doppio per vetro man. mm 300/350 <i>Screw for fixing a pair of pull handle mm300 glass door</i>	88944688005	88944688006	88944688007	88944688008
	6,40		6,40	6,40
FISS DOPP LEGNO-ALLUM MAN MM 300/350 Fissaggio doppio per legno-alluminio man. mm 300/350 <i>Screw for fixing a pair of pull handle mm.300 al-wood door</i>	88944688505	88944688506	88944688507	88944688508
	6,40		6,40	6,40
ROS70 X MAN Rosone D.70 per fissaggio maniglione <i>Fitting for fixing pull handle</i>	88948580005	88948580006	88948580007	88948580008
	4,50	4,50	4,50	4,50

DUMBO

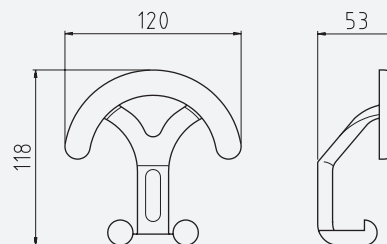

	NGI	NGR	NVE	NNE	NBI	NRO	Conf. pz.
DUMBO PORT	88946690001	88946690002	88946690004	88946690005	88946690007	88946690008	12
Portabito <i>Hat & Coat Hook</i>	4,30	4,30	4,30	4,30	4,30	4,30	

PIPPO

DISPONIBILE FINO AD ESAURIMENTO SCORTE

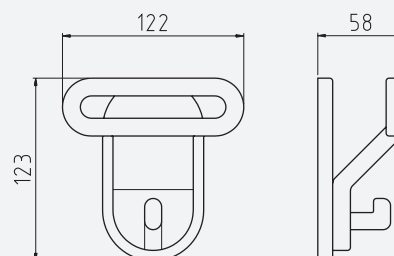

	NGI	NGR	NVE	NNE	NBI	NRO	Conf. pz.
PIPPO PORT	88942690001	88942690002	88942690004	88942690005	88942690007	88942690008	12
Portabito <i>Hat & Coat Hook</i>	6,80	6,80	6,80	6,80	6,80	6,80	

MINNY

DISPONIBILE FINO AD ESAURIMENTO SCORTE

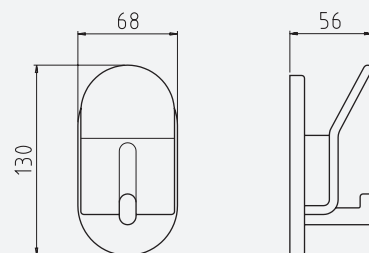

	NGI	NGR	NVE	NNE	NBI	NRO	Conf. pz.
MINNY PORT	88940690001	88940690002	88940690004	88940690005	88940690007	88940690008	12
Portabito	6,80	6,80	6,80	6,80	6,80	6,80	
<i>Hat & Coat Hook</i>							

BAMBY

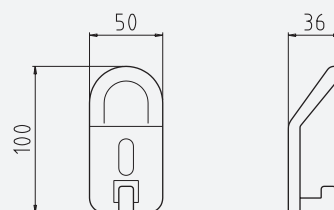

	NGI	NGR	NVE	NNE	NBI	NRO	Conf. pz.
BAMBY PORT	88930690001	88930690002	88930690004	88930690005	88930690007	88930690008	12
Portabito	2,80	2,80	2,80	2,80	2,80	2,80	
<i>Hat & Coat Hook</i>							

MINNY

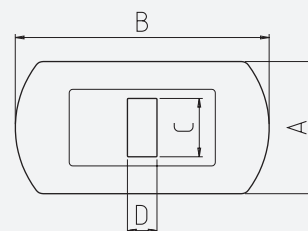

	A	B	C	D
MAGIC 1P	76	146	33,5	17
MAGIC 2P	76	146	33,5	17
MAGIC 3P	76	146	33,5	17
MAGIC 4P	76	170	33,5	17
MAGIC 5P	76	195	33,5	17

	NNE	NBI	Conf. pz.
COPR MAGIC 1P Coprinterruttore Magic 1 posto <i>Switch cover 1 hole</i>	88948900105	88948900107	12
	2,90	2,90	
COPR MAGIC 2P Coprinterruttore Magic 2 posti <i>Switch cover 2 holes</i>	88948900205	88948900207	12
	2,90	2,90	
COPR MAGIC 3P Coprinterruttore Magic 3 posti <i>Switch cover 3 holes</i>	88948900305	88948900307	12
	2,90	2,90	
COPR MAGIC 4P Coprinterruttore Magic 4 posti <i>Switch cover 4 holes</i>	88948900405	88948900407	12
	4,10	4,10	
COPR MAGIC 5P Coprinterruttore Magic 5 posti <i>Switch cover 5 holes</i>	88948900505	88948900507	12
	4,10	4,10	

MINNY

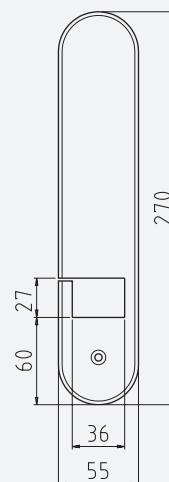

	NNE	NBI	Conf. pz.
AVV	88948800005	88948800007	
Copriavvolgibile	3,70	3,70	12
<i>Cover</i>			

COORDINATI PER PORTE SCORREVOLI SLIDING DOORS ACCESSORIES

MANIGLIE DA INCASSO SLIDING DOOR HANDLES

■	6009	447
■	ELY	433
■	GABRY	447
■	GIOIA OVALE	432
■	GIOIA TONDA	434
■	OVALE COPRIVITI	433
■	R95	435
■	R97	435
■	SCORRI OVALE PICCOLA	432
■	SCORRI TONDO	434
■	SCORRI TONDO	447
■	KIT SMILE	436
■	KIT OVALI OVAL KITS	442-443
■	KIT QUADRI SQUARE KITS	437
■ ■	KIT TONDI ROUNDS KITS	440-441-442
■	KIT TONDI ROUNDS KITS	444-445
■	KIT QUADRI/TONDI SQUARE/ROUNDS KITS	438-439
■	KIT TONDI PENDENTI PENDING KITS	440

SCORRI OVALE PICCOLA



OLV-M1

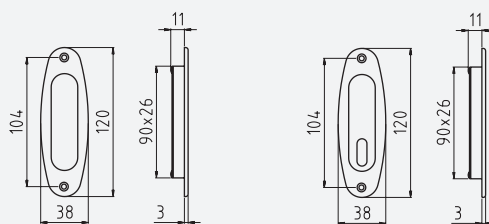

	OBR M45	OLV M1	OCS M18	OCL M4	Conf. pz.
SCORRI OVALE CIECA PIC Incasso ovale cieca piccola <i>Sliding door handle</i>	55498750000	55498750001	55498750003	55498750007	24
	9,10	9,10	10,60	10,60	
SCORRI OVALE PAT PIC Incasso ovale con foro patent piccola <i>Sliding door handle</i>	55498750300	55498750301	55498750303	55498750307	24
	9,10	9,10	10,60	10,60	

GIOIA



OLV-M1

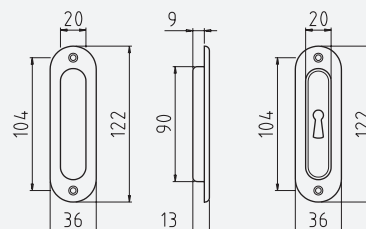

	OLV M1	OCS M18	OGV M27	OCL M4	OLD MV3	Conf. pz.
INCAS S/F Maniglia incasso senza foro chiave <i>Sliding door handle</i>	55448700001	55448700003	55448700004	55448700007	55448700028	24
	8,20	11,00	8,20	11,00	8,20	
INCAS PAT Maniglia incasso foro patent <i>Sliding door handle key hole</i>	55448701001	55448701003	55448701004	55448701007	55448701028	24
	8,20	11,00	8,20	11,00	8,20	

ELY

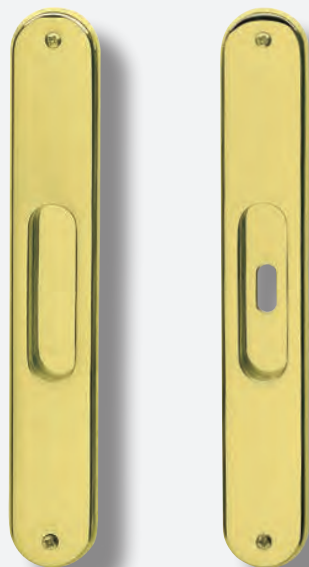

OLV-M1

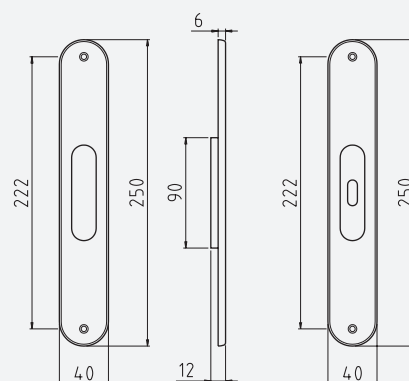

	OLV M1	OCS M18	OGV M27	OCL M4	OS M2	Conf. pz.
PLACC INCAS S/F Placca incasso senza foro chiave <i>Sliding door handle</i>	55048750001	55048750003	55048750004	55048750007	55048750008	24
	11,00	13,70	11,00	13,70	11,00	
PLACC INCAS PAT Placca incasso foro patent <i>Sliding door handle</i>	55048751001	55048751003	55048751004	55048751007	55048751008	24
	11,00	13,70	11,00	13,70	11,00	

OVALE COPRIVITI



OLV-M1

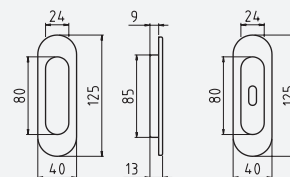

	OLV M1	OCS M18	OGV M27	OCL M4	OS M2	Conf. pz.
INCASSO OVALE COP S/F Maniglia incasso chiusa <i>Sliding door handle</i>	55798700001	55798700003	55798700004	55798700007	55798700008	24
	8,20	11,00	8,20	11,00	8,20	
INCASSO OVALE COP PAT Maniglia incasso foro patent <i>Sliding door handle key hole</i>	55798701001	55798701003	55798701004	55798701007	55798701008	24
	8,20	11,00	8,20	11,00	8,20	

SCORRI TONDO



OLV-M1

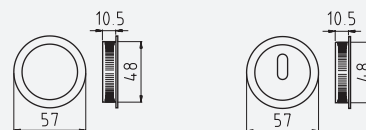

	OBR M45	OLV M1	OCS M18	OCL M4	Conf. pz.
SCORRI TONDA MM 48 CIECA Incasso tonda d.48 cieca <i>Sliding door handle</i>	55748748000	55748748001	55748748003	55748748007	24
SCORRI TONDA MM 48 PAT Incasso tonda d.48 con foro patent spostato <i>Sliding door handle</i>	55748746000	55748746001	55748746003	55748746007	24

GIOIA



OLV-M1

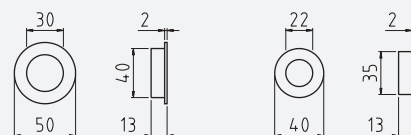

	OLV M1	OCS M18	OGV M27	OCL M4	OS M2	Conf. pz.
INCAS MM 35 TON Maniglia incasso tonda mm 35 <i>Sliding door handle</i>	55448735001	55448735003	55448735004	55448735007	55448735008	50
INCAS MM 40 TON Maniglia incasso tonda mm 40 <i>Sliding door handle</i>	55448740001	55448740003	55448740004	55448740007	55448740008	50

R95



OLV-M1

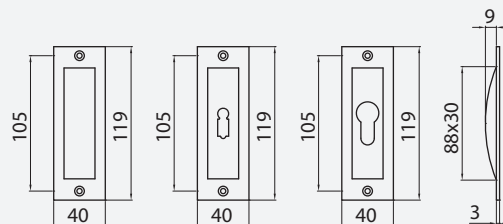

	OLV M1	OCS M18	OF M3	OCL M4	ONS M9	ONL M7	Conf. pz.
INCASSO S/F Maniglia incasso senza foro chiave <i>Sliding door handle</i>	R009500000001	R009500000003	R009500000006	R009500000007	R009500000027	R009500000030	24
	11,30	13,60	12,30	13,60	14,30	13,60	
INCASSO BB Maniglia incasso foro BB <i>Sliding door handle key hole</i>	R009600001201	R009600001203	R009600001206	R009600001207	R009600001227	R009600001230	24
	13,10	14,30	13,10	14,30	15,10	14,30	
INCASSO PZ Maniglia incasso foro yale <i>Sliding door handle cyl.key hole</i>	R009600005001	R009600005003	R009600005006	R009600005007	R009600005027	R009600005030	24
	13,10	14,30	13,10	14,30	15,10	14,30	

R97



OLV-M1

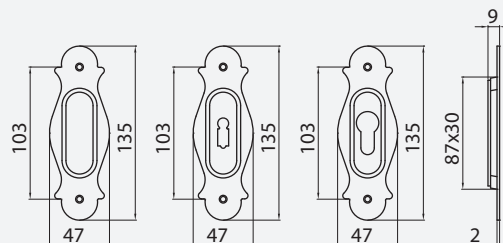

	OLV M1	OF M3	Conf. pz.
INCASSO S/F Maniglia incasso senza foro chiave <i>Sliding door handle</i>	R009700000001	R009700000006	24
	10,50	10,50	
INCASSO BB Maniglia incasso foro BB <i>Sliding door handle key hole</i>	R009800001201	R009800001206	24
	11,10	11,10	
INCASSO PZ Maniglia incasso foro yale <i>Sliding door handle cyl.key hole</i>	R009800005001	R009800005006	24
	11,10	11,10	

SMILE

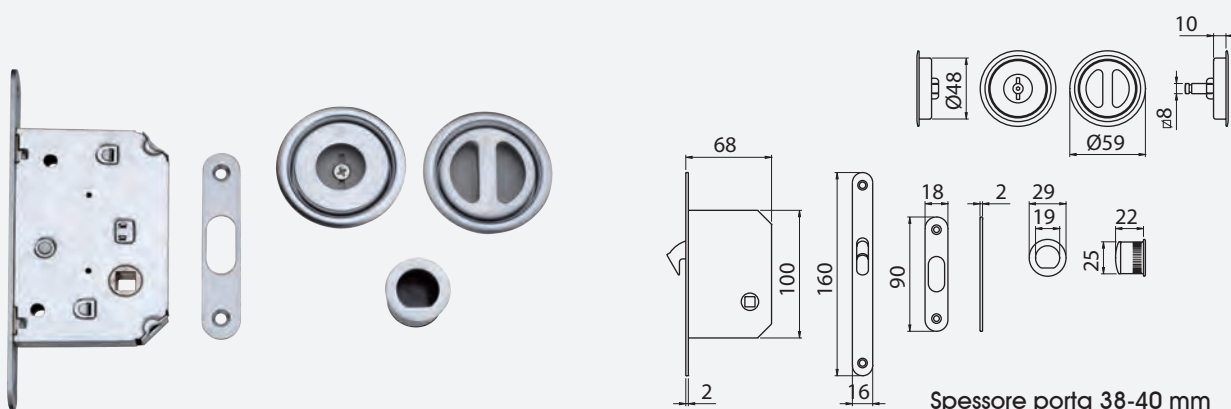

Spessore porta 38-40 mm

OCS-M18

KIT SCORRI SMILE C/S
Kit Scorri - con serratura "B"
 Sliding door kit with lock

OLV M1	OCS M18	OCL M4	Conf. pz.
55748717901	55748717903	55748717907	1
23,10	26,90	26,90	

SCORRI KIT 3 Q



ZCS

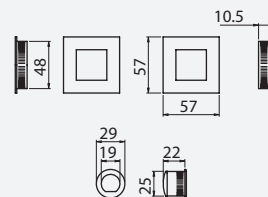

KIT SCORRI QUADRO CIECO

Kit Scorri quadro cieco

Sliding door handle

ZCL	ZCS	Conf. pz.
66148726007	66148726013	12
10,50	10,50	

SCORRI KIT 4 Q



ZCS

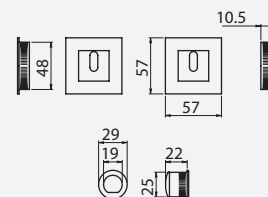

KIT SCORRI QUADRO PAT

Kit Scorri quadro patent

Sliding door handle

ZCL	ZCS	Conf. pz.
66148727007	66148727013	12
10,50	10,50	

SCORRI KIT 4B Q

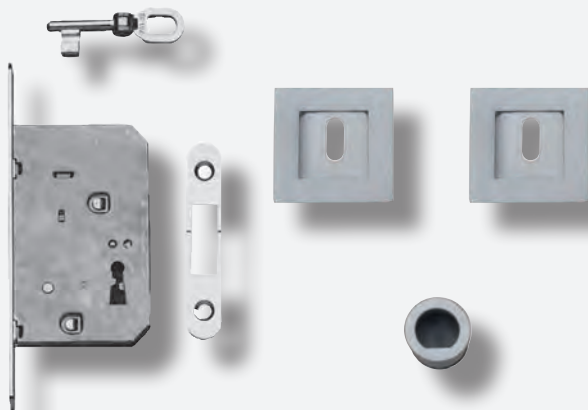

ZCS

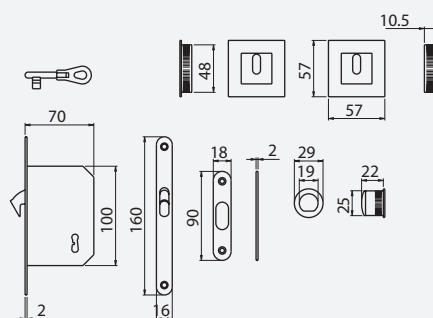

KIT SCORRI QUADRO PAT C/S - B

Kit Scorri - quadro con serratura "B"

Sliding door kit with lock

ZCL	ZCS	Conf. pz.
66148727807	66148727813	1
21,50	21,50	

SCORRI KIT 1B QT

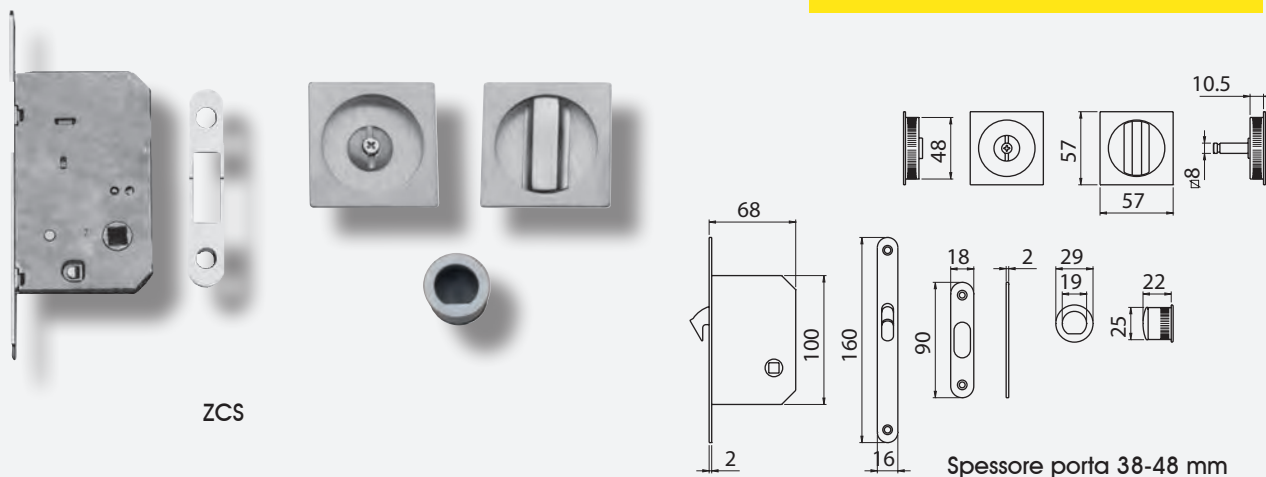

	ZCL	ZCS	Conf. pz.
KIT SCORRI "QT" C/S	66148724807	66148724813	
Kit Scorri - con serratura "B"			1
<i>Sliding door kit with lock</i>	28,40	28,40	

SCORRI KIT 3 QT

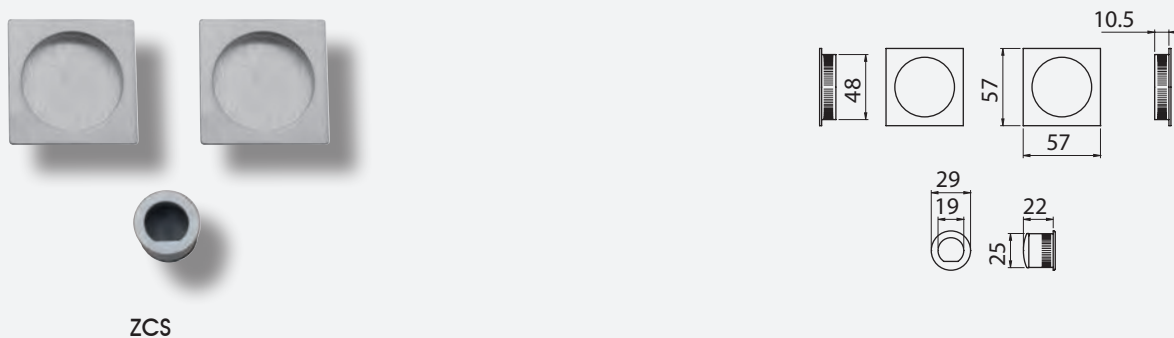

	ZCL	ZCS	Conf. pz.
KIT SCORRI "QT" CIECO	66148724007	66148724013	
Kit Scorri quadro/tondo cieco			12
<i>Sliding door handle</i>	13,10	13,10	

SCORRI KIT 4 QT

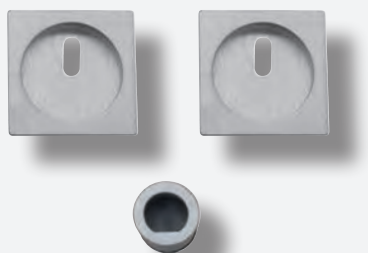

ZCS

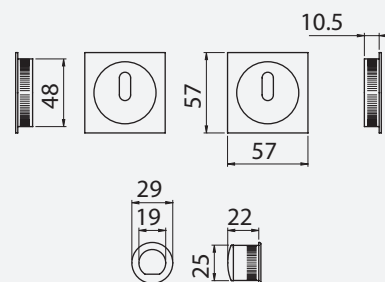

	ZCL	ZCS	Conf. pz.
KIT SCORRI "QT" PAT	66148725007	66148725013	12
Kit Scorri quadro/tondo patent			
<i>Sliding door handle</i>	13,10	13,10	

SCORRI KIT 4B QT

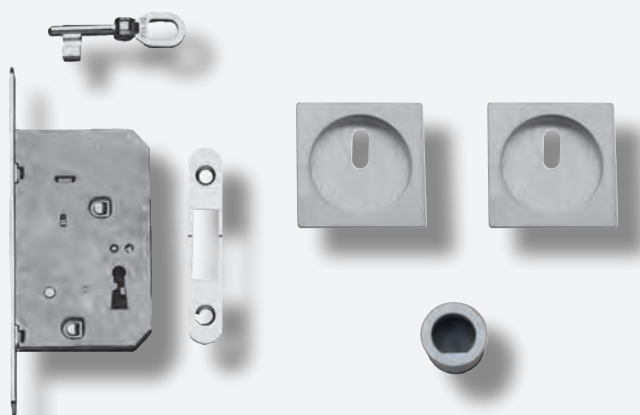

ZCS

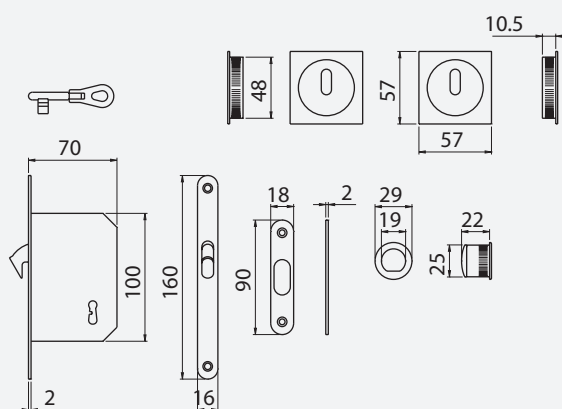

	ZCL	ZCS	Conf. pz.
KIT SCORRI "QT" PAT C/S	66148725807	66148725813	12
Kit Scorri quadro/tondo patent con serratura "B"			
<i>Sliding door handle</i>	26,90	26,90	

SCORRI KIT 1B

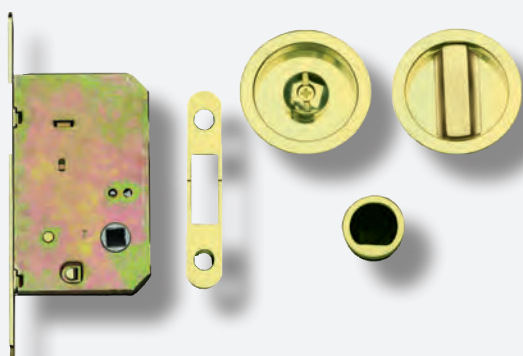

GCTOL

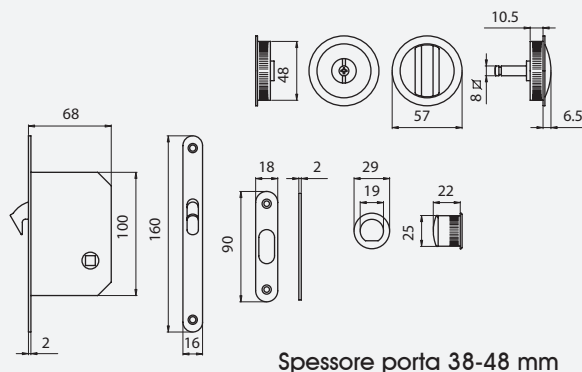

	OBR M45	ZCL	GCTOL	ZCS	Conf. pz.
KIT SCORRI TONDO BLOCC C/S - B Kit Scorri - Blocca tondo con serratura "B" <i>Sliding door kit with lock</i>	55748718800	6GM98718807	6GM98718812	6GM98718813	1
	29,30	23,60	21,00	23,60	

SCORRI KIT 1B PENDENTE

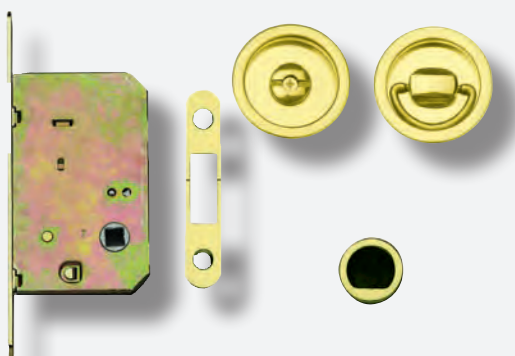

GCTOL

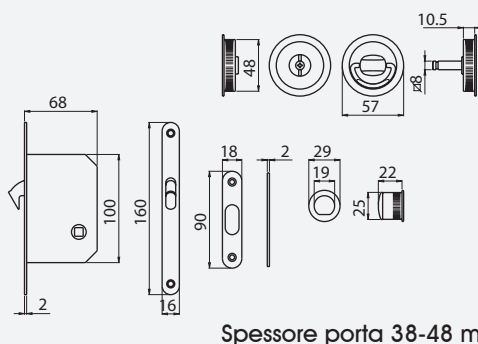

	ZCL	GCTOL	ZCS	Conf. pz.
KIT SCORRI TONDO PEND. BLOCC C/S - B Kit scorri - Blocca tondo pendente con serratura "B" <i>Sliding door kit with lock</i>	66098718907	66098718912	66098718913	1
	29,50	26,30	29,50	

SCORRI KIT 3

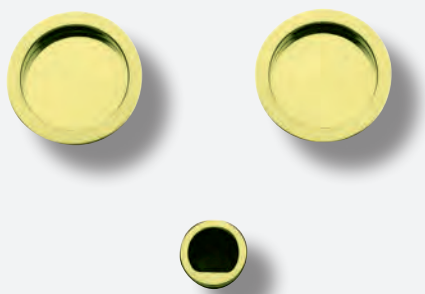

GCTOL

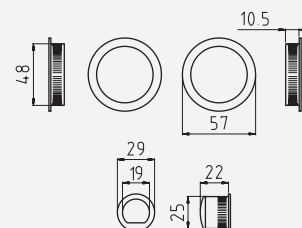

	OBR M45	ZCL	GCTOL	ZCS	Conf. pz.
KIT SCORRI TONDO CIECO	55748716000	6GM98716007	6GM98716012	6GM98716013	12
Kit Scorri tondo cieco <i>Sliding door handle</i>	10,00	9,30	7,10	9,30	

SCORRI KIT 4

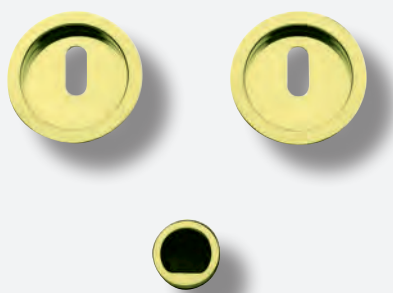

GCTOL

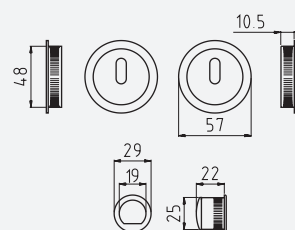

	OBR M45	ZCL	GCTOL	ZCS	Conf. pz.
KIT SCORRI TONDO PAT	55748717000	6GM98717007	6GM98717012	6GM98717013	12
Kit Scorri tondo patent <i>Sliding door handle</i>	10,00	9,30	7,10	9,30	

SCORRI KIT 4B

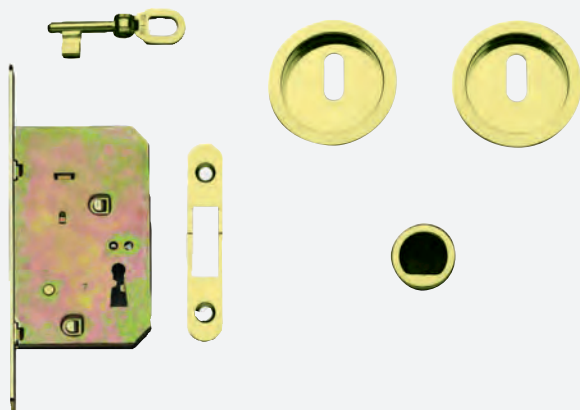

GCTOL

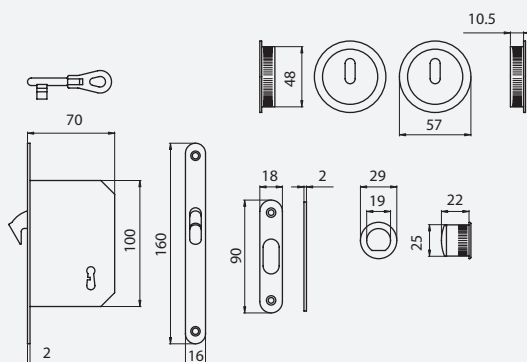

	OBR M45	ZCL	GCTOL	ZCS	Conf. pz.
KIT SCORRI TONDO PAT C/S - B Kit Scorri - tondo con serratura "B" <i>Sliding door kit with lock</i>	55748717800	6GM98717807	6GM98717812	6GM98717813	1
	23,60	19,70	17,20	19,70	

SCORRI KIT 11B

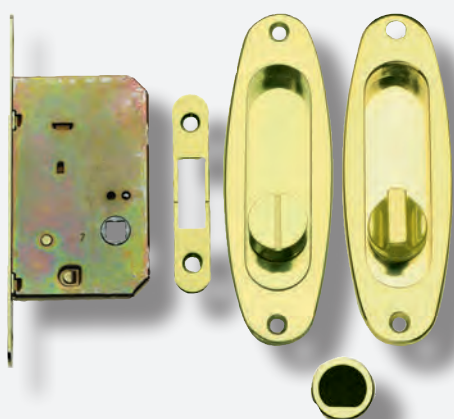

OLV-M1

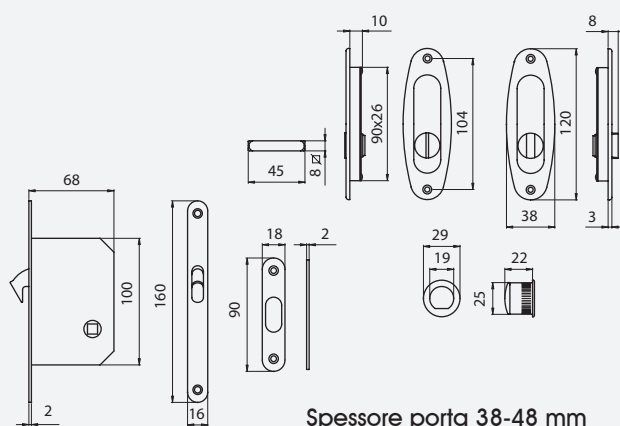

	OBR M45	OLV M1	OCS M18	OCL M4	Conf. pz.
KIT SCORRI OVALE PIC C/S - B Kit Scorri - ovale con serratura "B" <i>Sliding door kit with lock</i>	55498708800	55498708801	55498708803	55498708807	1
	30,60	30,60	35,10	35,10	

SCORRI KIT 12



OLV-M1

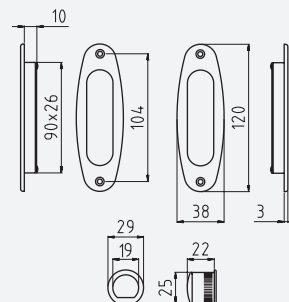

	OBR M45	OLV M1	OCS M18	OCL M4	Conf. pz.
KIT SCORRI OVALE PICC CIECO Kit Scorri - Ovale piccolo cieco <i>Sliding door handle</i>	55498706000	55498706001	55498706003	55498706007	12
	14,70	14,70	17,50	17,50	

SCORRI KIT 13B

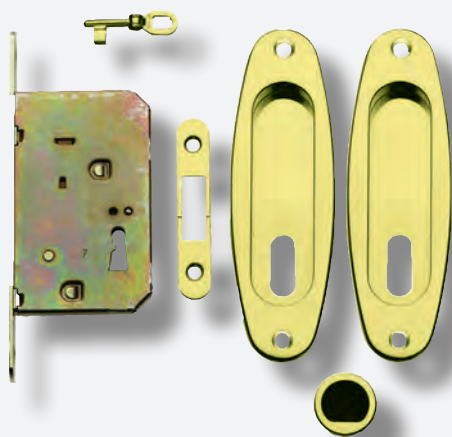

OLV-M1

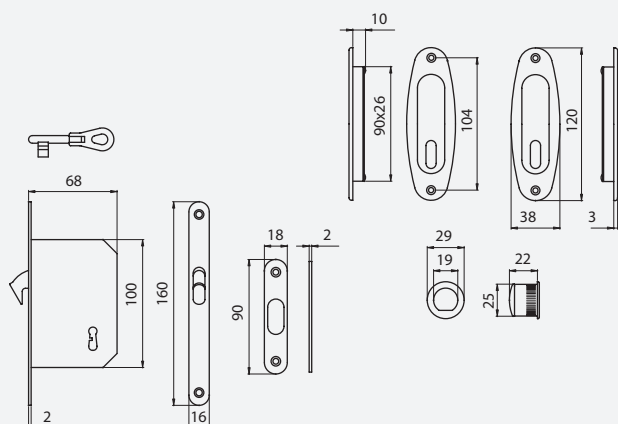

	OBR M45	OLV M1	OCS M18	OCL M4	Conf. pz.
KIT SCORRI OVALE PAT PIC C/S - B Kit Scorri - ovale con serratura "B" <i>Sliding door kit with lock</i>	55498707800	55498707801	55498707803	55498707807	1
	27,50	27,50	31,60	31,60	

SCORRI KIT 1B

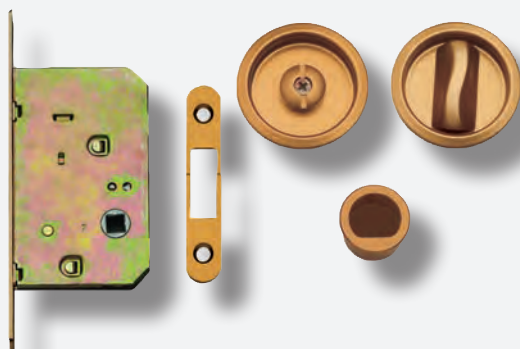

F4

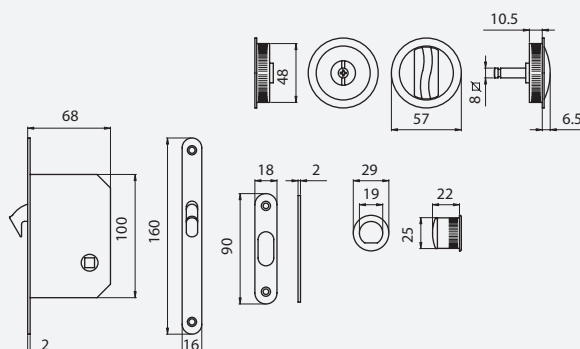

Spessore porta 38-48 mm

	F1	F4	Conf. pz.
KIT SCORRI TONDO BLOCC C/S - B	77048718801	77048718804	
Kit Scorri - Blocca tondo con serratura "B"	25,30	25,30	12
<i>Sliding door kit with lock</i>			

SCORRI KIT 3



F4

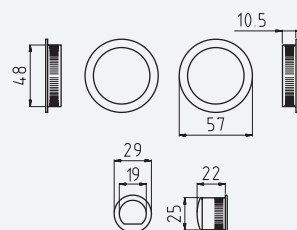

	F1	F4	Conf. pz.
KIT SCORRI TONDO CIECO	77048716001	77048716004	
Kit Scorri tondo cieco	6,60	6,60	12
<i>Sliding door handle</i>			

SCORRI KIT 4

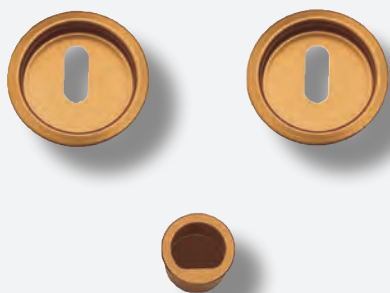

F4

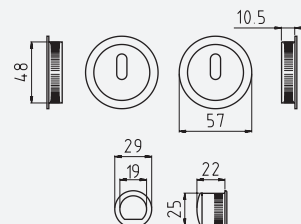

	F1	F4	Conf. pz.
KIT SCORRI TONDO PAT	77048717001	77048717004	
Kit Scorri tondo patent			12
<i>Sliding door kit</i>	6,60	6,60	

SCORRI KIT 4B

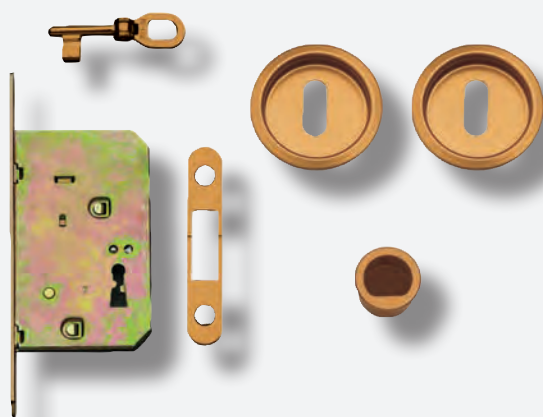

F4

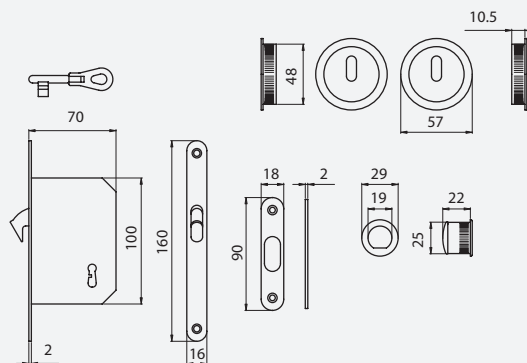

	F1	F4	Conf. pz.
KIT SCORRI TONDO PAT C/S - B	77048717801	77048717804	
Kit Scorri tondo patent con serratura "B"			12
<i>Sliding door kit with lock</i>	20,00	20,00	

TRASCINATORE



OLV-M1

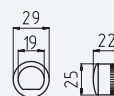

	OBR M45	OLV M1	OCS M18	OCL M4	Conf. pz.
TRASCINATORE PORTE SCORR	55748710000	55748710001	55748710003	55748710007	
Trascinatore per porte scorrevoli	3,20	3,20	3,70	3,70	24
<i>Round handle for sliding door</i>					

TRASCINATORE



F4

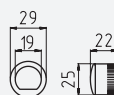

	F1	F4	Conf. pz.
TRASCINATORE PORTE SCORR	77048710001	77048710004	
Trascinatore per porte scorrevoli	2,70	2,70	24
<i>Sliding door handle</i>			

GABRY



F4

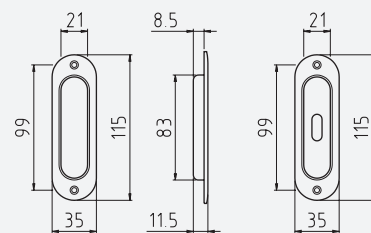

	F1	F4	Conf. pz.
INCAS S/F Maniglia incasso senza foro chiave <i>Sliding door handle</i>	77498700001	77498700004	24
	2,90	2,90	
INCAS PAT Maniglia incasso foro patent <i>Sliding door handle key hole</i>	77498701001	77498701004	24
	2,90	2,90	

6009



F4

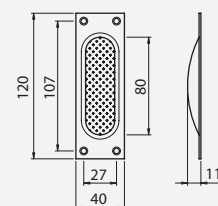

	F1	F4	Conf. pz.
INCAS S/F Maniglia incasso senza foro chiave <i>Sliding door handle</i>	76009700001	76009700004	24
	1,65	1,65	

SCORRI TONDO



F4

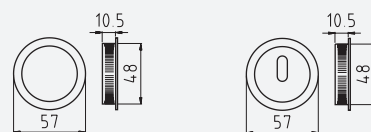

	F1	F4	Conf. pz.
SCORRI TONDA MM 48 CIECA Incasso tonda d.48 cieca <i>Sliding door handle</i>	77048748001	77048748004	24
	2,10	2,10	
SCORRI TONDA MM 48 PAT Incasso tonda d.48 con foro patent spostato <i>Sliding door handle</i>	77048746001	77048746004	24
	2,10	2,10	



MANIGLIONI *PULL HANDLES*

■ AIRONE	464
■ ARIANNA DIRITTO	468
■ ARIANNA ZANCATO	469
■ ARIETE	459
■ COMETA	465
■ DOMINO	454
■ EUCLIDE	451
■ EUROPA	473
■ FRAME	450
■ GINEVRA DIRITTO	457
■ GINEVRA ZANCATO	458
■ GIOTTO	455
■ IMPERO	466
■ MANIGLIETTA PONTE	472
■ MARY	470
■ MARY MIGNON	471
■ MARZIA DIRITTO	460
■ MARZIA TONDO	461
■ MILENA ZANCATO DIRITTO	462
■ MILENA TONDO	463
■ SOGNO	456
■ SPAGNA	467
■ YORK-Z DIRITTO	452
■ YORK-Z ZANCATO	453

FRAME

Design: Fabrizio Bianchetti



F1-SAT/GCTCL

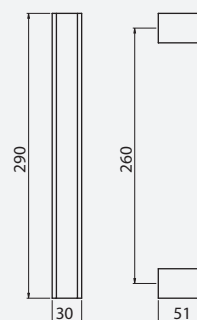

	F1-SAT	F1-SAT/GCTCL	F1-SAT/F9 SAT	Conf. pz.
MAN DIR Maniglione diritto <i>Staight pull handle</i>	77472600233	7747260023324	7747260023334	2
	37,10	37,60	42,60	
MAN DIR VET Coppia maniglioni diritti per vetro <i>Staight pull handle for glass</i>	77472606033	7747260603324	7747260603334	1
	72,30	73,30	83,20	
MAN DIR L/A Coppia maniglioni diritti per legno/alluminio <i>Staight pull handle for alu/wood</i>	77472607033	7747260703324	7747260703334	1
	72,30	73,30	83,20	

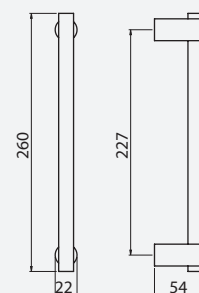

OCL-M4/F1-SAT

	OCL-M4/F1-SAT	Conf. pz.
MAN DIR Maniglione diritto <i>Straight pull handle</i>	77056600254 25,50	2
MAN DIR VET Coppia maniglioni diritti per vetro <i>Straight pull handle for glass</i>	77056606054 50,60	1
MAN DIR L/A Coppia maniglioni diritti per legno/alluminio <i>Straight pull handle for alu/wood</i>	77056607054 50,60	1

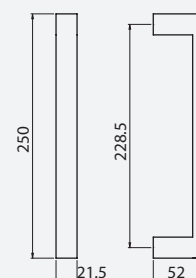

ZCS

	ZCL	ZCS	Conf. pz.
MAN DIR Maniglione diritto <i>Straight pull handle</i>	66460600207 31,50	66460600213 31,50	2
MAN DIR VET Coppia maniglioni diritti per vetro <i>Straight pull handle for glass</i>	66460606007 61,40	66460606013 61,40	1
MAN DIR L/A Coppia maniglioni diritti per legno/alluminio <i>Straight pull handle for alu/wood</i>	66460607007 61,40	66460607013 61,40	1

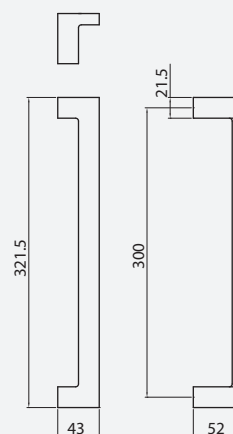

ZCS

	ZCL	ZCS	Conf. pz.
MAN ZAN Maniglione zancato <i>Offset pull handle</i>	66460610207 56,70	66460610213 44,50	2
MAN ZAN VET Coppia maniglioni zancati per vetro <i>Pair of offset pull handle for glass</i>	66460616007 111,10	66460616013 77,10	1
MAN ZAN L/A Coppia maniglioni zancati per legno/alluminio <i>Pair of offset pull handle for alu/wood</i>	66460617007 111,10	66460617013 77,10	1

DISPONIBILE FINO AD ESAURIMENTO SCORTE

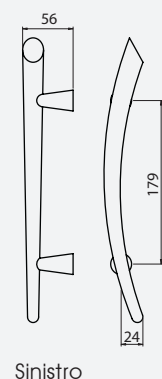
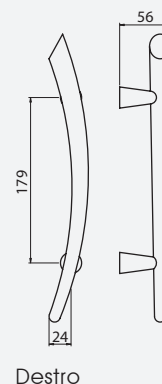

OCS-M18

	OLV M1	OCS M18	OCL M4	G-PLUS M36	Conf. pz.
MAN ZAN DX Maniglione zancato destro <i>Straight pull handle</i>	55740610001	55740610003	55740610007	55740610050	1
	51,80	53,60	53,60	71,90	
MAN ZAN SX Maniglione zancato sinistro <i>Straight pull handle</i>	55740613001	55740613003	55740613007	55740613050	1
	51,80	53,60	53,60	71,90	
MAN ZAN VET Coppia maniglioni zancati per vetro <i>Pair of pull handle for glass</i>	55740616001	55740616003	55740616007	55740616050	1
	103,50	107,00	107,00	143,70	
MAN ZAN L/A Coppia maniglioni zancati per legno/alluminio <i>Pair of pull handle for alu/wood</i>	55740617001	55740617003	55740617007	55740617050	1
	103,50	107,00	107,00	143,70	

DISPONIBILE FINO AD ESAURIMENTO SCORTE

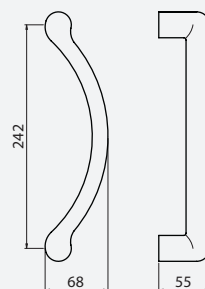

OCS-M18

	OLV M1	OCS M18	OCL M4	G-PLUS M36	Conf. pz.
MAN ZAN Maniglione zancato <i>Straight pull handle</i>	55016610001	55016610003	55016610007	55016610050	1
	69,30	70,90	70,90	80,20	
MAN ZAN VET Coppia maniglioni zancati per vetro <i>Pair of pull handle for glass</i>	55016616001	55016616003	55016616007	55016616050	1
	113,70	117,00	117,00	160,30	
MAN ZAN L/A Coppia maniglioni zancati per legno/alluminio <i>Pair of pull handle for alu/wood</i>	55016617001	55016617003	55016617007	55016617050	1
	113,70	117,00	117,00	160,30	



ZCS

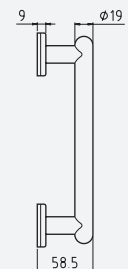
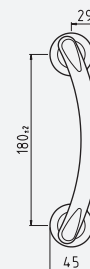
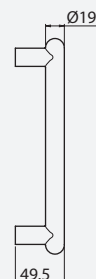

	ZCL	GCTOL	ZCS	ZNO	ZNS	G-PLUS M36	Conf. pz.
MAN ZAN S/R	66096610107	66096610112	66096610113	66096610116	66096610127	66096610150	
Maniglione zancato senza rosetta							2
<i>Staight pull handle without roses</i>	21,70	21,70	21,70	21,70	23,80	52,50	
MAN ZAN VET S/R	66096616107	66096616112	66096616113	66096616116	66096616127	66096616150	
Coppia maniglioni zancati per vetro senza rosetta							1
<i>Staight pull handle for glass without roses</i>	43,40	43,40	43,40	43,40	47,60	105,00	
MAN ZAN L/A S/R	66096617107	66096617112	66096617113	66096617116	66096617127	66096617150	
Coppia maniglioni zancati per legno/all senza rosetta							1
<i>Staight pull handle for alu/wood without roses</i>	43,40	43,40	43,40	43,40	47,60	105,00	
	ZCL	GCTOL	ZCS	ZNO	ZNS	G-PLUS M36	Conf. pz.
MAN ZAN R	66096612007	66096612012	66096612013	66096612016	66096612027	66096612050	
Maniglione zancato su rosetta							2
<i>Offset pull handle</i>	44,40	35,20	46,20	35,20	47,00	69,50	



INOX

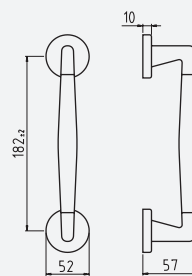
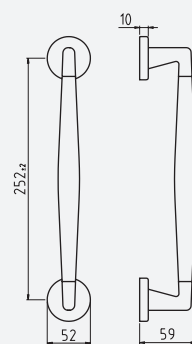

	INOX	INOX/G-PLUS	Conf. pz.
MAN DIR R MM 252 Manigione diritto su rosetta mm. 252 <i>Straight pull handle on rose</i>	55846602055 68,40	55846602056 79,00	1
MAN DIR R MM 182 Manigione diritto su rosetta mm. 182 <i>Straight pull handle on rose</i>	55846604055 59,80	55846604056 70,40	1

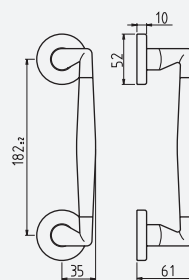
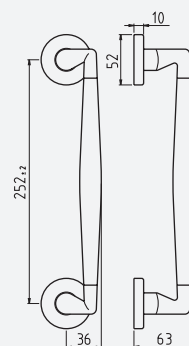

INOX

	INOX	INOX/G-PLUS	Conf. pz.
MAN ZAN R MM 252 Maniglione zancato su rosetta mm. 252 <i>Offset pull handle on rose</i>	55846612055 68,40	55846612056 79,00	1
MAN ZAN R MM 182 Maniglione zancato su rosetta mm. 182 <i>Offset pull handle on rose</i>	55846614055 59,80	55846614056 70,40	1

DISPONIBILE FINO AD ESAURIMENTO SCORTE



OLV-M1

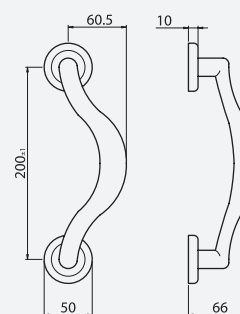
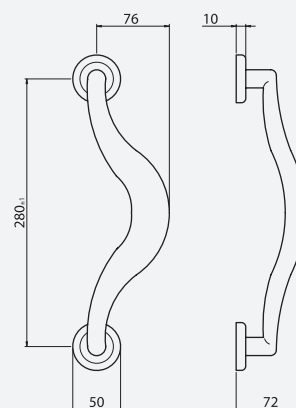

	OLV M1	OCS M18	OCL M4	G-PLUS M36	Conf. pz.
MAN MM. 280 R	55696612001	55696612003	55696612007	55696612050	1
Maniglione mm. 280 con rosetta <i>Pull handle 280 on rose</i>	59,80	72,10	72,10	115,00	
MAN MM. 200 R	55696614001	55696614003	55696614007	55696614050	1
Maniglione mm. 200 con rosetta <i>Pull handle 200 on rose</i>	53,60	65,90	65,90	108,80	



OLV-M1

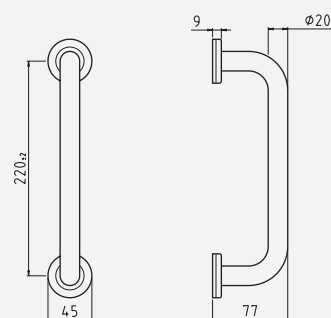

	OLV M1	OCS M18	OGV M27	OCL M4	OS M2	G-PLUS M36	Conf. pz.
MAN DIR R Maniglione diritto su rosetta <i>Straight pull handle on rose</i>	55424602001 61,50	55424602003 69,70	55424602004 61,50	55424602007 69,70	55424602008 61,50	55424602050 126,40	2
MAN DIR VET Coppia maniglioni dritti per vetro <i>Pair pull handle for glass</i>	55424606001 123,00	55424606003 139,40	55424606004 123,00	55424606007 139,40	55424606008 123,00	55424606050 252,80	1
MAN DIR L/A Coppia maniglioni dritti per legno/alluminio <i>Pair pull handle for alu/wood</i>	55424607001 123,00	55424607003 139,40	55424607004 123,00	55424607007 139,40	55424607008 123,00	55424607050 252,80	1

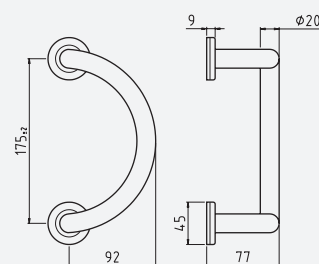

OLV-M1

	OLV M1	OCS M18	OGV M27	OCL M4	OS M2	G-PLUS M36	Conf. pz.
MAN TON R Maniglione tondo su rosetta <i>Straight pull handle on rose</i>	55424652001 61,50	55424652003 69,70	55424652004 61,50	55424652007 69,70	55424652008 61,50	55424652050 126,40	2
MAN TON VET Coppia maniglioni tondi per vetro <i>Pair of straight pull handle for glass</i>	55424656001 123,00	55424656003 139,40	55424656004 123,00	55424656007 139,40	55424656008 123,00	55424656050 252,80	1
MAN TON L/A Coppia maniglioni tondi per legno/alluminio <i>Pair of straight pull handle for alu/wood</i>	55424657001 123,00	55424657003 139,40	55424657004 123,00	55424657007 139,40	55424657008 123,00	55424657050 252,80	1



OLV-M1

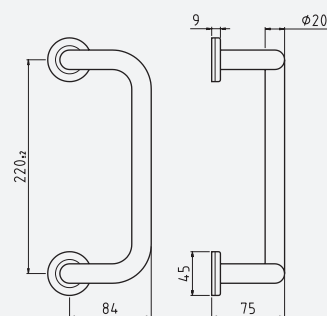

	OLV M1	OCS M18	OGV M27	OCL M4	OS M2	G-PLUS M36	Conf. pz.
MAN ZANDR R Maniglione zancato diritto <i>Pull handle on rose</i>	55744612001 76,50	55744612003 88,80	55744612004 76,50	55744612007 88,80	55744612008 76,50	55744612050 136,70	1
MAN ZANDR VET Coppia maniglioni zanc. dir. per vetro <i>Pair of pull handle for glass</i>	55744616001 153,10	55744616003 177,70	55744616004 153,10	55744616007 177,70	55744616008 153,10	55744616050 273,30	1
MAN ZANDR L/A Coppia maniglioni zanc. dir. per legno/alluminio <i>Pair of pull handle for alu/wood</i>	55744617001 153,10	55744617003 177,70	55744617004 153,10	55744617007 177,70	55744617008 153,10	55744617050 273,30	1

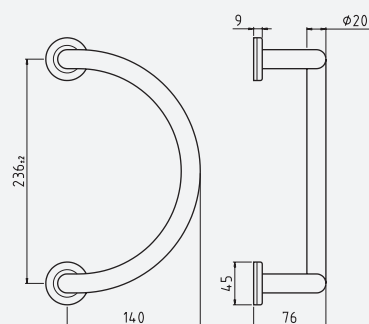

OLV-M1

	OLV M1	OCS M18	OGV M27	OCL M4	OS M2	G-PLUS M36	Conf. pz.
MAN ZANTO R	55744662001	55744662003	55744662004	55744662007	55744662008	55744662050	
Maniglione zancato tondo su rosetta <i>Offset pull handle on rose</i>	76,50	88,80	76,50	88,80	76,50	136,70	1
MAN ZANTO VET	55744666001	55744666003	55744666004	55744666007	55744666008	55744666050	
Coppia maniglioni zanc. ton. per vetro <i>Pair of pull handle for glass</i>	153,10	177,70	153,10	177,70	153,10	273,30	1
MAN ZANTO L/A	55744667001	55744667003	55744667004	55744667007	55744667008	55744667050	
Coppia maniglioni zanc. ton. per legno/alluminio <i>Pair of pull handle for alu/wood</i>	153,10	177,70	153,10	177,70	153,10	273,30	1

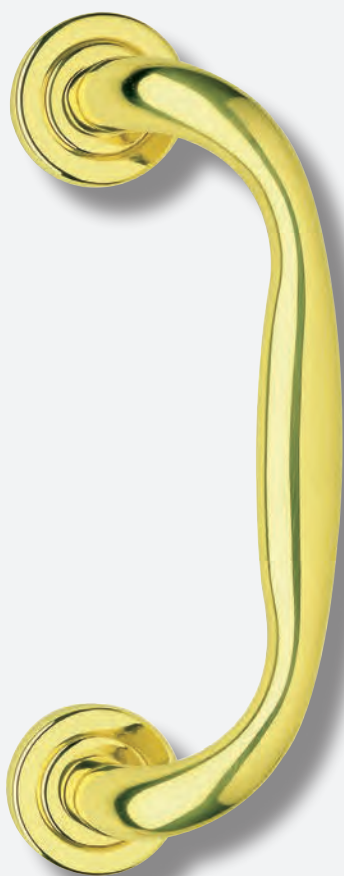

OLV-M1

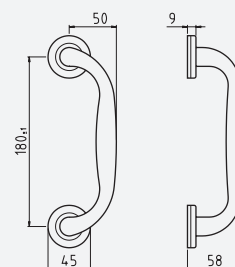

	OLV M1	OCS M18	OCL M4	ONS M9	G-PLUS M36	Conf. pz.
MAN ZAN R	55040612001	55040612003	55040612007	55040612027	55040612050	
Maniglione zancato su rosetta						2
<i>Offset pull handle</i>	35,50	39,60	39,60	42,40	68,40	



OLV-M1

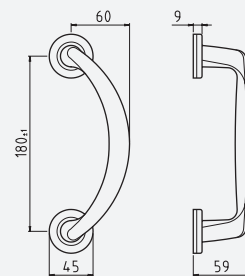

	OLV M1	OCS M18	OCL M4	ONS M9	G-PLUS M36	Conf. pz.
MAN ZAN R	55034612001	55034612003	55034612007	55034612027	55034612050	
Maniglione zancato su rosetta	35,50	39,60	39,60	42,40	68,40	2
<i>Offset pull handle</i>						

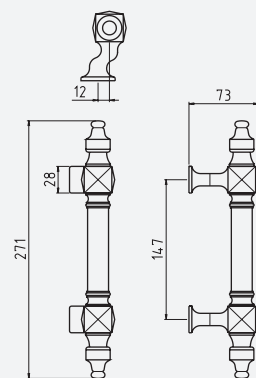

OLV-M1

	OLV M1	OGV M27	OF M3	OLD MV3	G-PLUS M36	Conf. pz.
MAN ZANC	55418612001	55418612004	55418612006	55418612028	55418612050	2
Maniglione zancato	62,90	62,90	62,90	62,90	90,00	
<i>Offset pull handle</i>						

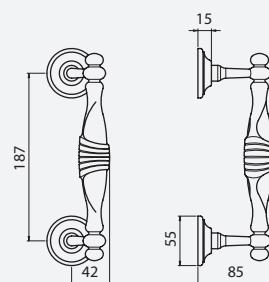

OLV-M1

	OLV M1	OGV M27	G-PLUS M36	Conf. pz.
MAN ZAN R	55096612001	55096612004	55096612050	
Maniglione zancato su rosetta				2
<i>Offset pull handle on rose</i>	143,30	143,30	209,70	



OLV-M1



OFA-M69

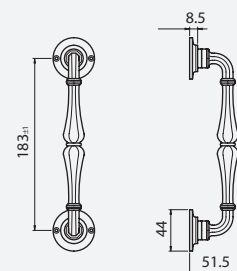
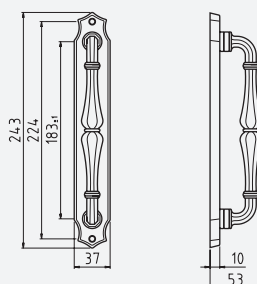
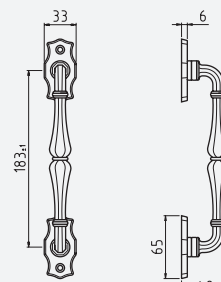

	OLV M1	OGV M27	OF M3	OLD MV3	OFA M69	Conf. pz.
MAN DIR P	55640601001	55640601004	55640601006	55640601028	55640601029	
Maniglione diritto su placca						2
<i>Straight pull handle on plate</i>	38,60	38,60	38,60	38,60	50,20	
MAN DIR R	55640602001	55640602004	55640602006	55640602028	55640602029	
Maniglione diritto su rosetta						2
<i>Straight pull handle on rose</i>	38,60	38,60	38,60	38,60	50,20	
MAN DIR RTVV	55640602301	55640602304	55640602306	55640602328	55640602329	
Maniglione diritto su rosetta tonda visti in vista						2
<i>Straight pull handle on rose</i>	38,60	38,60	38,60	38,60	50,20	



OLV-M1



OFA-M69

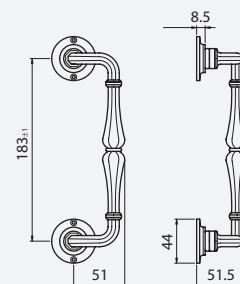
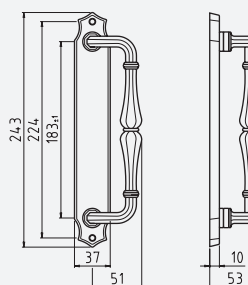
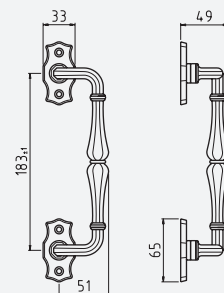

	OLV M1	OGV M27	OF M3	OLD MV3	OFA M69	Conf. pz.
MAN ZAN P	55640611001	55640611004	55640611006	55640611028	55640611029	
Maniglione zancato su placca <i>Offset pull handle on plate</i>	40,30	40,30	40,30	40,30	51,90	2
MAN ZAN R	55640612001	55640612004	55640612006	55640612028	55640612029	
Maniglione zancato su rosetta <i>Offset pull handle on rose</i>	40,30	40,30	40,30	40,30	51,90	2
MAN ZAN RTVV	55640612301	55640612304	55640612306	55640612328	55640612329	
Maniglione zancato su rosetta tonda visti in vista <i>Offset pull handle on rose</i>	40,30	40,30	40,30	40,30	51,90	2



OLV-M1

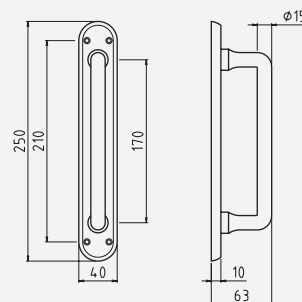
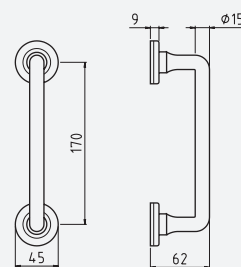

	OLV M1	OCS M18	OGV M27	Conf. pz.
MAN DIR P Maniglione diritto su placca <i>Straight pull handle on plate</i>	55422601001 38,60	n.d.	55422601004 38,60	2
MAN DIR R Maniglione diritto su rosetta <i>Straight pull handle on rose</i>	55422602001 40,00	55422602003 48,60	55422602004 40,00	2

MARY MIGNON

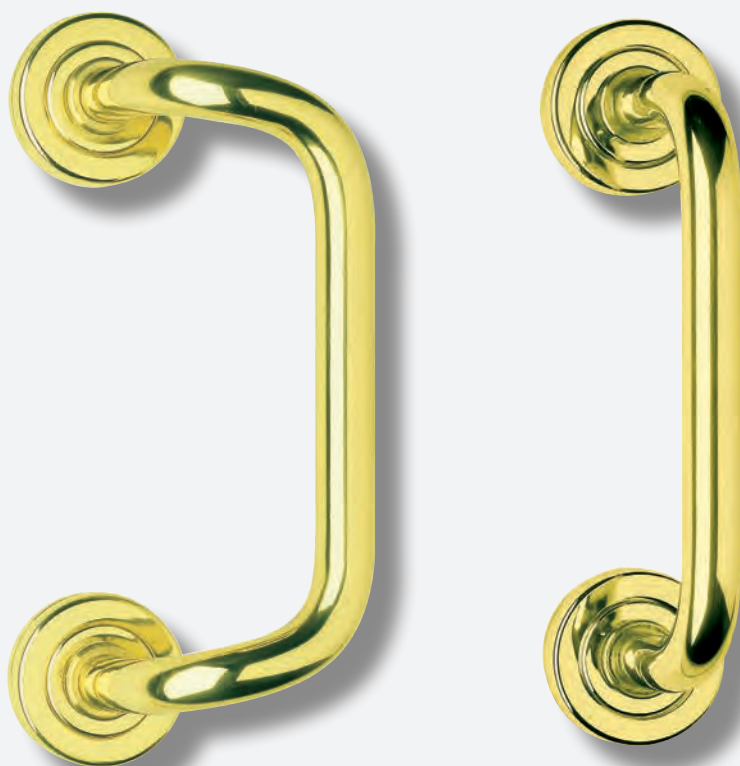

OLV-M1

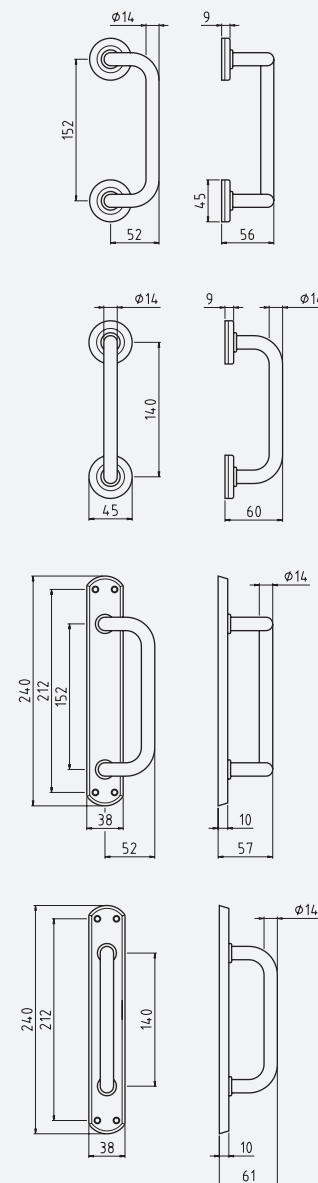

	OLV M1	OCS M18	OGV M27	Conf. pz.
MIGN MAN DIR P Maniglione mignon diritto su placca <i>Pull handle straight on plate</i>	55422605001	n.d.	55422605004	6
	33,90		33,90	
MIGN MAN DIR R Maniglione mignon diritto su rosetta <i>Pull handle straight on roses</i>	55422604001	55422604003	55422604004	6
	33,90	41,70	33,90	
MIGN MAN ZAN P Maniglione mignon zancato su placca <i>Pull handle offset on plate</i>	55422615001	n.d.	55422615004	6
	40,00		40,00	
MIGN MAN ZAN R Maniglione mignon zancato su rosetta <i>Pull handle offset on roses</i>	55422614001	55422614003	55422614004	6
	40,00	49,40	40,00	

MANIGLIETTA PONTE

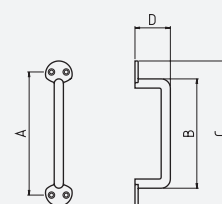
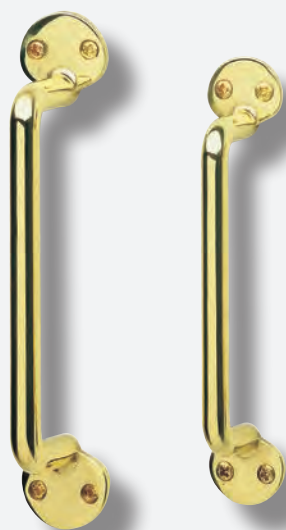

Interasse	A (mm)	B (mm)	C (mm)	D (mm)
mm 100	100	84	123	35
mm 120	120	104	143	35
mm 140	134	119	158	35
mm 160	160	140	188	40

OLV-M1

	OLV M1	OGV M27	Conf. pz.
MAN PONTE MM 100 Maniglie a ponte mm 100 <i>Pull handle mm.100</i>	49236100001	49236100004	24
	7,90	7,90	
MAN PONTE MM 120 Maniglie a ponte mm 120 <i>Pull handle mm.120</i>	49236120001	49236120004	24
	8,60	8,60	
MAN PONTE MM 140 Maniglie a ponte mm 140 <i>Pull handle mm.140</i>	49236140001	49236140004	24
	9,20	9,20	
MAN PONTE MM 160 Maniglie a ponte mm 160 <i>Pull handle mm.160</i>	49236160001	49236160004	12
	9,90	9,90	



F4

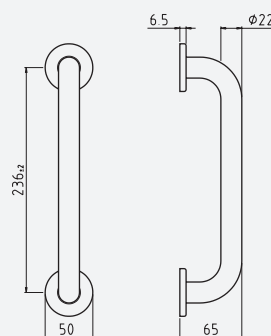

	F1	F4	Conf. pz.
MAN DIR R	77446602001	77446602004	
Maniglione diritto su rosetta	26,50	26,50	2
<i>Straight pull handle on rose</i>			



MANIGLIONI ALZANTI *SLIDING DOORS PULL HANDLES PULL HANDLES*

■ YORK-Z	476
■ EUCLIDE	477
■ EUROPA	482
■ GM	481
■ MILENA	480
■ RAPSODY	479
■ SHARK	478



ZCS

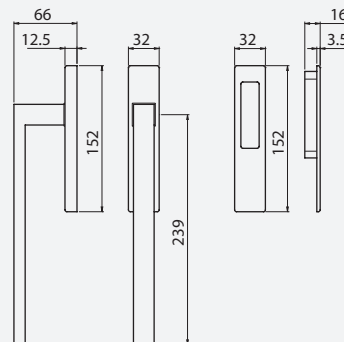

	ZCL	ZCS	Conf. pz.
SCATTO MAN PC CONCH. Maniglione a scatto placca chiusa con conchiglia <i>Pull handle for sliding door-closed plate</i>	66460601007	66460601013	1
	61,40	61,40	
SCATTO MAN PC PY Maniglione a scatto placca yale <i>Pull handle for sliding door w/ cyl. hole</i>	66460601507	66460601513	1
	49,40	49,40	
SCATTO MANCP Q 10 PC Coppia maniglioni a scatto Q10 placca chiusa <i>Pair of pull handle Q10</i>	66460620007	66460620013	1
	96,10	96,10	
SCATTO MANCP Q 10 PY Coppia maniglioni a scatto Q10 placca yale <i>Pair of pull handle Q10 w/ cyl. Hole</i>	66460620507	66460620513	1
	96,10	96,10	
CONCH MAN SCATTO Conchiglia per maniglione a scatto <i>Sliding handle</i>	66460680907	66460680913	4
	9,50	9,50	



OCL-M4/F1-SAT

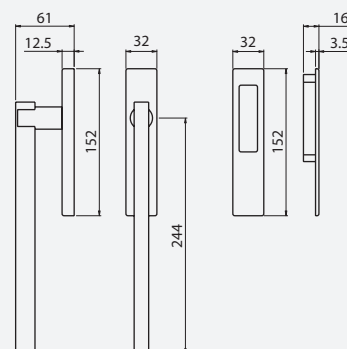

	OCL-M4 F1-SAT	Conf. pz.
SCATTO MAN PC CONCH. Maniglione a scatto placca chiusa con conchiglia <i>Pull handle for sliding door-closed plate -</i>	77056601054 54,40	1
SCATTO MAN PC PY Maniglione a scatto placca yale <i>Pull handle for sliding door w/cyl. hole</i>	77056601554 48,50	1
SCATTO MANCP Q 10 PC Coppia maniglioni a scatto Q10 placca chiusa <i>Pair of pull handle Q10</i>	77056620054 97,00	1
SCATTO MANCP Q 10 PY Coppia maniglioni a scatto Q10 placca yale <i>Pair of pull handle Q10 w/ cyl. hole</i>	77056620554 97,00	1
CONCH MAN SCATT Conchiglia per maniglione a scatto <i>Sliding handle</i>	77056680954 6,70	4



OCS-M18

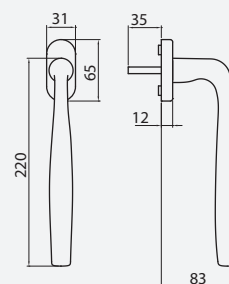
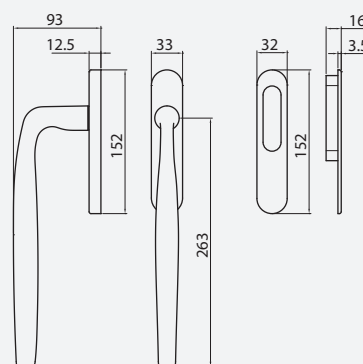

	OLV M1	OCS M18	OCL M4	Conf. pz.
SCATTO MAN PC CONCH. Maniglione a scatto placca chiusa con conchiglia <i>Pull handle for sliding door-closed plate</i>	55480601001 98,20	55480601003 102,90	55480601007 102,90	1
SCATTO MAN PC PY Maniglione a scatto placca yale <i>Pull handle for sliding door w/ cyl. hole</i>	55480601501 88,70	55480601503 92,70	55480601507 92,70	1
SCATTO MANCP Q 10 PC Coppia maniglioni a scatto Q10 placca chiusa <i>Pair of pull handle Q10</i>	55480620001 168,00	55480620003 176,70	55480620007 176,70	1
SCATTO MANCP Q 10 PY Coppia maniglioni a scatto Q10 placca yale <i>Pair of pull handle Q10 w/ cyl. Hole</i>	55480620501 168,00	55480620503 176,70	55480620507 176,70	1
CONCH MAN SCATTO Conchiglia per maniglione a scatto <i>Sliding handle</i>	55980680901 9,30	55980680903 10,70	55980680907 10,70	4
SCATTO MI MAN ROS OV G/FERRO Maniglione a scatto mignon rosetta ovale <i>Small pull handle for sliding door on oval rose</i>	55480605201 67,70	55480605203 71,40	55480605207 71,40	1



OCS-M18

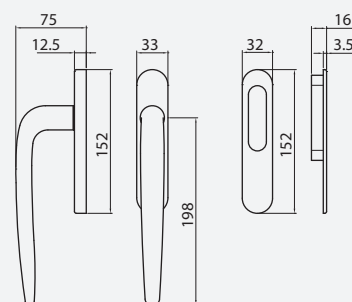
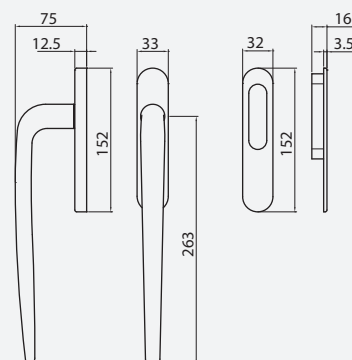

	OLV M1	OCS M18	OCL M4	Conf. pz.
SCATTO MAN PC CONCH. Maniglione a scatto placca chiusa con conchiglia <i>Pull handle for sliding door-closed plate -</i>	55470601001	55470601003	55470601007	1
	71,90	75,00	75,00	
SCATTO MAN PC PY Maniglione a scatto placca yale <i>Pull handle for sliding door w/cyl. hole</i>	55470601501	55470601503	55470601507	1
	64,60	67,30	67,30	
SCATTO MANCP Q 10 PC Coppia maniglioni a scatto Q10 placca chiusa <i>Pair of pull handle Q10</i>	55470620001	55470620003	55470620007	1
	120,45	126,70	126,70	
SCATTO MANCP Q 10 PY Coppia maniglioni a scatto Q10 placca yale <i>Pair of pull handle Q10 w/ cyl. hole</i>	55470620501	55470620503	55470620507	1
	120,45	126,70	126,70	
SCATTO MI MAN PC CONCH. Maniglione a scatto mignon placca chiusa con conchiglia <i>Small pull handle for sliding door . Closed pl.</i>	55470605001	55470605003	55470605007	2
	69,20	72,10	72,10	
SCATTO MI MAN PC PY Maniglione a scatto mignon placca yale <i>Small pull handle for sliding door . W /cyl. plate</i>	55470605501	55470605503	55470605507	2
	61,75	64,50	64,50	
CONCH MAN SCATT Conchiglia per maniglione a scatto <i>Sliding handle</i>	55980680901	55980680903	55980680907	4
	9,30	10,70	10,70	



OLV-M1

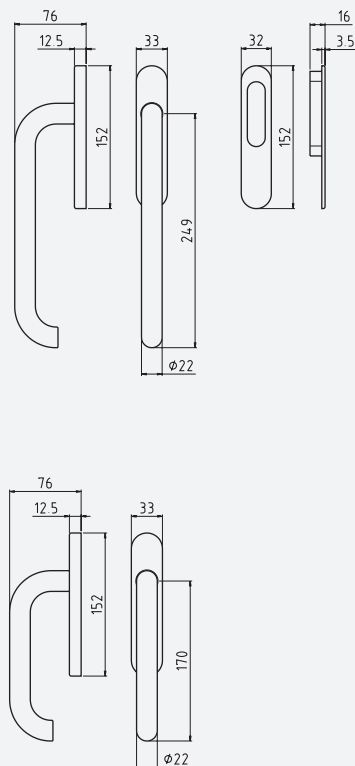

	OLV M1	OCS M18	OGV M27	OCL M4	OS M2	G-PLUS M36	Conf. Pz.
SCATTO MAN PC CONCH. Maniglione a scatto placca chiusa con conchiglia <i>Pull handle for sliding door-closed plate -</i>	55980601001	55980601003	55980601004	55980601007	55980601008	55980601050	1
	90,90	92,20	90,90	92,20	90,90	143,90	
SCATTO MAN PC PY Maniglione a scatto placca yale <i>Pull handle for sliding door w/cyl. hole</i>	55980601501	55980601503	55980601504	55980601507	55980601508	55980601550	1
	82,80	84,30	82,80	84,30	82,80	122,60	
SCATTO MANCP Q 10 PC Coppia maniglioni a scatto Q10 placca chiusa <i>Pair of pull handle Q10</i>	55980620001	55980620003	55980620004	55980620007	55980620008	55980620050	1
	163,00	165,90	163,00	165,90	163,00	245,50	
SCATTO MANCP Q 10 PY Coppia maniglioni a scatto Q10 placca yale <i>Pair of pull handle Q10 w/ cyl. hole</i>	55980620501	55980620503	55980620504	55980620507	55980620508	55980620550	1
	163,00	165,90	163,00	165,90	163,00	245,50	
SCATTO MI MAN PC CONCH. Maniglione a scatto mignon placca chiusa con conchiglia <i>Small pull handle for sliding door . Closed pl.</i>	55980605001	55980605003	55980605004	55980605007	55980605008	n.d.	2
	95,60	96,80	95,60	96,80	95,60		
SCATTO MI MAN PC PY Maniglione a scatto mignon placca yale <i>Small pull handle for sliding door . W /cyl. plate</i>	55980605501	55980605503	55980605504	55980605507	55980605508	n.d.	2
	87,20	88,60	87,20	88,60	87,20		
CONCH MAN SCATT Conchiglia per maniglione a scatto <i>Sliding handle</i>	55980680901	55980680903	55980680904	55980680907	55980680908	55980680950	4
	9,30	10,70	9,30	10,70	9,30	21,10	



OLV-M1

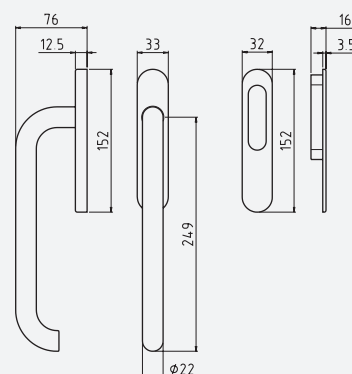

	OLV M1	OCS M18	OGV M27	OCL M4	OS M2	OBO M45	Conf. pz.
SCATTO GM MAN PC CONCH. Maniglione a scatto placca chiusa con conchiglia <i>Pull handle for sliding door-closed plate -</i>	5GM96601001	5GM96601003	5GM96601004	5GM96601007	5GM96601008	5GM96601010	1
	54,70	71,10	60,20	71,10	60,20	60,20	
SCATTO GM MAN PC PY Maniglione a scatto placca yale <i>Pull handle for sliding door w/cyl. hole</i>	5GM96601501	5GM96601503	5GM96601504	5GM96601507	5GM96601508	5GM96601510	1
	50,00	65,00	55,10	65,00	55,10	55,10	
SCATTO GM MANCP Q 10 PC Coppia maniglioni a scatto Q10 placca chiusa <i>Pair of pull handle Q10</i>	5GM96620001	5GM96620003	5GM96620004	5GM96620007	5GM96620008	5GM96620010	1
	109,30	142,10	120,30	142,10	120,30	120,30	
SCATTO GM MANCP Q 10 PY Coppia maniglioni a scatto Q10 placca yale <i>Pair of pull handle Q10 w/ cyl. hole</i>	5GM96620501	5GM96620503	5GM96620504	5GM96620507	5GM96620508	5GM96620510	1
	109,30	142,10	120,30	142,10	120,30	120,30	



GCTOL



F1

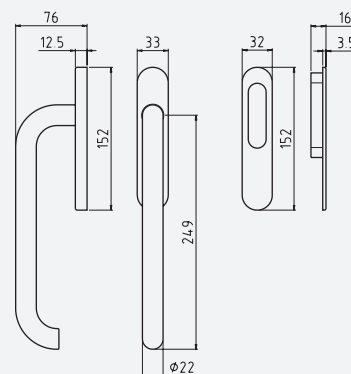

	F1	F4	GCTOL	F1-SAT	Conf. p.z.
SCATTO MAN PC CONCH. Maniglione a scatto placca chiusa con conchiglia <i>Pull handle for sliding door-closed plate -</i>	77980601001	77980601004	77980601012	77980601033	1
	46,10	46,10	58,80	58,80	
SCATTO MAN PC PY Maniglione a scatto placca yale <i>Pull handle for sliding door w/cyl. hole</i>	77980601501	77980601504	77980601512	77980601533	1
	40,70	40,70	51,90	51,90	
SCATTO MANCP Q 10 PC Coppia maniglioni a scatto Q10 placca chiusa <i>Pair of pull handle Q10 - closed plate</i>	77980620001	77980620004	77980620012	77980620033	1
	81,30	81,30	103,70	103,70	
SCATTO MANCP Q 10 PY Coppia maniglioni a scatto Q10 placca yale <i>Pair of pull handle Q10 w/ cyl. hole</i>	77980620501	77980620504	77980620512	77980620533	1
	81,30	81,30	103,70	103,70	
CONCH MAN SCATT Conchiglia per maniglione a scatto <i>Sliding handle</i>	77980680901	77980680904	77980680912	77980680933	12
	6,20	6,20	6,70	6,70	

COORDINATI E COMPLEMENTI D'ARREDO - ARTICOLI VARI *ACCESSORIES AND FURNITURE FITTINGS - MISCELLANEOUS ITEMS*

COPRIAVVOLGIBILI
COVERS 489-490

COPRINTERRUTORI
SWITCH COVERS 488

GANCI BAGNO
HOOKS 496

PIEDINI 496-497

POMELLI FERMAPORTA
STOP DOOR 491

POMOLI PER MOBILI
KNOBS FOR FURNITURE 492-493-494

RULTAP 490

SUPPORTI CORRIMANO
HAND RAIL BRACKETS 495

ARTICOLI VARI
MISCELLANEOUS ITEMS

BUCALETTRE ARIANNA 484

COPRIDADI 484

CRICCHETTI 486

GANCI RIGIDI 485

NOTTOLINI 487

NOTTOLINI A SCATTO 487

PINZE 486

GIOIA



OLV-M1

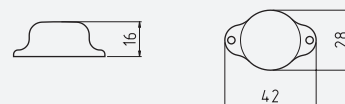

	OLV M1	OCS M18	OGV M27	OS M2	Conf. pz.
CDADO	55448000001	55448000003	55448000004	55448000008	
Copridado	2,80	3,40	2,80	2,80	50
<i>Cover nut</i>					

ARIANNA

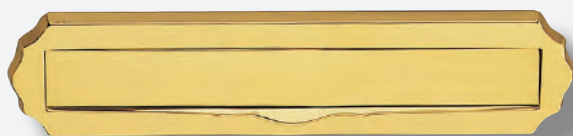

OLV-M1

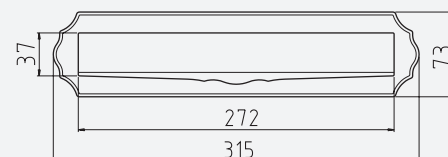

	OLV M1	OF M3	Conf. pz.
BLETT	55648400001	55648400006	
Bucalettere	38,60	38,60	4
<i>Letter plate</i>			

GANCI RIGIDI

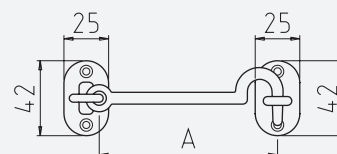

	A
MM. 80	80
MM.100	100
MM.120	120
MM.140	140

OLV-M1

	OBR M45	OLV M1	OC M4	Conf. pz.
GANCIO MM80 RIG Gancio rigido mm 80 <i>Hook mm.80</i>	49208080000	49208080001	49208080003	24
	5,10	5,10	5,50	
GANCIO MM100 RIG Gancio rigido mm 100 <i>Hook mm.100</i>	49208100000	49208100001	49208100003	24
	5,40	5,40	5,80	
GANCIO MM120 RIG Gancio rigido mm 120 <i>Hook mm. 120</i>	49208120000	49208120001	49208120003	24
	5,60	5,60	6,00	
GANCIO MM140 RIG Gancio rigido mm 140 <i>Hook mm.140</i>	49208140000	49208140001	49208140003	24
	5,90	5,90	6,30	



**INCONTRO
A STAFFA**



**INCONTRO
NORMALE**

CRICCHETTI

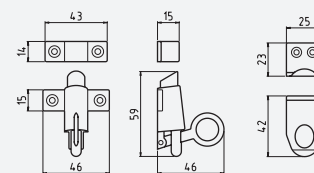

	OBR M45	OL M23	Conf. pz.
CRICCHETT INC NORM Cricchetto con incontro normale <i>Window hook</i>	49204100000	49204100001	25
	3,80	3,80	
CRICCHETT INC STAFFA Cricchetto con incontro a staffa <i>Window hook</i>	49204200000	49204200001	25
	3,90	3,90	

PINZE FERMAPORTE

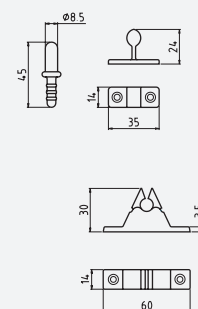

	OBR M45	OL M23	Conf. pz.
PINZA F/PORT Pinza fermaporta <i>Door stop pliers</i>	49206000000	49206000001	50
	2,80	2,80	
PRESA PINZA LEGNO Pres a legno per pinza <i>Fitting for door stop plier</i>	49206500000	49206500001	50
	1,65	1,65	
PRESA PINZA TERRA Pres a terra per pinza <i>Fitting for door stop plier</i>	49206520000	49206520001	50
	1,30	1,30	

NOTTOLINI

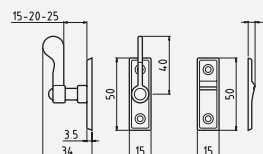

	OBR M45	OL M23	Conf. pz.
NOTTOLINO MM 15	49210015000	49210015001	
<i>Safety lever handle</i>	2,50	2,50	50
NOTTOLINO MM 20	49210020000	49210020001	
<i>Safety lever handle</i>	2,50	2,50	50
NOTTOLINO MM 25	49210025000	49210025001	
<i>Safety lever handle</i>	2,50	2,50	50

NOTTOLINI A SCATTO

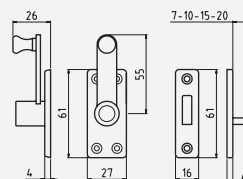
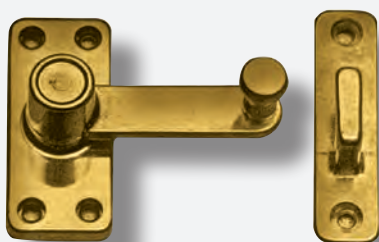

	OBR M45	OL M23	Conf. pz.
NOTTOLINO SCATT 5/I Nottolino a scatto senza incontro <i>Safety lever handle without hook</i>	49210100500	49210100501	50
INCONTRO NOTT SCATT 7 Incontro mm. 7 per nottolino a scatto <i>Hook mm.7</i>	49210107100	49210107101	50
INCONTRO NOTT SCATT 10 Incontro mm. 10 per nottolino a scatto <i>Hook mm.10</i>	49210110100	49210110101	50
INCONTRO NOTT SCATT 15 Incontro mm. 15 per nottolino a scatto <i>Hook mm.15</i>	49210115100	49210115101	50
INCONTRO NOTT SCATT 20 Incontro mm. 20 per nottolino a scatto <i>Hook mm.20</i>	49210120100	49210120101	50

GIOIA



OLV-M1

	A	B	C	D	E
MAGIC S/F	70	139	/	/	97
MAGIC 1P	70	139	33,5	16,8	97
MAGIC 2P	70	139	33,5	16,8	97
MAGIC 3P	70	139	33,5	16,8	97
MAGIC 4P	70	164	33,5	16,8	120
MAGIC 5P	70	187	33,5	16,8	144

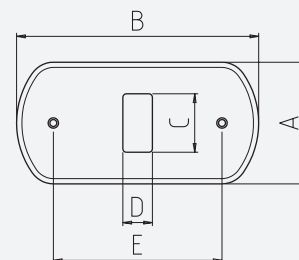

	OLV M1	OLS M33	OCS M18	OGV M27	OCL M4	Conf. pz.
COPR MAGIC S/F Coprinteruttore Magic senza fori (cieco) <i>Switch cover</i>	55448900001 6,00	55448900002 6,00	55448900003 11,00	55448900004 6,00	55448900007 11,00	12
COPR MAGIC 1P Coprinteruttore Magic 1 posto <i>Switch cover 1 hole</i>	55448900101 6,00	55448900102 6,00	55448900103 11,00	55448900104 6,00	55448900107 11,00	12
COPR MAGIC 2P Coprinteruttore Magic 2 posti <i>Switch cover 2 holes</i>	55448900201 6,00	55448900202 6,00	55448900203 11,00	55448900204 6,00	55448900207 11,00	12
COPR MAGIC 3P Coprinteruttore Magic 3 posti <i>Switch cover 3 holes</i>	55448900301 6,00	55448900302 6,00	55448900303 11,00	55448900304 6,00	55448900307 11,00	12
COPR MAGIC 4P Coprinteruttore Magic 4 posti <i>Switch cover 4 holes</i>	55448900401 6,40	55448900402 6,40	55448900403 11,30	55448900404 6,40	55448900407 11,30	12
COPR MAGIC 5P Coprinteruttore Magic 5 posti <i>Switch cover 5 holes</i>	55448900501 6,40	55448900502 6,40	55448900503 11,30	55448900504 6,40	55448900507 11,30	12

GIOIA



OLV-M1

Al fine di evitare un deterioramento della finitura si consiglia di ricavare il secondo foro vite forando dal retro

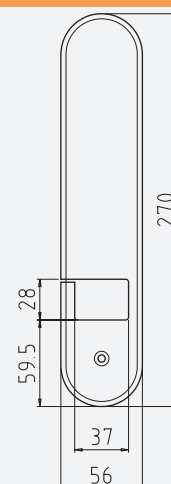

	OLV M1	OLS M33	OCS M18	OGV M27	OCL M4	Conf. pz.
AVV	55448800001	55448800002	55448800003	55448800004	55448800007	
Copriavvolgibile						12
<i>Cover</i>	17,60	17,60	21,90	17,60	21,90	

GIOIA



OLV-M1

Al fine di evitare un deterioramento della finitura si consiglia di ricavare il secondo foro vite forando dal retro

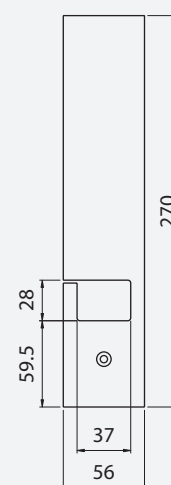

	OLV M1	OCS M18	OGV M27	OCL M4	OS M2	Conf. pz.
AVV	44998800001	44998800003	44998800004	44998800007	44998800008	
Copriavvolgibile						12
<i>Cover</i>	17,60	21,90	17,60	21,90	17,60	



F4



GCTOL

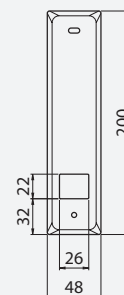

	F1	F4	GCTOL	Conf. pz.
AVV	77448800001	77448800004	77448800012	24
Copriavvolgibile				
Cover	2,80	2,80	6,90	

RULTAP



OLV-M1

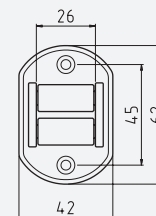
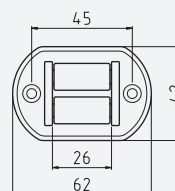

	OBR M45	OLV M1	OCS M18	Conf. pz.
RULTAP ORIZZ	55748326000	55748326001	55748326003	24
	9,80	9,80	14,20	
RULTAP VERT	55748327000	55748327001	55748327003	24
	9,80	9,80	14,20	

POMELLI FERMAPORTE



GCTNS

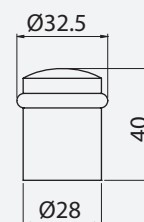

	F1	F4	GCTOL	GCTNS	Conf. pz.
POM F/POR GOMMA	77225000001	77225000004	77225000012	77225000027	
Pomello fermaporta con gommino	3,80	3,80	4,60	4,60	25
<i>Stop door</i>					

POMELLI FERMAPORTE



OLV-M1



	OBR M45	OLV M1	OCL M4	Conf. pz.
POM F/POR GOMMA	49225000000	49225000001	49225000007	
Pomello fermaporta con gommino	5,10	5,10	5,50	25
<i>Stop door</i>				

MILENA



OLV-M1

	A	B	C
D.20	20	21	20
D.25	25	24	25
D.30	30	28	30
D.35	35	33	35

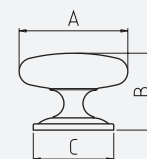

	OLV M1	Conf. pz.
POM20 Pomolo mm 20 <i>knob mm 20</i>	55744720001 3,60	50
POM25 Pomolo mm 25 <i>knob mm 25</i>	55744725001 4,50	40
POM30 Pomolo mm 30 <i>knob mm 30</i>	55744730001 6,80	25
POM35 Pomolo mm 35 <i>knob mm 35</i>	55744735001 8,30	20

POMOLI ZIGRINATI



	A	B	C
D.12	12	20	12
D.14	14	23	14
D.16	16	26	16
D.18	18	29	18
D.20	20	30	20

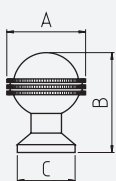

	A	B	C
D.25	25	32	21
D.30	30	38	22
D.35	35	47	22
D.40	40	55	29
D.45	45	63	29
D.50	50	68	29
D.60	60	88	36
D.70	70	98	37

	GREZZO	Conf. pz.
POM ZIGR MM 12 FORO PASSANTE	49222012001	250
<i>Knob mm. 12 - through hole</i>	0,75	
POM ZIGR MM 14 FORO PASSANTE	49222014001	120
<i>Knob mm. 14 - through hole</i>	1,20	
POM ZIGR MM 16 FORO PASSANTE	49222016001	85
<i>Knob mm. 16 - through hole</i>	1,60	
POM ZIGR MM 18 FORO PASSANTE	49222018001	60
<i>Knob mm. 18 - through hole</i>	1,85	
POM ZIGR MM 20 FORO PASSANTE	49222020001	50
<i>Knob mm. 20 - through hole</i>	2,20	
POM ZIGR MM 25 M8	49222025001	30
<i>Knob mm. 25 M8</i>	3,20	
POM ZIGR MM 30 M8	49222030001	20
<i>Knob mm. 30 M8</i>	4,50	
POM ZIGR MM 35 M10	49222035001	24
<i>Knob mm. 35 M10</i>	5,00	
POM ZIGR MM 40 M10	49222040001	24
<i>Knob mm. 40 M10</i>	6,10	
POM ZIGR MM 45 M10	49222045001	24
<i>Knob mm. 45 M10</i>	7,90	
POM ZIGR MM 50 M10	49222050001	6
<i>Knob mm. 50 M10</i>	9,00	
	OLNV M23	Conf. pz.
POM ZIGR MM 60 M12	49222060001	5
<i>Knob mm. 60 M12</i>	16,10	
POM ZIGR MM 70 M14	49222070001	5
<i>Knob mm. 70 M14</i>	19,50	

POMOLI A SFERA



OLNV-M23

	A	B	C
D.25	24	35	21
D.30	30	43	22
D.40	39	55	24
D.50	49	67	28
D.60	59	86	36
D.70	68	98	37

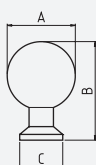

OLNV-M23

	A	B	C
D.25	24	26	11
D.30	29	31	13
D.40	39	42	14
D.50	49	53	15
D.60	58	64	16
D.70	68	73	18

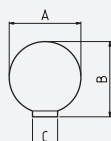

	OLNV M23	Conf. pz.
POM SFERA MM 25 GAMBO M8	49223025001	25
<i>Ball knob mm.25 shank M8</i>	4,60	
POM SFERA MM 30 GAMBO M8	49223030001	20
<i>Ball knob mm.30 shank M8</i>	7,20	
POM SFERA MM 40 GAMBO M10	49223040001	24
<i>Ball knob mm.40 shank M10</i>	7,90	
POM SFERA MM 50 GAMBO M10	49223050001	6
<i>Ball knob mm.50 shank M10</i>	11,70	
POM SFERA MM 60 GAMBO M12	49223060001	5
<i>Ball knob mm.60 shank M12</i>	14,70	
POM SFERA MM 70 GAMBO M14	49223070001	5
<i>Ball knob mm.70 shank M14</i>	19,50	

	OLNV M23	Conf. pz.
POM SFERA MM 25 S/GAM M8	49224025001	25
<i>Ball knob mm.25 M8</i>	4,30	
POM SFERA MM 30 S/GAM M8	49224030001	20
<i>Ball knob mm.30 M8</i>	6,50	
POM SFERA MM 40 S/GAM M10	49224040001	24
<i>Ball knob mm.40 M10</i>	7,90	
POM SFERA MM 50 S/GAM M10	49224050001	6
<i>Ball knob mm.50 M10</i>	11,70	
POM SFERA MM 60 S/GAM M12	49224060001	5
<i>Ball knob mm.60 M12</i>	14,70	
POM SFERA MM 70 S/GAM M14	49224070001	5
<i>Ball knob mm.70 M14</i>	19,50	

SUPPORTI PER CORRIMANO



OLV-M1



OCS-M18

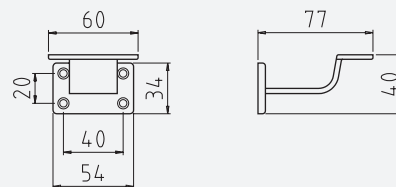

	OBR M45	OLV M1	OCS M18	Conf. pz.
SUPPORTO QUADR CORR	49235101000	49235101001	49235101003	
Supporto corrimano quadro				24
<i>Hand rail bracket</i>	7,60	6,80	7,60	



OLV-M1

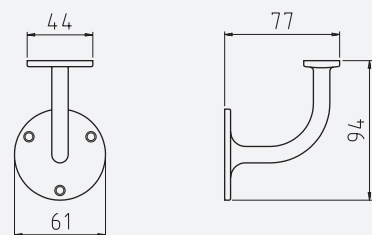

	OBR M45	OLV M1	Conf. pz.
SUPPORTO TONDO CORR	49235201000	49235201001	
Supporto corrimano tondo			12
<i>Hand rail bracket</i>	13,00	12,30	



OLV-M1

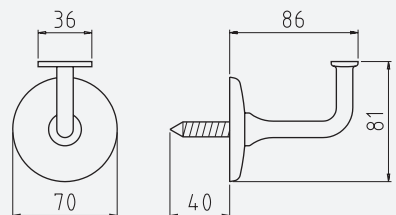

	OBR M45	OLV M1	Conf. pz.
SUPPORTO TONDO CORR C/V	49235251000	49235251001	
Supporto corrimano tondo con vite			12
<i>Hand rail bracket with screw</i>	15,10	14,40	

GANCI



OCL-M4

	A	B	C
PICCOLO	36	23	14
MEDIO	41	30	16
GRANDE	48	38	16

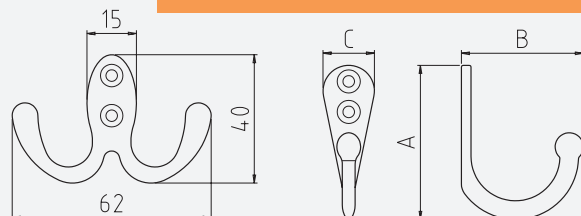

	OCL M4	Conf. pz.
GANCIO PIC BAGNO Gancio per bagno piccolo <i>Hook</i>	49216100003 1,40	200
GANCIO MED BAGNO Gancio per bagno medio <i>Hook</i>	49216200003 1,55	100
GANCIO GRA BAGNO Gancio per bagno grande <i>Hook</i>	49216300003 1,75	100
GANCIO DOPPIO BAGNO Gancio per bagno doppio <i>Double hook</i>	49216500003 2,05	50

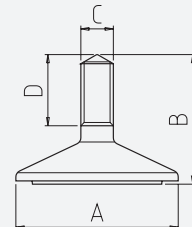

PIEDINI

	A	B	C	D
30 M10	30	28	M10	15
35 M10	35	32	M10	18
40 M10	40	32	M10	17
50 M10	50	40	M10	22
60 M10	60	55	M10	30
50 M12	50	40	M12	22
60 M12	60	50	M12	26

	GREZZO	Conf. pz.
PIED.FIS.MM30 M10 C/G Piedino fisso mm 30 M10 con gomma <i>Accessories for furniture</i>	49218103001 2,30	200
PIED.FIS.MM35 M10 C/G Piedino fisso mm 35 M10 con gomma <i>Accessories for furniture</i>	49218103501 2,70	200
PIED.FIS.MM40 M10 C/G Piedino fisso mm 40 M10 con gomma <i>Accessories for furniture</i>	49218104001 3,20	100
PIED.FIS.MM50 M10 C/G Piedino fisso mm 50 M10 con gomma <i>Accessories for furniture</i>	49218105001 4,00	100
PIED.FIS.MM60 M10 C/G Piedino fisso mm 60 M10 con gomma <i>Accessories for furniture</i>	49218106001 5,80	100
PIED.FIS.MM50 M12 C/G Piedino fisso mm 50 M12 con gomma <i>Accessories for furniture</i>	49218125001 4,80	100
PIED.FIS.MM60 M12 C/G Piedino fisso mm 60 M12 con gomma <i>Accessories for furniture</i>	49218126001 6,60	100

PIEDINI

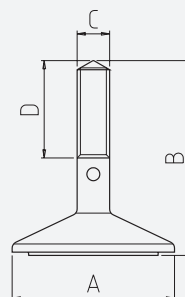

	A	B	C	D
50 M12	50	60	M12	30
60 M12	60	60	M12	30

	GREZZO	Conf. pz.
PIED.REG.MM50 M12 C/G Piedino regolabile mm 50 M12 con gomma <i>Accessories for furniture</i>	49219125001 7,00	60
PIED.REG.MM60 M12 C/G Piedino regolabile mm 60 M12 con gomma <i>Accessories for furniture</i>	49219126001 8,30	50

PIEDINI

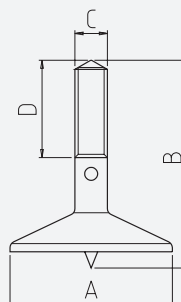

	A	B	C	D
50 M12	50	65	M12	30
60 M12	60	65	M12	30

	GREZZO	Conf. pz.
PIED.REG.MM50 M12 C/P Piedino regolabile mm 50 M12 con punta <i>Accessories for furniture</i>	49217125001 7,00	60
PIED.REG.MM60 M12 C/P Piedino regolabile mm 60 M12 con punta <i>Accessories for furniture</i>	49217126001 8,30	50



POMOLI KNOBS

■ ARIANNA	510
■ ARES	512
■ AURORA	508
■ BLINDO	507
■ BLINDO	503
■ FRAME	511
■ GIOIA	508
■ GM	504
■ MARGHERITA	510
■ MILENA	505
■ PEGASO	506
■ PEGASO	502
■ SFERA	509
■ SOGNO	512
■ SUSY	501
■ UNIVERSAL	500
■ WING	511



GCTOL



F4

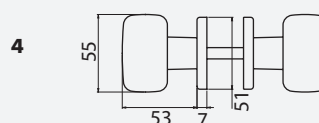
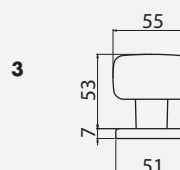
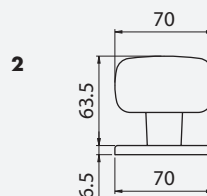
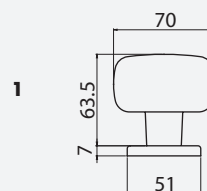

	F1	F4	GCTOL	GCTOS	GCTCL	GCTCS
1	POM70 CP R51x7					
	Pomolo mm 70 centroporta rosetta 51x7	77486770501	77486770504	77486770512	77486770523	77486770524
		12,30	12,30	14,40	18,70	14,40
						18,70
2	POM70 CP R70x6					
	Pomolo mm 70 centroporta rosetta 70x6	7748687560107	7748687560407	7748687561207	7748687562307	7748687562407
		7748687562507	12,70	12,70	14,80	19,20
						14,80
						19,20
3	POM55 CP R51x7					
	Pomolo mm 55 centroporta rosetta 51x7	77486755501	77486755504	77486755512	77486755523	77486755524
		77486755525	9,90	9,90	11,80	15,40
						11,80
						15,40
4	POM55 Q8CP R51x7					
	Pomoli mm 55 Q8 accoppiati rosetta 51x7	77486751001	77486751004	77486751012	77486751023	77486751024
		77486751025	19,80	19,80	23,60	30,70
						23,60
						30,70



GCTOL

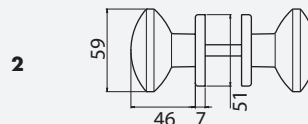
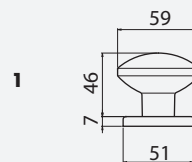

F4

	F1	F4	GCTOL	GCTOS	GCTCL	GCTCS
1	POM60 CP R51x7					
	Pomolo mm 60 centroporta rosetta 51x7					
	77434755501	77434755504	77434755512	77434755523	77434755524	77434755525
	9,90	9,90	11,80	15,40	11,80	15,40
2	POM60 Q8CP R51x7					
	Pomoli mm 60 Q8 accoppiati rosetta 51x7					
	77434751001	77434751004	77434751012	77434751023	77434751024	77434751025
	19,80	19,80	23,60	30,70	23,60	30,70



GCTOL



F4

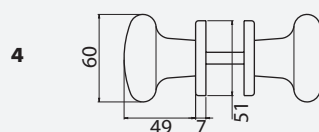
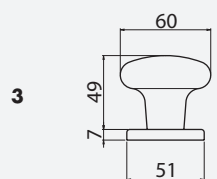
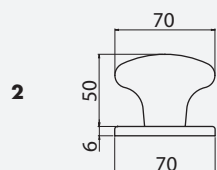
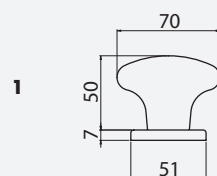

	F1	F4	GCTOL	GCTOS	GCTCL	GCTCS	
1	POM70 CP R51x7						
	Pomolo mm 70 centroporta rosetta 51x7	70143770501	70143770504	70143770512	70143770523	70143770524	70143770525
		12,30	12,30	14,40	18,70	14,40	18,70
2	POM70 CP R70x6						
	Pomolo mm 70 centroporta rosetta 70x6	7014387560107	7014387560407	7014387561207	7014387562307	7014387562407	7014387562507
		12,70	12,70	14,80	19,20	14,80	19,20
3	POM60 CP R51x7						
	Pomolo mm 60 centroporta rosetta 51x7	70143755501	70143755504	70143755512	70143755523	70143755524	70143755525
		9,90	9,90	11,80	15,40	11,80	15,40
4	POM60 Q8CP R51x7						
	Pomoli mm 60 Q8 accoppiati rosetta 51x7	70143751001	70143751004	70143751012	70143751023	70143751024	70143751025
		19,80	19,80	23,60	30,70	23,60	30,70



GCTOL



F4

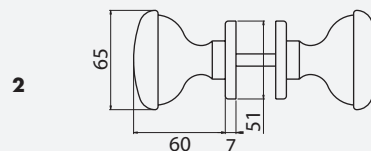
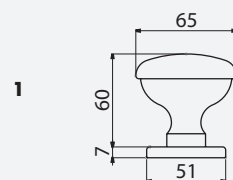

	F1	F4	GCTOL	GCTOS	GCTCL	GCTCS
1 POM65 CP R51x7 Pomolo mm 65 centroporta rosetta 51x7	77194770501	77194770504	77194770512	77194770523	77194770524	77194770525
	9,90	9,90	11,80	15,40	11,80	15,40
2 POM65 Q8CP R51x7 Pomoli mm 65 Q8 accoppiati rosetta 51x7	77194771001	77194771004	77194771012	77194771023	77194771024	77194771025
	19,80	19,80	23,60	30,70	23,60	30,70



OLV-M1

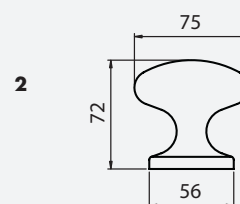
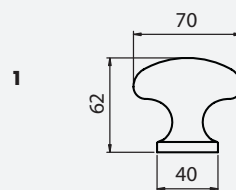

	OLV M1	OCS M18	OGV M27	OCL M4	OS M2	G-PLUS M36	Conf. pz.
1	POM. 70 CP						
	Pomolo mm. 70 centroporta						
	<i>Fixed knob dia. mm 70</i>						
	5GM96770301	5GM96770303	5GM96770304	5GM96770307	5GM96770308	5GM96770350	6
	17,40	21,80	19,10	21,80	19,10	32,40	
2	POM. 75 CP						
	Pomolo mm. 75 centroporta						
	<i>Fixed knob dia. mm 75</i>						
	5GM96770501	5GM96770503	5GM96770504	5GM96770507	5GM96770508	5GM96770550	6
	17,40	21,80	19,10	21,80	19,10	32,40	



OLV-M1

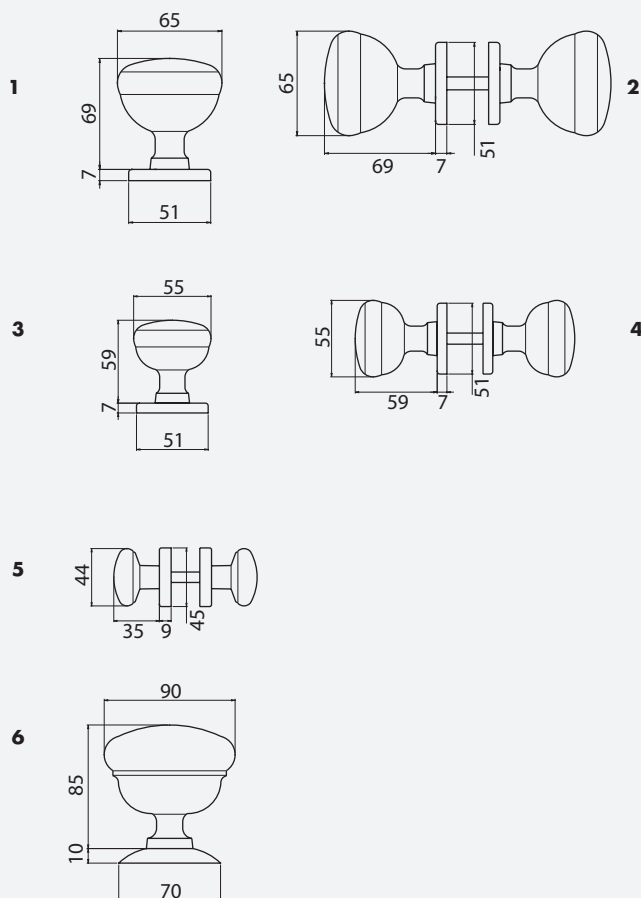

	OLV M1	OCS M18	OGV M27	OCL M4	OS M2	G-PLUS M36	
1	POM70 CP R51x7 Pomolo mm 70 centroporta rosetta 51x7	55744770501	55744770503	55744770504	55744770507	55744770508	55744770550
	26,00	32,50	26,00	32,50	26,00	42,70	
2	POM70 Q8CP R51x7 Pomoli mm 70 Q8 accoppiati rosetta 51x7	55744771001	55744771003	55744771004	55744771007	55744771008	n.d.
	43,70	53,30	43,70	53,30	43,70		
3	POM55 CP R51x7 Pomolo mm 55 centroporta rosetta 51x7	55744755501	55744755503	55744755504	55744755507	55744755508	55744755550
	21,90	26,70	21,90	26,70	21,90	38,60	
4	POM55 Q8CP R51x7 Pomoli mm 55 Q8 accoppiati rosetta 51x7	55744751001	55744751003	55744751004	55744751007	55744751008	n.d.
	39,30	44,40	39,30	44,40	39,30		
5	POM45 Q8CP R45x9 Pomoli mm 45 Q8 accoppiati rosetta 45x9	55744741001	55744741003	55744741004	55744741007	55744741008	n.d.
	35,50	40,30	35,50	40,30	35,50		
6	POM90 C/V R70 Pomolo mm 90 con vite passante rosetta mm 70	55744790001	55744790003	55744790004	55744790007	55744790008	n.d.
	43,10	52,70	43,10	52,70	43,10		



OLV-M1

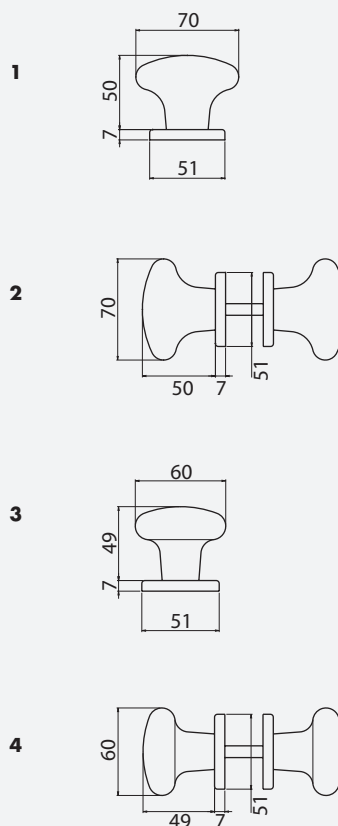

	OLV M1	OCS M18	OGV M27	OCL M4	OS M2	G-PLUS M36
1	POM70 CP R51x7					
	Pomolo mm 70 centroporta rosetta 51x7	44890770501	44890770503	44890770504	44890770507	44890770550
		22,60	29,10	24,90	29,10	36,40
2	POM70 Q8CP R51x7					
	Pomoli mm 70 Q8 accoppiati rosetta 51x7	44890771001	44890771003	44890771004	44890771007	44890771050
		45,30	58,20	49,80	58,20	72,80
3	POM60 CP R51x7					
	Pomolo mm 60 centroporta rosetta 51x7	44890755501	44890755503	44890755504	44890755507	44890755550
		21,30	27,80	23,60	27,80	35,10
4	POM60 Q8CP R51x7					
	Pomoli mm 60 Q8 accoppiati rosetta 51x7	44890751001	44890751003	44890751004	44890751007	44890751050
		42,60	55,60	47,10	55,60	70,10



OLV-M1

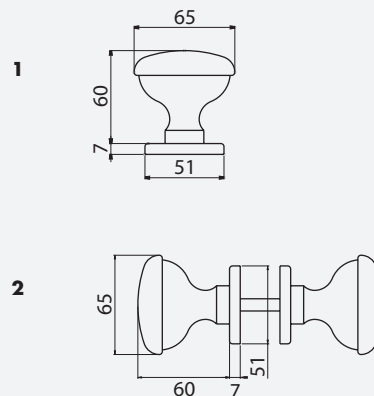

	OLV M1	OCS M18	OGV M27	OCL M4	OS M2	G-PLUS M36
1 POM65 CP R51x7 Pomolo mm 65 centroporta rosetta 51x7	55694770501	55694770503	55694770504	55694770507	55694770508	55694770550
	21,30	27,80	23,60	27,80	23,60	35,10
2 POM65 Q8CP R51x7 Pomoli mm 65 Q8 accoppiati rosetta 51x7	55694771001	55694771003	55694771004	55694771007	55694771008	55694771050
	42,60	55,60	47,10	55,60	47,10	70,10

AURORA



OLV-M1

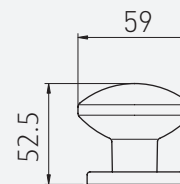

	OLV M1	OCS M18	OGV M27	OCL M4	Conf. pz.
POM60 CP R50x7 Pomolo mm 60 centroporta <i>Fixed knob dia. 60 mm</i>	5504275550114	5504275550314	5504275550414	5504275550714	8
	16,60	19,80	16,60	19,80	

GIOIA



OLV-M1

Ø (mm)	A (mm)	B (mm)
55	54	67
70	67	75
90	90	96

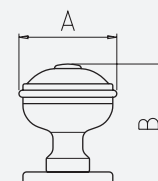

	OLV M1	OLS M33	OGV M27	Conf. pz.
POM55 Q8CP RST R58 Coppia pomoli mm 55 Q8 rosetta staccata <i>Pair of knobs dia. 55mm Q8 detached rose</i>	55430751001	55430751002	55430751004	4
	40,70	40,70	40,70	
POM55 CP R51 Pomolo mm 55 centroporta <i>Fixed knob dia. 55mm</i>	55430755501	55430755502	55430755504	8
	23,30	23,30	23,30	
POM70 Q8CP RST R58 Coppia pomoli mm 70 Q8 rosetta staccata <i>Pair of knobs dia. 70 mm Q8 detached rose</i>	55430771001	55430771002	55430771004	3
	46,50	46,50	46,50	
POM70 CP R51 Pomolo mm 70 centroporta <i>Fixed knob dia. 70mm</i>	55430770501	55430770502	55430770504	6
	27,40	27,40	27,40	
POM90 C/V R70 Pomolo mm 90 con vite <i>Fixed knob dia. 90mm</i>	55430790001	55430790002	55430790004	4
	44,40	44,40	44,40	

SFERA



OLV-M1

Ø (mm)	A (mm)	B (mm)
55	50	80
70	64	85

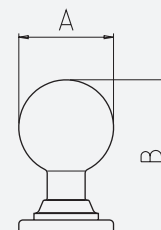

	OLV M1	OCS M18	OGV M27	OCL M4	OS M2	G-PLUS M36	Conf. pz.
POM55 Q8CP RST R58 Coppia pomoli mm 55 Q8 rosetta staccata <i>Pair of knobs dia.55mm Q 8 detached rose</i>	55990751001	55990751003	55990751004	55990751007	55990751008	n.d.	6
	42,40	47,50	42,40	47,50	42,40		
POM55 CP R51 Pomolo mm 55 centroporta <i>Fixed knob dia.55mm</i>	55990755501	55990755503	55990755504	55990755507	55990755508	55990755550	8
	24,90	29,80	24,90	29,80	24,90	41,70	
POM70 Q8CP RST R58 Coppia pomoli mm 70 Q8 rosetta staccata <i>Pair of knobs dia.70 mm Q 8 detached rose</i>	55990771001	55990771003	55990771004	55990771007	55990771008	n.d.	3
	46,80	56,40	46,80	56,40	46,80		
POM70 CP R51 Pomolo mm 70 centroporta <i>Fixed knob dia.70mm</i>	55990770501	55990770503	55990770504	55990770507	55990770508	55990770550	6
	29,10	35,50	29,10	35,50	29,10	45,80	

ARIANNA



OFA-M69

Ø (mm)	A (mm)	B (mm)
55	55	65
70	66	77

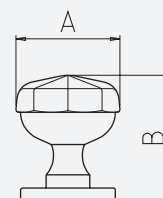

		OLV M1	OGV M27	OF M3	OLD MV3	OFA M69	Conf. pz.
POM55 Q8CP RST	R58	55640751001	55640751004	55640751006	55640751028	55640751029	
Coppia pomoli mm 55 Q8 rosetta staccata		39,30	39,30	39,30	39,30	58,50	6
<i>Pair of knobs dia.55mm Q8 detached rose</i>							
POM55 CP	R51	55640755501	55640755504	55640755506	55640755528	55640755529	
Pomolo mm 55 centroporta		21,90	21,90	21,90	21,90	36,80	8
<i>Fixed knob dia.55mm</i>							
POM70 Q8CP RST	R58	55640771001	55640771004	55640771006	55640771028	55640771029	
Coppia pomoli mm 70 Q8 rosetta staccata		43,70	43,70	43,70	43,70	62,90	3
<i>Pair of knobs dia.70 mm Q 8 detached rose</i>							
POM70 CP	R51	55640770501	55640770504	55640770506	55640770528	55640770529	
Pomolo mm 70 centroporta		26,00	26,00	26,00	26,00	35,60	6
<i>Fixed knob dia .70mm</i>							

MARGHERITA



OFA-M69

Ø (mm)	A (mm)	B (mm)
55	55	69
70	68	78

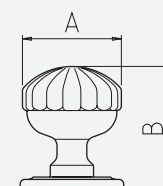

		OBR M45	OLD MV3	OFA M69	Conf. pz.
POM55 Q8CP RST	R58	44290751000	44290751028	44290751029	
Coppia pomoli mm 55 Q8 rosetta staccata		27,40	27,40	46,50	6
<i>Pair of knobs dia.55mm Q8 detached rose</i>					
POM55 CP	R51	44290755500	44290755528	44290755529	
Pomolo mm 55 centroporta		13,70	13,70	28,60	8
<i>Fixed knob dia.55mm</i>					
POM70 CP	R51	44290770500	44290770528	44290770529	
Pomolo mm 70 centroporta		20,50	20,50	30,10	6
<i>Fixed knob dia .70mm</i>					

WING



ACS

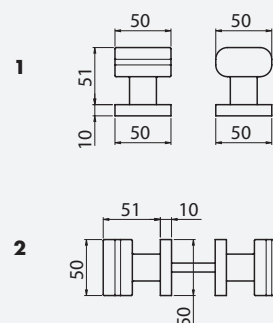

	ACS	ACL	Conf. pz.
1	POM50 CP R50x50 Pomolo mm50 centroporta ros.50x50 <i>Fixed knob 50mm rose 50x50</i>	77792755513 77792755517	2
	19,40	19,70	
2	POM50 Q8CP R50x50 Coppia pomoli mm50 Q8 ros.50x50 <i>Pair of knobs 50mm Q8 roses 50x50</i>	77792751013 77792751017	1
	40,40	40,40	

FRAME



F1-SAT

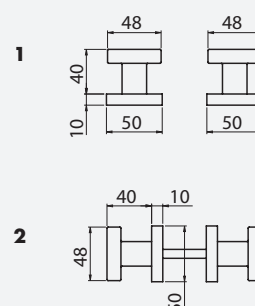

	ACL	F1-SAT	Conf. pz.
1	POM50 CP R50x50 Pomolo mm50 centroporta ros.50x50 <i>Fixed knob 50mm rose 50x50</i>	77472755517 77472755533	2
	21,20	17,20	
2	POM50 Q8CP R50x50 Coppia pomoli mm50 Q8 ros.50x50 <i>Pair of knobs 50mm Q8 roses 50x50</i>	77472751017 77472751033	1
	43,90	35,10	

SOGNO



ZCS

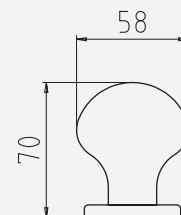

		GCTOL	ZCS	ZNS	Conf. pz.
POM55 Q8CP R	R45	66096751112	66096751113	66096751127	
Coppia pomoli mm 55 Q8		29,80	37,60	38,40	1
<i>Pair of knobs dia.55mm Q8 detached rose</i>					
POM55 CP	R51	66096755512	66096755513	66096755527	
Pomolo mm 55 centroporta		16,40	18,40	19,20	4
<i>Fixed knob dia.55mm</i>					

ARES



ZCS

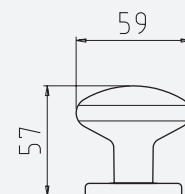

		GCTOL	ZCS	ZNS	Conf. pz.
POM55 Q8CP R	R45	66046751112	66046751113	66046751127	
Coppia pomoli mm 55 Q8		29,80	37,60	38,40	1
<i>Pair of knobs dia.55mm Q8 detached rose</i>					
POM55 CP	R51	66046755512	66046755513	66046755527	
Pomolo mm 55 centroporta		16,40	18,40	19,20	4
<i>Fixed knob dia.55mm</i>					

BATTENTI *DOOR KNOCKERS*

■ ANELLO	514
■ LEONE	517
■ MONACO	516
■ SPAGNA	516
■ SVEZIA	517
■ SOGNO	515

ANELLO



G-PLUS-M36

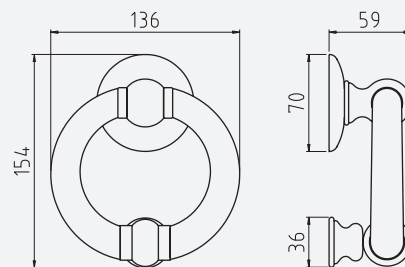

	OLV M1	OCS M18	OGV M27	OLD MV3	OFA M69	G-PLUS M36	Conf. pz.
BATTENTE ANELLO	55748200001	55748200003	55748200004	55748200028	55748200029	55748200050	
Battente ad anello							1
<i>Door knocker</i>	87,40	90,90	87,70	87,40	89,30	129,30	

SOGNO



G-PLUS

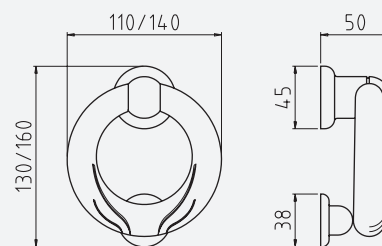

	GCTOL	ZCS	G-PLUS	Conf. pz.
BATT MM 140	66098210012	66098210013	66098210050	
Battente diametro mm 140				1
<i>Door knocker dia. 140 mm</i>	52,00	50,30	94,10	



G-PLUS

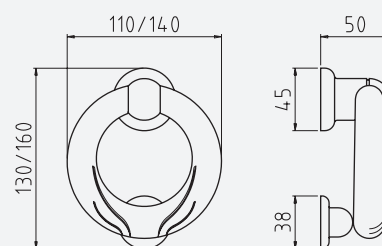

	GCTOL	ZCS	G-PLUS	Conf. pz.
BATT MM 110	66098200012	66098200013	66098200050	
Battente diametro mm 110				1
<i>Door knocker dia. 110 mm</i>	35,50	33,80	63,90	

MONACO



OLV-M1

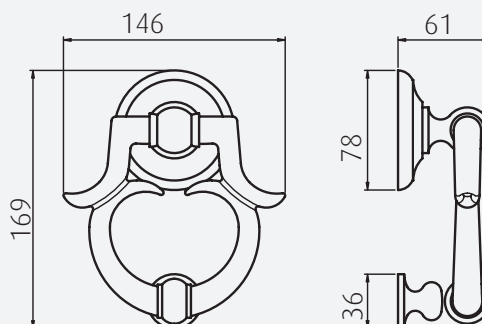

BATTENTE MONACO
Battente Monaco
 Door knocker

OLV M1	OGV M27	G-PLUS M36	Conf. pz.
55098217001	55098217004	55098217050	1
82,60	82,60	182,00	

SPAGNA



OLV-M1

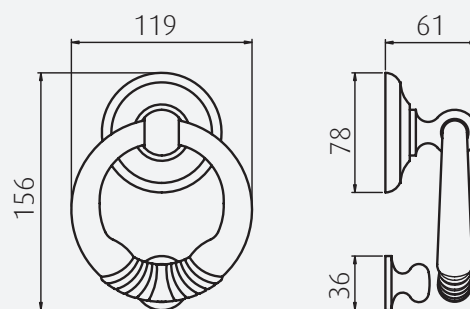

BATTENTE SPAGNA
Battente Spagna
 Door knocker

OLV M1	OGV M27	G-PLUS M36	Conf. pz.
55098215001	55098215004	55098215050	1
97,40	97,40	188,30	

SVEZIA



OLV-M1

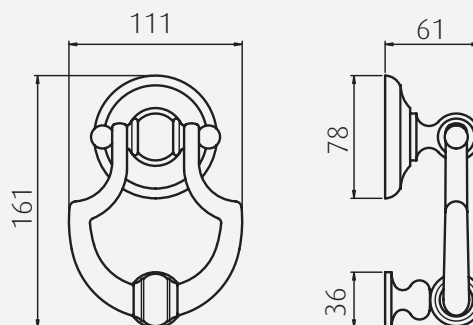

BATTENTE SVEZIA

Battente Svezia

Door knocker

OLV M1	OGV M27	G-PLUS M36	Conf. pz.
55098216001	55098216004	55098216050	1
98,90	98,90	191,30	

LEONE



OLV-M1

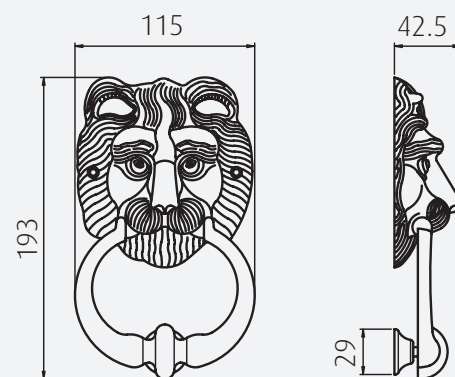

BATTENTE LEONE

Battente Leone

Door knocker

OLV M1	OGV M27	G-PLUS M36	Conf. pz.
55098218001	55098218004	55098218050	1
38,50	38,50	125,90	



COORDINATI PER BASCULANTI - PORTE BLINDATE ACCESSORIES FOR BALANCING AND ARMORED DOORS

KIT BASCULANTE

GARAGE DOORS KIT	520
PLACCHE GHIBLI	522
ROSETTE E BOCCHETTE GHIBLI	524
ROSETTE E BOCCHETTE GHIBLI-2	524
ROSETTE E BOCCHETTE MM 54	526
ROSETTE E BOCCHETTE MM 54	528

MANIGLIE

DOOR HANDLES

BRIXIA	530
DAFNE	530
ERICA	532
GM05	531
MILENA	531
SUSY	530
UNO	531

POMOLI

KNOBS

BLINDO	537
BLINDO	539
BRASILIA	533
MEZZALUNA	530
MEZZALUNA	532
MILENA	538
PEGASO	536
PEGASO	539
SUSY	535
UNIVERSAL	534

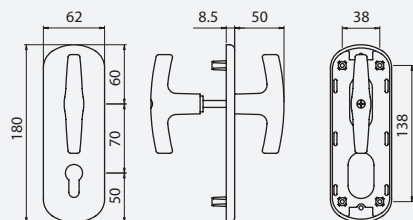
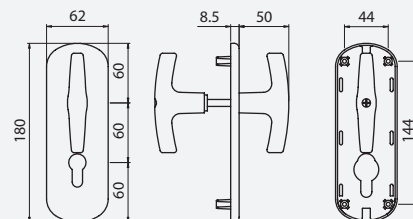

GCTOL

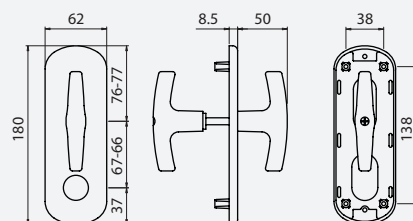
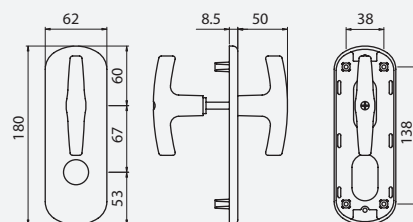

KIT BASCULANTE

	F1	F4	GCTOL	GCTOS	GCTCL	GCTCS	Conf. pz.
KIT BASCULANTE YALE 60	77400517001	77400517004	77400517012	77400517023	77400517024	77400517025	1
Kit per basculante yale 60	17,20	17,20	26,50	30,50	26,50	30,50	
<i>Garage door kit cylinder distance mm 60</i>							

KIT BASCULANTE YALE 70	77400517501	77400517504	77400517512	77400517523	77400517524	77400517525	1
Kit per basculante yale 70	17,20	17,20	26,50	30,50	26,50	30,50	
<i>Garage door kit cylinder distance mm 70</i>							

KIT BASCULANTE CIL D25 INT67	77400518001	77400518004	77400518012	77400518023	77400518024	77400518025	1
Kit per basculante foro cilindro D.25 int.67	17,20	17,20	26,50	30,50	26,50	30,50	
<i>Garage door kit round cylinder dia.25 distance mm 67</i>							

KIT BASCULANTE CIL D25 INT67 SP	77400518501	77400518504	77400518512	77400518523	77400518524	77400518525	1
Kit per basculante foro cilindro D.25 int.67 spostato	17,20	17,20	26,50	30,50	26,50	30,50	
<i>Garage door kit round cylinder dia.25 distance mm 67</i>							

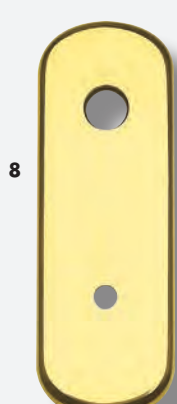
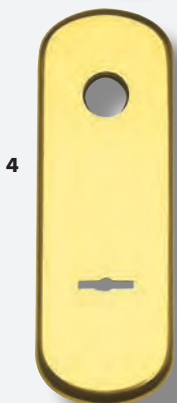
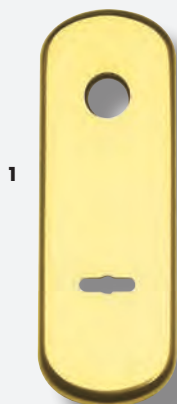

GCTOL

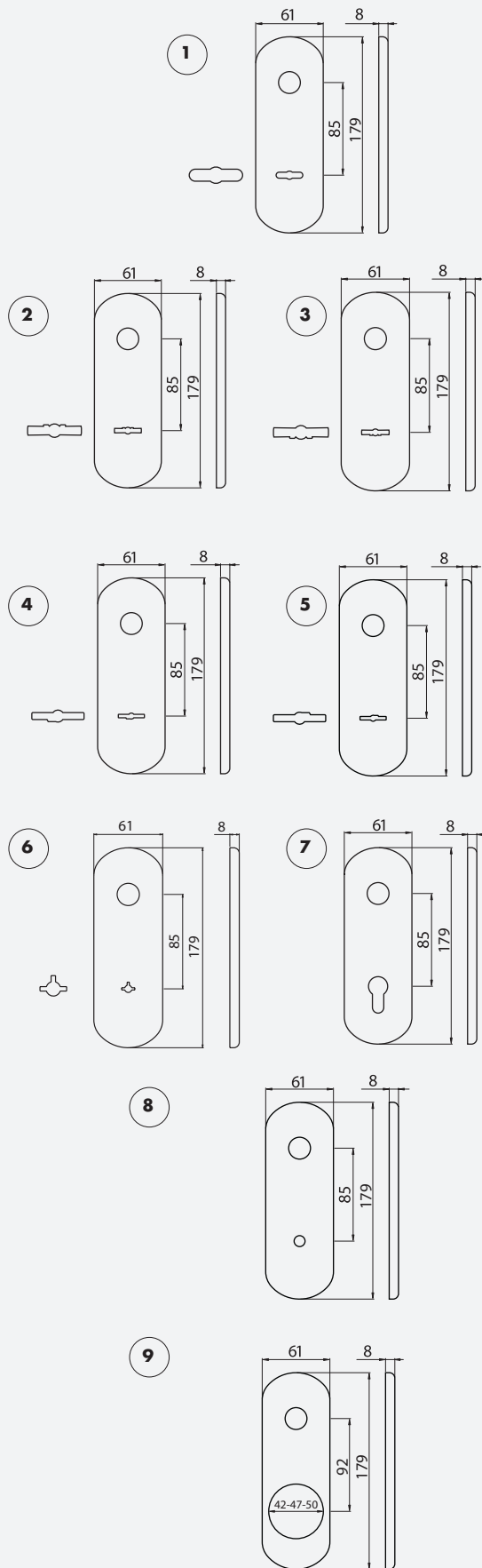

	F1	F4	GCTOL	GCTOS	GCTCL	GCTCS
1 PL DM/UNIV 85 Placca doppia mappa universale interasse 85 <i>Plate for safety lock</i>	77298852001	77298852004	77298852012	77298852023	77298852024	77298852025
	4,20	4,20	6,80	7,90	6,80	7,90
2 PL DM INT 85 Placca doppia mappa interna interasse 85 <i>Plate for safety lock</i>	77298852301	77298852304	77298852312	77298852323	77298852324	77298852325
	4,20	4,20	6,80	7,90	6,80	7,90
3 PL DM EST 85 Placca doppia mappa esterna interasse 85 <i>Plate for safety lock</i>	77298852401	77298852404	77298852412	77298852423	77298852424	77298852425
	4,20	4,20	6,80	7,90	6,80	7,90
4 PL DM/A 85 DX Placca doppia mappa Atra interasse 85 destra <i>Plate for safety lock</i>	77298852101	77298852104	77298852112	77298852123	77298852124	77298852125
	4,20	4,20	6,80	7,90	6,80	7,90
5 PL DM/A 85 SX Placca doppia mappa Atra interasse 85 sinistra <i>Plate for safety lock</i>	77298852201	77298852204	77298852212	77298852223	77298852224	77298852225
	4,20	4,20	6,80	7,90	6,80	7,90
6 PL OMEGA Placca OMEGA <i>Plate for OMEGA safety lock</i>	77298852901	77298852904	77298852912	77298852923	77298852924	77298852925
	4,20	4,20	6,80	7,90	6,80	7,90
7 PY85 Placca yale interasse 85 <i>Plate cylinder profile distance mm 85</i>	77298855001	77298855004	77298855012	77298855023	77298855024	77298855025
	4,20	4,20	6,80	7,90	6,80	7,90
8 PL F10 Placca foro D.10 per cilindro con pomolo int 85 <i>Plate for cylinder with knob distance mm 85</i>	77298858101	77298858104	77298858112	77298858123	77298858124	77298858125
	4,20	4,20	6,80	7,90	6,80	7,90
9 PL DEF42 Placca Defender D.42 <i>Plate for cylinder protection dia. 42</i>	77298856501	77298856504	77298856512	77298856523	77298856524	77298856525
	4,20	4,20	6,80	7,90	6,80	7,90
9 PL DEF47 Placca Defender D.47 <i>Plate for cylinder protection dia. 47</i>	77298856701	77298856704	77298856712	77298856723	77298856724	77298856725
	4,20	4,20	6,80	7,90	6,80	7,90
9 PL DEF50 Placca Defender D.50 <i>Plate for cylinder protection dia. 50</i>	77298856601	77298856604	77298856612	77298856623	77298856624	77298856625
	4,20	4,20	6,80	7,90	6,80	7,90



GCTOL

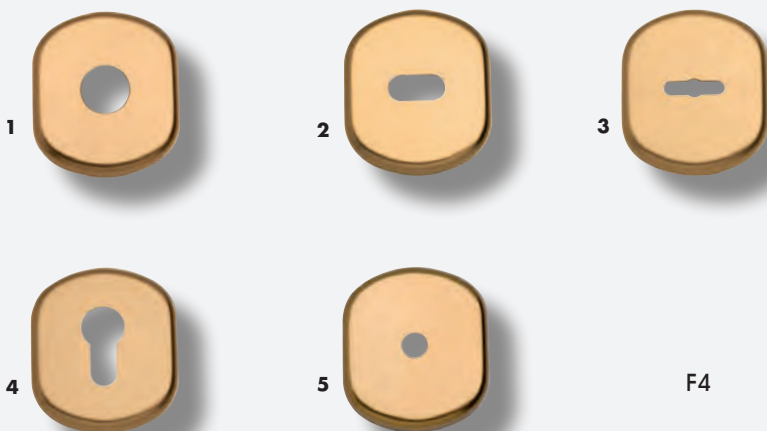
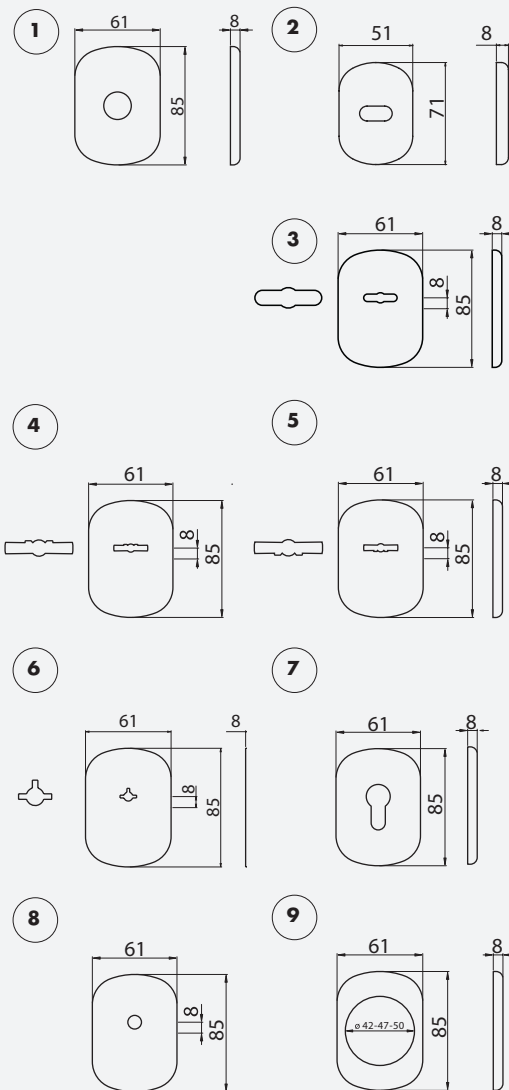

F4

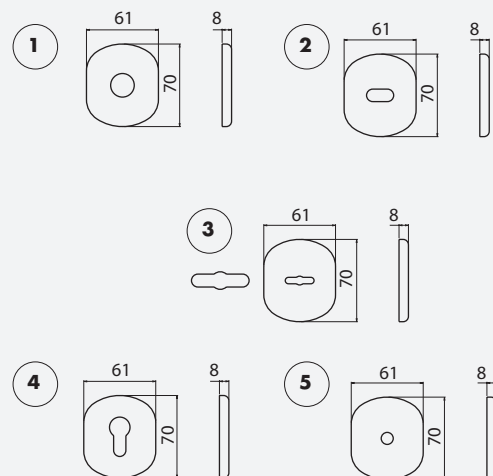

GHIBLI

	F1	F4	GCTOL	GCTOS	GCTCL	GCTCS
ROS 62X86 F.20	77298521001	77298521004	77298521012	77298521023	77298521024	77298521025
Rosetta 62x86 foro tondo D.20	2,85	2,85	4,40	5,20	4,40	5,20
1 <i>Rose mm 62x86 with hole dia. 20</i>						
ROS 52X72 LIM/AP	77298599001	77298599004	77298599012	77298599023	77298599024	77298599025
Rosetta 52x72 per limitatore di apertura	1,80	1,80	3,30	4,10	3,30	4,10
2 <i>Rose mm. 52x72 for L/A</i>						
BOC 62X86 DM/UNIV	77298626001	77298626004	77298626012	77298626023	77298626024	77298626025
Bocchetta 62x86 doppia mappa universale	2,85	2,85	4,40	5,20	4,40	5,20
3 <i>Escutcheon mm 62x86 for safety lock</i>						
BOC 62X86 DM INT	77298626301	77298626304	77298626312	77298626323	77298626324	77298626325
Bocchetta 62x86 doppia mappa interna	2,85	2,85	4,40	5,20	4,40	5,20
4 <i>Inside escutcheon mm 62x86 for safety lock</i>						
BOC 62X86 DM EST	77298626401	77298626404	77298626412	77298626423	77298626424	77298626425
Bocchetta 62x86 doppia mappa esterna	2,85	2,85	4,40	5,20	4,40	5,20
5 <i>Outside escutcheon mm 62x86 for safety lock</i>						
BOC 62X86 OMEGA	77298625901	77298625904	77298625912	77298625923	77298625924	77298625925
Bocchetta 62x86 OMEGA	2,85	2,85	4,40	5,20	4,40	5,20
6 <i>Outside escutcheon mm 62x86 for OMEGA safety lock</i>						
BOC 62X86 YALE	77298625001	77298625004	77298625012	77298625023	77298625024	77298625025
Bocchetta 62x86 yale	2,85	2,85	4,40	5,20	4,40	5,20
7 <i>Escutcheon mm 62x86 cylinder profile</i>						
BOC 62X86 F10	77298628101	77298628104	77298628112	77298628123	77298628124	77298628125
Bocchetta 62x86 foro D.10 per cilindro con pomolo	2,85	2,85	4,40	5,20	4,40	5,20
8 <i>Escutcheon mm 62x86 for cylinder with knob</i>						
BOC 62X86 DEF42	77298626501	77298626504	77298626512	77298626523	77298626524	77298626525
Bocchetta 62x86 Defender 42	2,85	2,85	4,40	5,20	4,40	5,20
9 <i>Escutcheon mm 62x86 for cylinder protection dia. 42</i>						
BOC 62X86 DEF47	77298626701	77298626704	77298626712	77298626723	77298626724	77298626725
Bocchetta 62x86 Defender 47	2,85	2,85	4,40	5,20	4,40	5,20
9 <i>Escutcheon mm 62x86 for cylinder protection dia. 47</i>						
BOC 62X86 DEF50	77298626601	77298626604	77298626612	77298626623	77298626624	77298626625
Bocchetta 62x86 Defender 50	2,85	2,85	4,40	5,20	4,40	5,20
9 <i>Escutcheon mm 62x86 for cylinder protection dia. 50</i>						

GHIBLI-2

ROS 62X70 F.20	77198521001	77198521004	77198521012	77198521023	77198521024	77198521025
Rosetta 62x70 foro tondo D.20	2,20	2,20	3,40	4,30	3,40	4,30
1 <i>Rose mm 62x70 with hole dia. 20</i>						
ROS 62X70 LIM/AP	77198599001	77198599004	77198599012	77198599023	77198599024	77198599025
Rosetta 62x70 per limitatore di apertura	2,20	2,20	3,40	4,30	3,40	4,30
2 <i>Rose mm. 62x70 for L/A</i>						
BOC 62X70 DM/UNIV	77198626001	77198626004	77198626012	77198626023	77198626024	77198626025
Bocchetta 62x70 doppia mappa universale	2,20	2,20	3,40	4,30	3,40	4,30
3 <i>Escutcheon mm 62x70 for safety lock</i>						
BOC 62X70 YALE	77198625001	77198625004	77198625012	77198625023	77198625024	77198625025
Bocchetta 62x70 yale	2,20	2,20	3,40	4,30	3,40	4,30
4 <i>Escutcheon mm 62x70 cylinder profile</i>						
BOC 62X70 F10	77198628101	77198628104	77198628112	77198628123	77198628124	77198628125
Bocchetta 62x70 foro D.10 per cilindro con pomolo	2,20	2,20	3,40	4,30	3,40	4,30
5 <i>Escutcheon mm 62x70 for cylinder with knob</i>						

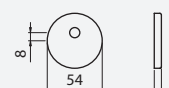
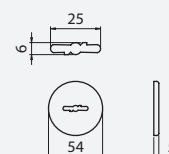
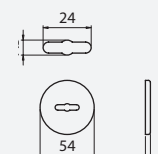
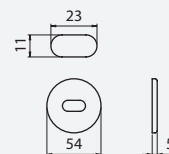
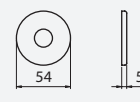

GCTOL

F4

BOCCHETTE

	F4	GCTOL	GCTOS	GCTCL	GCTCS	Conf. pz.
ROS. D54x5 F/18 Rosetta mm 54x5 foro dia. mm.18 <i>Escutcheon mm.54x5 with hole dia. 18</i>	77048501504	77048501512	77048501523	77048501524	77048501525	50
	2,05	4,10	4,70	4,10	4,70	
ROS. D54x5 L/A Rosetta mm 54x5 per limitatore apertura <i>Escutcheon mm.54x5</i>	77048599204	77048599212	77048599223	77048599224	77048599225	50
	2,05	4,10	4,70	4,10	4,70	
BOCC. D54x5 DM UNIV. INT. Bocchetta mm 54x5 doppia mappa universale interna (con copritoppa) <i>Inside escutcheon mm.54x5 for safety lock with cover.</i>	77048637304	77048637312	77048637323	77048637324	77048637325	50
	2,05	4,10	4,70	4,10	4,70	
BOCC. D54x5 DM UNIV. EST. Bocchetta mm 54x5 doppia mappa universale esterna <i>Outside escutcheon mm.54x5 for safety lock</i>	77048637404	77048637412	77048637423	77048637424	77048637425	50
	2,05	4,10	4,70	4,10	4,70	
BOCC. D54x5 DM/5 INT. Bocchetta mm 54x5 doppia mappa tipo 5 (Mottura) interna (con copritoppa) <i>Inside escutcheon mm.54x5 for safety lock nr. 5 Mottura - with cover.</i>	77048637504	77048637512	77048637523	77048637524	77048637525	50
	2,05	4,10	4,70	4,10	4,70	
BOCC. D54x5 DM/5 EST. Bocchetta mm 54x5 doppia mappa tipo 5 (Mottura) esterna <i>Outside escutcheon mm.54x5 for safety lock nr. 5 Mottura -</i>	77048637604	77048637612	77048637623	77048637624	77048637625	50
	2,05	4,10	4,70	4,10	4,70	
BOCC. D54x5 YALE Bocchetta mm 54x5 foro Yale <i>Escutcheon mm.54x5 cyl. yale profile</i>	77048635204	77048635212	77048635223	77048635224	77048635225	50
	2,05	4,10	4,70	4,10	4,70	
ROS. 54x7 F10SP Rosetta mm 54x7 foro dia. mm. 10 spostato <i>Escutcheon mm.54x7 with hole dia. 10</i>	77048540004	77048540012	77048540023	77048540024	77048540025	50
	2,05	4,10	4,70	4,10	4,70	

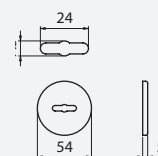
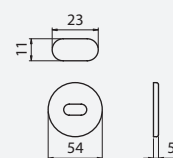
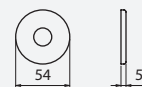

OLV-M1

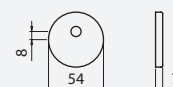
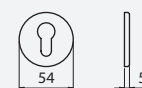
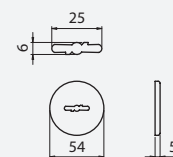

BOCCHETTE

	OLV M1	OCS M18	OGV M27	OCL M4	OS M2	Conf. pz.
ROS. D54x5 F/18 Rosetta mm 54x5 foro dia. mm.18 <i>Escutcheon mm.54x5 with hole dia. 18</i>	55748501501 2,40	55748501503 3,10	55748501504 2,40	55748501507 3,10	55748501508 2,40	50
ROS. D54x5 L/A Rosetta mm 54x5 per limitatore apertura <i>Escutcheon mm.54x5</i>	55748599201 2,40	55748599203 3,10	55748599204 2,40	55748599207 3,10	55748599208 2,40	50
BOCC. D54x5 DM UNIV. INT. Bocchetta mm 54x5 doppia mappa universale interna (con copritoppa) <i>Inside escutcheon mm.54x5 for safety lock with cover.</i>	55748637301 2,40	55748637303 3,10	55748637304 2,40	55748637307 3,10	55748637308 2,40	50
BOCC. D54x5 DM UNIV. EST. Bocchetta mm 54x5 doppia mappa universale esterna <i>Outside escutcheon mm.54x5 for safety lock</i>	55748637401 2,40	55748637403 3,10	55748637404 2,40	55748637407 3,10	55748637408 2,40	50
BOCC. D54x5 DM/5 INT. Bocchetta mm 54x5 doppia mappa tipo 5 (Mottura) interna (con copritoppa) <i>Inside escutcheon mm.54x5 for safety lock nr. 5 Mottura - with cover.</i>	55748637501 2,40	55748637503 3,10	55748637504 2,40	55748637507 3,10	55748637508 2,40	50
BOCC. D54x5 DM/5 EST. Bocchetta mm 54x5 doppia mappa tipo 5 (Mottura) esterna <i>Outside escutcheon mm.54x5 for safety lock nr. 5 Mottura -</i>	55748637601 2,40	55748637603 3,10	55748637604 2,40	55748637607 3,10	55748637608 2,40	50
BOCC. D54x5 YALE Bocchetta mm 54x5 foro Yale <i>Escutcheon mm.54x5 cyl. yale profile</i>	55748635201 2,40	55748635203 3,10	55748635204 2,40	55748635207 3,10	55748635208 2,40	50
ROS. 54x7 F10SP Rosetta mm 54x7 foro dia. mm. 10 spostato <i>Escutcheon mm.54x7 with hole dia. 10</i>	55748540001 2,40	55748540003 3,10	55748540004 2,40	55748540007 3,10	55748540008 2,40	50



GCTOL F4

SUSY

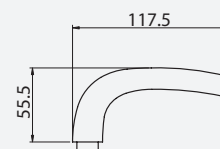

	F1	F4	GCTOL	GCTOS	GCTCL	GCTCS
SUSY IM Q8 GM6TE Maniglia Susy Q8 grano M6 in testa	77434012301	77434012304	77434012312	77434012323	77434012324	77434012325
	4,80	4,80	5,70	7,10	5,70	7,10



GCTOL F4

BRIXIA

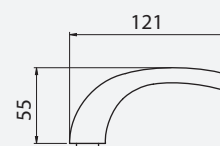

	F1	F4	GCTOL	GCTOS	GCTCL	GCTCS
BRIXIA IM Q8 GM6TE Maniglia Brixia Q8 grano M6 in testa	77438012301	77438012304	77438012312	77438012323	77438012324	77438012325
	5,00	5,00	5,90	7,30	5,90	7,30



GCTOL F4

DAFNE

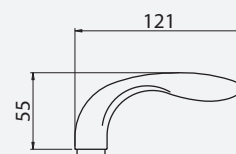

	F1	F4	GCTOL	GCTOS	GCTCL	GCTCS
DAFNE IM Q8 GM6TE Maniglia Dafne Q8 grano M6 in testa	77436012301	77436012304	77436012312	77436012323	77436012324	77436012325
	5,00	5,00	5,90	7,30	5,90	7,30



GCTOL

MEZZALUNA

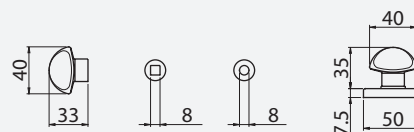

	F1	F4	GCTOL	GCTOS	GCTCL	GCTCS
POM Q8 S/ROS Pomolo Q8 senza rosetta	77048228501	77048228504	77048228512	77048228523	77048228524	77048228525
	2,65	2,65	3,80	5,40	3,80	5,40
POM F.8 S/ROS Pomolo foro mm 8 senza rosetta	77048228701	77048228704	77048228712	77048228723	77048228724	77048228725
	2,65	2,65	3,80	5,40	3,80	5,40
POM Q8 R50x7 Q8x80 Pomolo Q8 rosetta 50x7 ferro Q8x80	7704822850128	7704822850428	7704822851228	7704822852328	7704822852428	7704822852528
	6,20	6,20	7,00	9,10	7,00	9,10

MILENA



OLV-M1

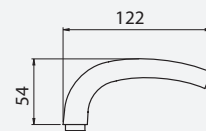

MILENA IM Q8 GM6TE

Maniglia Milena Q8 grano M6 in testa

OLV M1	OCS M18	OGV M27	OCL M4	OS M2
55744012301	55744012303	55744012304	55744012307	55744012308
7,00	7,70	7,00	7,70	7,00

UNO



OLV-M1

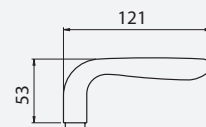

UNO IM Q8 GM6TE

Maniglia Uno Q8 grano M6 in testa

OLV M1	OCS M18	OGV M27	OCL M4	OS M2
55796012301	55796012303	55796012304	55796012307	55796012308
8,20	8,90	8,20	8,90	8,20

GM05



OLV-M1

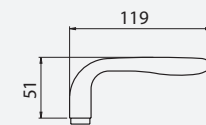

GM05 IM Q8 GM6TE

Maniglia GM05 Q8 grano M6 in testa

OLV M1	OCS M18	OGV M27	OCL M4	OS M2
5GM88012301	5GM88012303	5GM88012304	5GM88012307	5GM88012308
6,30	7,00	6,30	7,00	6,30

MEZZALUNA



OLV-M1

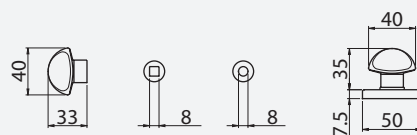

	OLV M1	OCS M18	OGV M27	OCL M4	OS M2
POM Q8 S/ROS Pomolo Q8 senza rosetta	55748228501	55748228503	55748228504	55748228507	55748228508
	5,50	7,80	5,50	7,80	5,50
POM F.8 S/ROS Pomolo foro mm 8 senza rosetta	55748228701	55748228703	55748228704	55748228707	55748228708
	5,50	7,80	5,50	7,80	5,50
POM Q8 R50x7 Q8x80 Pomolo Q8 rosetta 50x7 ferro Q8x80	5574822850128	5574822850328	5574822850428	5574822850728	5574822850828
	8,00	10,40	8,00	10,40	8,00

ERIKA

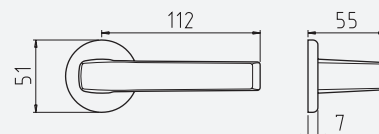

	F4	Conf. pz.
IM Q8 GM6TE R51x7 Maniglia Q8 grano M6 in testa rosetta 51x7 staccata senza ferro	7741038020415	20
	6,60	
IM Q8 GM6TE R51x7 + Q8x65 ESP Maniglia Q8 grano M6 in testa rosetta 51x7 staccata con ferro Q8x65 ad espansione	7741038060415	20
	9,00	
IM Q8 GM6TE R51x7 + Q8x80 ESP Maniglia Q8 grano M6 in testa rosetta 51x7 staccata con ferro Q8x80 ad espansione	7741038080415	20
	9,20	

BRASILIA

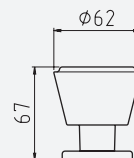

POM D.60 CP R51x7
Pomolo D. 60 centroporta (fisso) rosetta 51x7 staccata

F4	Conf. pz.
77458770504	8
10,30	

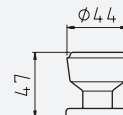

POM D.45 R45x7 Q8x65 ESP
Pomolo D.45 con rosetta 45x7 Q8x65 espansione

F4	Conf. pz.
77460380604	20
7,80	

POM D.45 R45x7 Q8x80 ESP
Pomolo D.45 con rosetta 45x7 Q8x80 espansione

F4	Conf. pz.
77460380804	20
7,90	

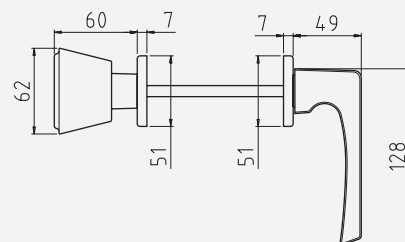
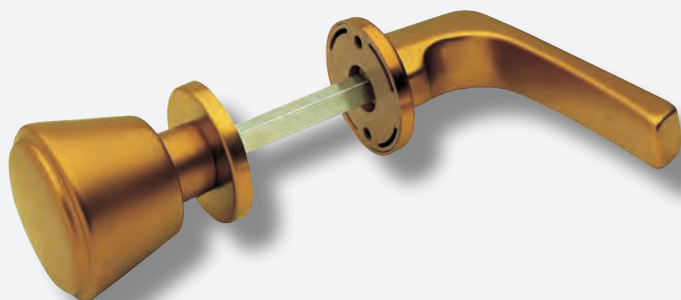

IM GM6TE+POM60 Q8F R51
Maniglia Q8 grano M6 in testa + pomolo fisso rosetta 51x7 staccata

F4
77410977004
19,80

UNIVERSAL



GCTOL

F4

La rosetta nell'immagine
 è solo rappresentativa

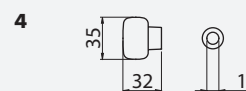
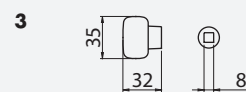
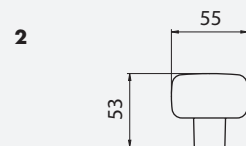
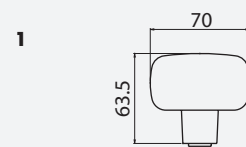

	F1	F4	GCTOL	GCTOS	GCTCL	GCTCS
1 POM70 M10/Q8 S/ROS Pomolo mm 70 fisso/girevole senza rosetta	77486875601	77486875604	77486875612	77486875623	77486875624	77486875625
	10,60	10,60	12,20	15,90	12,20	15,90
2 POM55 M10/Q8 S/ROS Pomolo mm 55 fisso/girevole senza rosetta	77486855601	77486855604	77486855612	77486855623	77486855624	77486855625
	8,20	8,20	9,60	12,50	9,60	12,50
3 POM35 Q8 S/ROS Pomolo mm 35 Q8 senza rosetta	77486812701	77486812704	77486812712	77486812723	77486812724	77486812725
	4,00	4,00	5,30	6,80	5,30	6,80
4 POM35 F.10 S/ROS Pomolo mm 35 foro mm 10 senza rosetta	77486817301	77486817304	77486817312	77486817323	77486817324	77486817325
	4,00	4,00	5,30	6,80	5,30	6,80

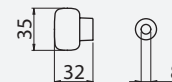

POM35 F.8 S/ROS Pomolo mm 35 foro mm 8 senza rosetta	77486816701	77486816704	77486816712	77486816723	77486816724	77486816725
	4,00	4,00	5,30	6,80	5,30	6,80

SUSY



GCTOL



F4

La rosetta nell'immagine
 è solo rappresentativa

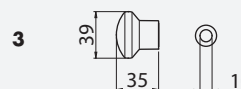
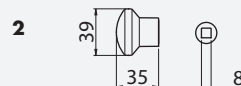
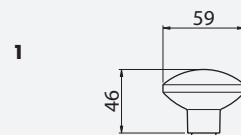

		F1	F4	GCTOL	GCTOS	GCTCL	GCTCS
1	POM60 M10/Q8 S/ROS	77434865601	77434865604	77434865612	77434865623	77434865624	77434865625
	Pomolo mm 60 fisso/girevole senza rosetta	8,20	8,20	9,60	12,50	9,60	12,50
2	POM40 Q8 S/ROS *	77434822701	77434822704	77434822712	77434822723	77434822724	77434822725
	Pomolo mm 40 Q8 senza rosetta	4,50	4,50	5,80	7,40	5,80	7,40
3	POM40 F.10 S/ROS *	77434827301	77434827304	77434827312	77434827323	77434827324	77434827325
	Pomolo mm 40 foro mm 10 senza rosetta	4,50	4,50	5,80	7,40	5,80	7,40

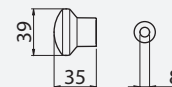

4	POM40 F.8 S/ROS *	77434816701	77434816704	77434816712	77434816723	77434816724	77434816725
	Pomolo mm 40 foro mm 8 senza rosetta	4,50	4,50	5,80	7,40	5,80	7,40

* Abbinabile anche alla
 Serie PEGASO

PEGASO



GCTOL



F4

La rosetta nell'immagine
 è solo rappresentativa

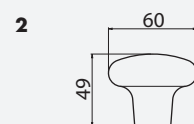
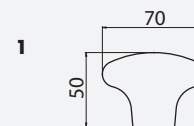

		F1	F4	GCTOL	GCTOS	GCTCL	GCTCS
1	POM70 M10/Q8 S/ROS	70143875601	70143875604	70143875612	70143875623	70143875624	70143875625
	Pomolo mm 70 fisso/girevole senza rosetta	10,60	10,60	12,20	15,90	12,20	15,90
2	POM60 M10/Q8 S/ROS	70143865601	70143865604	70143865612	70143865623	70143865624	70143865625
	Pomolo mm 60 fisso/girevole senza rosetta	8,20	8,20	9,60	12,50	9,60	12,50

BLINDO



GCTOL



F4

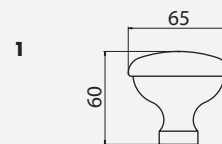

La rosetta nell'immagine
 è solo rappresentativa

	F1	F4	GCTOL	GCTOS	GCTCL	GCTCS
1 POM65 M10/Q8 S/ROS	77194875601	77194875604	77194875612	77194875623	77194875624	77194875625
Pomolo mm 65 fisso/girevole senza rosetta	8,20	8,20	9,60	12,50	9,60	12,50

MILENA



OLV-M1

La rosetta nell'immagine
 è solo rappresentativa

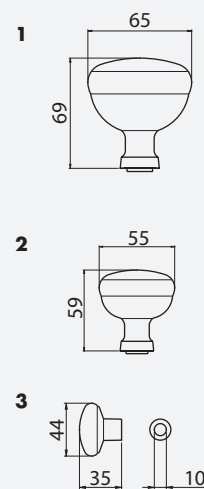

	OLV M1	OCS M18	OGV M27	OCL M4	OS M2
1	POM70 M10/Q8 S/ROS				
	Pomolo mm 70 fisso/girevole senza rosetta	55744875601	55744875603	55744875604	55744875607
		23,20	29,20	23,20	29,20
2	POM55 M10/Q8 S/ROS				
	Pomolo mm 55 fisso/girevole senza rosetta	55744855601	55744855603	55744855604	55744855607
		19,10	23,40	19,10	23,40
3	POM45 F.10 S/ROS				
	Pomolo mm 45 foro mm 10 senza rosetta	55744837301	55744837303	55744837304	55744837307
		10,90	12,00	10,90	12,00

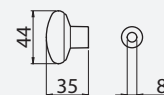

POM45 F.8 S/ROS					
Pomolo mm 45 foro mm 8 senza rosetta	55744836701	55744836703	55744836704	55744836707	55744836708
	10,90	12,00	10,90	12,00	10,90

PEGASO



OLV-M1

La rosetta nell'immagine
 è solo rappresentativa

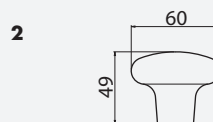
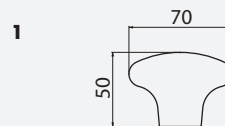

	OLV M1	OCS M18	OGV M27	OCL M4	OS M2	
1	POM70 M10/Q8 S/ROS					
	Pomolo mm 70 fisso/girevole senza rosetta	44890875601	44890875603	44890875604	44890875607	44890875608
		19,80	25,80	21,80	25,80	21,80
2	POM60 M10/Q8 S/ROS					
	Pomolo mm 60 fisso/girevole senza rosetta	44890865601	44890865603	44890865604	44890865607	44890865608
		18,50	24,50	20,50	24,50	20,50

BLINDO



OLV-M1

La rosetta nell'immagine
 è solo rappresentativa

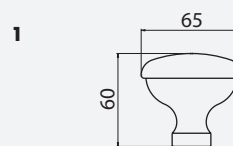

	OLV M1	OCS M18	OGV M27	OCL M4	OS M2	
1	POM65 M10/Q8 S/ROS					
	Pomolo mm 65 fisso/girevole senza rosetta	55694875601	55694875603	55694875604	55694875607	55694875608
		18,50	24,50	20,50	24,50	20,50



COORDINATI PER PORTE DA HOTEL *ACCESSORIES FOR HOTEL DOORS*

■ GUARNITURA MANIGLIA + POMOLO PLACCA 248x55	542-547
■ GUARNITURA MANIGLIA + POMOLO PLACCA 242x38	543
■ GUARNITURA MANIGLIA + POMOLO PLACCA 220x60	544
■ GUARNITURA MANIGLIA + POMOLO PLACCA 220x60 CON INDICATORE PER SERRATURA CISA	545
■ GUARNITURA MANIGLIA + POMOLO ROSETTA/BOCCHETTA 50x7	546
■ GUARNITURA MANIGLIA AMERICA + POMOLO UNIVERSAL PLACCA 180x54	548



Maniglia
destra.

OLV-M1

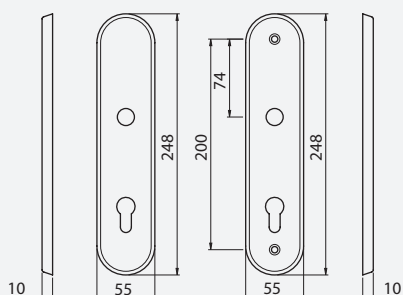

GUARNITURA HOTEL MANIGLIA DX + POMOLO FISSO SU PLACCA 248X55 YALE 85

	Maniglia Dx MARZIA	Maniglia Dx MILENA	Maniglia Dx UNO	Maniglia Dx GM05
OLV-M1				
Pomolo Sfera	55424901101 46,20	55744901101 44,70	55796901101 45,60	5GM88901101 42,50
Pomolo Milena	55424902101 44,10	55744902101 42,60	55796902101 43,50	5GM88902101 40,40
Pomolo Pegaso	55424903101 44,10	55744903101 42,60	55796903101 43,50	5GM88903101 40,40
OCS-M18				
Pomolo Sfera	55424901103 60,10	55744901103 58,50	55796901103 59,40	5GM88901103 56,40
Pomolo Milena	55424902103 58,00	55744902103 56,40	55796902103 57,30	5GM88902103 54,30
Pomolo Pegaso	55424903103 58,00	55744903103 56,40	55796903103 57,30	5GM88903103 54,30
OCL-M4				
Pomolo Sfera	55424901107 60,10	55744901107 58,50	55796901107 59,40	5GM88901107 56,40
Pomolo Milena	55424902107 58,00	55744902107 56,40	55796902107 57,30	5GM88902107 54,30
Pomolo Pegaso	55424903107 58,00	55744903107 56,40	55796903107 57,30	5GM88903107 54,30

GUARNITURA HOTEL MANIGLIA SX + POMOLO FISSO SU PLACCA 248X55 YALE 85

	Maniglia Sx MARZIA	Maniglia Sx MILENA	Maniglia Sx UNO	Maniglia Sx GM05
OLV-M1				
Pomolo Sfera	55424911101 46,20	55744911101 44,70	55796911101 45,60	5GM88911101 42,50
Pomolo Milena	55424912101 44,10	55744912101 42,60	55796912101 43,50	5GM88912101 40,40
Pomolo Pegaso	55424913101 44,10	55744913101 42,60	55796913101 43,50	5GM88913101 40,40
OCS-M18				
Pomolo Sfera	55424911103 60,10	55744911103 58,50	55796911103 59,40	5GM88911103 56,40
Pomolo Milena	55424912103 58,00	55744912103 56,40	55796912103 57,30	5GM88912103 54,30
Pomolo Pegaso	55424913103 58,00	55744913103 56,40	55796913103 57,30	5GM88913103 54,30
OCL-M4				
Pomolo Sfera	55424911107 60,10	55744911107 58,50	55796911107 59,40	5GM88911107 56,40
Pomolo Milena	55424912107 58,00	55744912107 56,40	55796912107 57,30	5GM88912107 54,30
Pomolo Pegaso	55424913107 58,00	55744913107 56,40	55796913107 57,30	5GM88913107 54,30

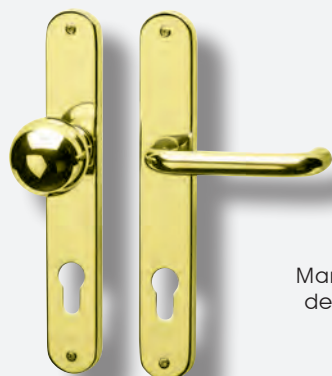

Maniglia destra.

OLV-M1

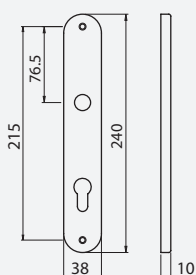

GUARNITURA HOTEL MANIGLIA DX + POMOLO FISSO SU PLACCA 242X38 YALE 85

	Maniglia Dx MARZIA	Maniglia Dx MILENA	Maniglia Dx UNO	Maniglia Dx GM05
OLV-M1				
Pomolo Sfera	55424901201 35,20	55744901201 33,70	55796901201 34,60	5GM88901201 31,60
Pomolo Milena	55424902201 33,10	55744902201 31,60	55796902201 32,50	5GM88902201 29,50
Pomolo Pegaso	55424903201 33,10	55744903201 31,60	55796903201 32,50	5GM88903201 29,50
OCS-M18				
Pomolo Sfera	55424901203 49,10	55744901203 47,60	55796901203 48,50	5GM88901203 45,40
Pomolo Milena	55424902203 47,00	55744902203 45,50	55796902203 46,40	5GM88902203 43,30
Pomolo Pegaso	55424903203 47,00	55744903203 45,50	55796903203 46,40	5GM88903203 43,30
OCL-M4				
Pomolo Sfera	55424901207 49,10	55744901207 47,60	55796901207 48,50	5GM88901207 45,40
Pomolo Milena	55424902207 47,00	55744902207 45,50	55796902207 46,40	5GM88902207 43,30
Pomolo Pegaso	55424903207 47,00	55744903207 45,50	55796903207 46,40	5GM88903207 43,30

GUARNITURA HOTEL MANIGLIA SX + POMOLO FISSO SU PLACCA 242X38 YALE 85

	Maniglia Sx MARZIA	Maniglia Sx MILENA	Maniglia Sx UNO	Maniglia Sx GM05
OLV-M1				
Pomolo Sfera	55424911201 35,20	55744911201 33,70	55796911201 34,60	5GM88911201 31,60
Pomolo Milena	55424912201 33,10	55744912201 31,60	55796912201 32,50	5GM88912201 29,50
Pomolo Pegaso	55424913201 33,10	55744913201 31,60	55796913201 32,50	5GM88913201 29,50
OCS-M18				
Pomolo Sfera	55424911203 49,10	55744911203 47,60	55796911203 48,50	5GM88911203 45,40
Pomolo Milena	55424912203 47,00	55744912203 45,50	55796912203 46,40	5GM88912203 43,30
Pomolo Pegaso	55424913203 47,00	55744913203 45,50	55796913203 46,40	5GM88913203 43,30
OCL-M4				
Pomolo Sfera	55424911207 49,10	55744911207 47,60	55796911207 48,50	5GM88911207 45,40
Pomolo Milena	55424912207 47,00	55744912207 45,50	55796912207 46,40	5GM88912207 43,30
Pomolo Pegaso	55424913207 47,00	55744913207 45,50	55796913207 46,40	5GM88913207 43,30



Maniglia destra.

OLV-M1

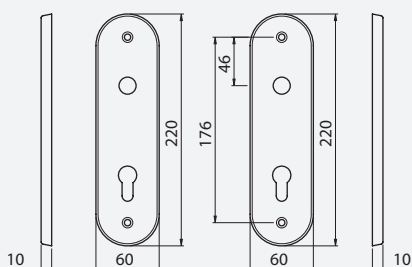

GUARNITURA HOTEL MANIGLIA DX + POMOLO FISSO SU PLACCA 220X60 YALE 85

OLV-M1	Maniglia Dx MARZIA	Maniglia Dx MILENA	Maniglia Dx UNO	Maniglia Dx GM05
Pomolo Sfera	55424901301 54,60	55744901301 53,10	55796901301 54,00	5GM88901301 50,90
Pomolo Milena	55424902301 52,50	55744902301 51,00	55796902301 51,90	5GM88902301 48,80
Pomolo Pegaso	55424903301 52,50	55744903301 51,00	55796903301 51,90	5GM88903301 48,80
OCS-M18				
Pomolo Sfera	55424901303 68,50	55744901303 66,90	55796901303 67,80	5GM88901303 64,80
Pomolo Milena	55424902303 66,40	55744902303 64,80	55796902303 65,70	5GM88902303 62,70
Pomolo Pegaso	55424903303 66,40	55744903303 64,80	55796903303 65,70	5GM88903303 62,70
OCL-M4				
Pomolo Sfera	55424901307 68,50	55744901307 66,90	55796901307 67,80	5GM88901307 64,80
Pomolo Milena	55424902307 66,40	55744902307 64,80	55796902307 65,70	5GM88902307 62,70
Pomolo Pegaso	55424903307 66,40	55744903307 64,80	55796903307 65,70	5GM88903307 62,70

GUARNITURA HOTEL MANIGLIA SX + POMOLO FISSO SU PLACCA 220X60 YALE 85

OLV-M1	Maniglia Sx MARZIA	Maniglia Sx MILENA	Maniglia Sx UNO	Maniglia Sx GM05
Pomolo Sfera	55424911301 54,60	55744911301 53,10	55796911301 54,00	5GM88911301 50,90
Pomolo Milena	55424912301 52,50	55744912301 51,00	55796912301 51,90	5GM88912301 48,80
Pomolo Pegaso	55424913301 52,50	55744913301 51,00	55796913301 51,90	5GM88913301 48,80
OCS-M18				
Pomolo Sfera	55424911303 68,50	55744911303 66,90	55796911303 67,80	5GM88911303 64,80
Pomolo Milena	55424912303 66,40	55744912303 64,80	55796912303 65,70	5GM88912303 62,70
Pomolo Pegaso	55424913303 66,40	55744913303 64,80	55796913303 65,70	5GM88913303 62,70
OCL-M4				
Pomolo Sfera	55424911307 68,50	55744911307 66,90	55796911307 67,80	5GM88911307 64,80
Pomolo Milena	55424912307 66,40	55744912307 64,80	55796912307 65,70	5GM88912307 62,70
Pomolo Pegaso	55424913307 66,40	55744913307 64,80	55796913307 65,70	5GM88913307 62,70

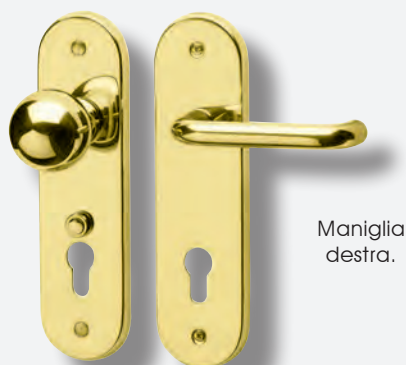

Maniglia
destra.

OLV-M1

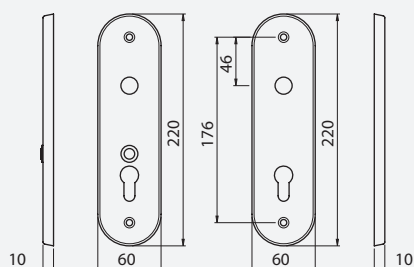

GUARNITURA HOTEL MANIGLIA DX + POMOLO FISSO SU PLACCA 220X60 YALE 85 IND/CISA

OLV-M1	Maniglia Dx MARZIA	Maniglia Dx MILENA	Maniglia Dx UNO	Maniglia Dx GM05
Pomolo Sfera	55424901401 63,80	55744901401 62,30	55796901401 63,20	5GM88901401 60,10
Pomolo Milena	55424902401 61,70	55744902401 60,20	55796902401 61,10	5GM88902401 58,00
Pomolo Pegaso	55424903401 61,70	55744903401 60,20	55796903401 61,10	5GM88903401 58,00
OCS-M18				
Pomolo Sfera	55424901403 77,60	55744901403 76,10	55796901403 75,20	5GM88901403 74,00
Pomolo Milena	55424902403 75,50	55744902403 74,00	55796902403 73,10	5GM88902403 71,90
Pomolo Pegaso	55424903403 75,50	55744903403 74,00	55796903403 73,10	5GM88903403 71,90
OCL-M4				
Pomolo Sfera	55424901407 77,60	55744901407 76,10	55796901407 75,20	5GM88901407 74,00
Pomolo Milena	55424902407 75,50	55744902407 74,00	55796902407 73,10	5GM88902407 71,90
Pomolo Pegaso	55424903407 75,50	55744903407 74,00	55796903407 73,10	5GM88903407 71,90

GUARNITURA HOTEL MANIGLIA SX + POMOLO FISSO SU PLACCA 220X60 YALE 85 IND/CISA

OLV-M1	Maniglia Sx MARZIA	Maniglia Sx MILENA	Maniglia Sx UNO	Maniglia Sx GM05
Pomolo Sfera	55424911401 63,80	55744911401 62,30	55796911401 63,20	5GM88911401 60,10
Pomolo Milena	55424912401 61,70	55744912401 60,20	55796912401 61,10	5GM88912401 58,00
Pomolo Pegaso	55424913401 61,70	55744913401 60,20	55796913401 61,10	5GM88913401 58,00
OCS-M18				
Pomolo Sfera	55424911403 77,60	55744911403 76,10	55796911403 75,20	5GM88911403 74,00
Pomolo Milena	55424912403 75,50	55744912403 74,00	55796912403 73,10	5GM88912403 71,90
Pomolo Pegaso	55424913403 75,50	55744913403 74,00	55796913403 73,10	5GM88913403 71,90
OCL-M4				
Pomolo Sfera	55424911407 77,60	55744911407 76,10	55796911407 75,20	5GM88911407 74,00
Pomolo Milena	55424912407 75,50	55744912407 74,00	55796912407 73,10	5GM88912407 71,90
Pomolo Pegaso	55424913407 75,50	55744913407 74,00	55796913407 73,10	5GM88913407 71,90



Maniglia
destra.

OLV-M1

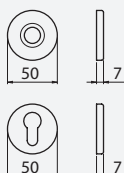

GUARNITURA HOTEL MANIGLIA DX + POMOLO FISSO SU ROS/BOCC 50X7

OLV-M1	Maniglia Dx MARZIA	Maniglia Dx MILENA	Maniglia Dx UNO	Maniglia Dx GM05
Pomolo Sfera	55424901901 32,20	55744901901 30,70	55796901901 31,60	5GM88901901 28,50
Pomolo Milena	55424902901 30,10	55744902901 28,60	55796902901 29,50	5GM88902901 26,40
Pomolo Pegaso	55424903901 30,10	55744903901 28,60	55796903901 29,50	5GM88903901 26,40
OCS-M18				
Pomolo Sfera	55424901903 46,00	55744901903 44,50	55796901903 45,40	5GM88901903 42,40
Pomolo Milena	55424902903 43,90	55744902903 42,40	55796902903 43,30	5GM88902903 40,30
Pomolo Pegaso	55424903903 43,90	55744903903 42,40	55796903903 43,30	5GM88903903 40,30
OCL-M4				
Pomolo Sfera	55424901907 46,00	55744901907 44,50	55796901907 45,40	5GM88901907 42,40
Pomolo Milena	55424902907 43,90	55744902907 42,40	55796902907 43,30	5GM88902907 40,30
Pomolo Pegaso	55424903907 43,90	55744903907 42,40	55796903907 43,30	5GM88903907 40,30

GUARNITURA HOTEL MANIGLIA SX + POMOLO FISSO SU ROS/BOCC 50X7

OLV-M1	Maniglia Sx MARZIA	Maniglia Sx MILENA	Maniglia Sx UNO	Maniglia Sx GM05
Pomolo Sfera	55424911901 32,20	55744911901 30,70	55796911901 31,60	5GM88911901 28,50
Pomolo Milena	55424912901 30,10	55744912901 28,60	55796912901 29,50	5GM88912901 26,40
Pomolo Pegaso	55424913901 30,10	55744913901 28,60	55796913901 29,50	5GM88913901 26,40
OCS-M18				
Pomolo Sfera	55424911903 46,00	55744911903 44,50	55796911903 45,40	5GM88911903 42,40
Pomolo Milena	55424912903 43,90	55744912903 42,40	55796912903 43,30	5GM88912903 40,30
Pomolo Pegaso	55424913903 43,90	55744913903 42,40	55796913903 43,30	5GM88913903 40,30
OCL-M4				
Pomolo Sfera	55424911907 46,00	55744911907 44,50	55796911907 45,40	5GM88911907 42,40
Pomolo Milena	55424912907 43,90	55744912907 42,40	55796912907 43,30	5GM88912907 40,30
Pomolo Pegaso	55424913907 43,90	55744913907 42,40	55796913907 43,30	5GM88913907 40,30



Maniglia
destra.

OLV-M1

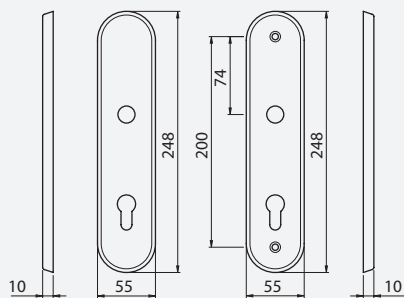

GUARNITURA HOTEL MANIGLIA DX + POMOLO FISSO SU PLACCA 248X55 YALE 85

	Maniglia Dx NOVECENTO	Maniglia Dx ARIANNA
OBR-M45		
Pomolo Arianna	55196904100	55640904100
	55,20	55,20
Pomolo Margherita	55196905100	55640905100
	55,20	55,20
OLV-M1		
Pomolo Arianna	55196904101	55640904101
	55,20	55,20
Pomolo Margherita	55196905101	55640905101
	55,20	55,20

GUARNITURA HOTEL MANIGLIA SX + POMOLO FISSO SU PLACCA 248X55 YALE 85

	Maniglia Sx NOVECENTO	Maniglia Sx ARIANNA
OBR-M45		
Pomolo Arianna	55196914100	55640914100
	55,20	55,20
Pomolo Margherita	55196915100	55640915100
	55,20	55,20
OLV-M1		
Pomolo Arianna	55196914101	55640914101
	55,20	55,20
Pomolo Margherita	55196915101	55640915101
	55,20	55,20



GUARNITURA HOTEL MANIGLIA AMERICA + POMOLO UNIVERSAL FISSO SU PLACCA 180X54 YALE 85



Maniglia
destra.

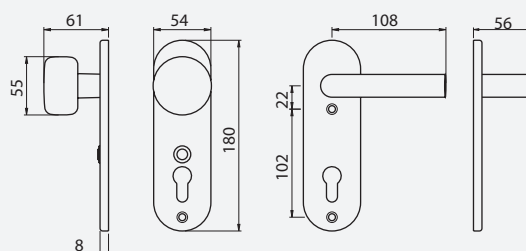

Placca tipo C.

GCTOL

	F1	F3	F4	Conf. pz.
IM PYL85 + PF PY85L/C Maniglia pl yale 85 larga + pom fis pl yale 85 larga tipo C <i>Lever handle + fixed knob on plate-cyl. Key hole at 85 mm.</i>	77444989501 37,10	77444989503 37,10	77444989504 37,10	1
IM PYL85 + PF PY85L Maniglia pl yale 85 larga + pom fis pl yale 85 larga <i>Lever handle + fixed knob on plate-cyl. Key hole at 85 mm.</i>	77444988501 30,20	77444988503 30,20	77444988504 30,20	1

	GCTOL	GCTOS	GCTCL	GCTCS	Conf. pz.
IM PYL85 + PF PY85L/C Maniglia pl yale 85 larga + pom fis pl yale 85 larga tipo C <i>Lever handle + fixed knob on plate-cyl. Key hole at 85 mm.</i>	77444989512 46,50	77444989523 60,40	77444989524 46,50	77444989525 60,40	1
IM PYL85 + PF PY85L Maniglia pl yale 85 larga + pom fis pl yale 85 larga <i>Lever handle + fixed knob on plate-cyl. Key hole at 85 mm.</i>	77444988512 39,70	77444988523 51,60	77444988524 39,70	77444988525 51,60	1

ACCESSORI PER INFISSI ESTERNI *WINDOWS ACCESSORIES EQUIPMENT*

ARSENIO	553
OMETTI FERRO <i>IRON SHUTTER STOP</i>	554-561
OMETTI NYLON <i>NYLON SHUTTER STOP</i>	562
PRATICO	552
SPAGNOLETTE	550

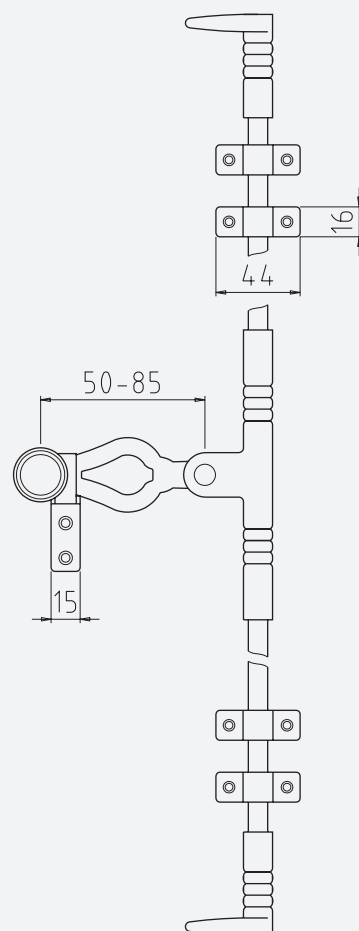
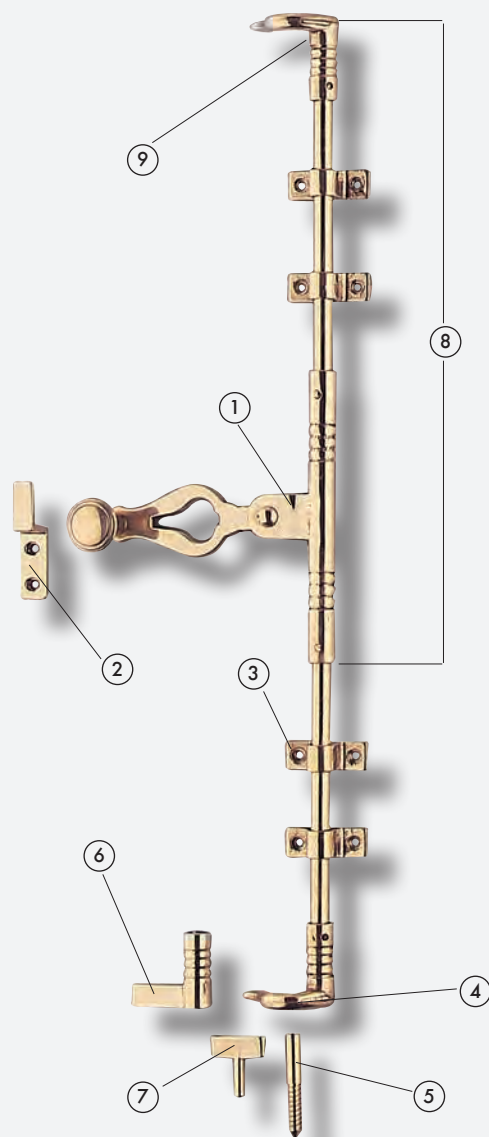

La fotografia riporta una spagnoletta destra con estremità a gancio serie 9127. A seconda della versione necessaria inserire i seguenti codici serie nella posizione in bianco

VERSIONE PER SPAGNOLETTA COMPLETA

Serie	Spagnoletta	Estremità		Maniglia
		Sopra	Sotto	
9127	DESTRA	GANCIO	GANCIO	GRANDE
9126	SINISTRA	GANCIO	GANCIO	GRANDE
9125	DESTRA	GANCIO	PALETTA	GRANDE
9124	SINISTRA	GANCIO	PALETTA	GRANDE
9117	DESTRA	GANCIO	GANCIO	PICCOLA
9116	SINISTRA	GANCIO	GANCIO	PICCOLA
9115	DESTRA	GANCIO	PALETTA	PICCOLA
9114	SINISTRA	GANCIO	PALETTA	PICCOLA

VERSIONE PER SPAGNOLETTA PARTE SUPERIORE

Serie	Spagnoletta	Estremità		Maniglia
		Sopra	Sotto	
9128	DESTRA	GANCIO	PIRAMIDE	GRANDE
9129	SINISTRA	GANCIO	PIRAMIDE	GRANDE
9130	DESTRA	GANCIO	PIRAMIDE	PICCOLA
9131	SINISTRA	GANCIO	PIRAMIDE	PICCOLA

	OBR - M45	OL - M23
SPAGNOLET CM120 Spagnoletta da cm. 101 a cm 120 completa <i>Window handle 'espagnolettes' with bars - complete</i>	4 120000 44,40	4 120001 41,00
SPAGNOLET CM140 Spagnoletta da cm. 121 a cm 140 completa <i>Window handle 'espagnolettes' with bars - complete</i>	4 140000 47,80	4 140001 44,40
SPAGNOLET CM160 Spagnoletta da cm. 141 a cm 160 completa <i>Window handle 'espagnolettes' with bars - complete</i>	4 160000 51,20	4 160001 47,80
SPAGNOLET CM180 Spagnoletta da cm. 161 a cm 180 completa <i>Window handle 'espagnolettes' with bars - complete</i>	4 180000 54,70	4 180001 51,20
SPAGNOLET CM200 Spagnoletta da cm. 181 a cm 200 completa <i>Window handle 'espagnolettes' with bars - complete</i>	4 200000 58,10	4 200001 54,70
SPAGNOLET CM220 Spagnoletta da cm. 201 a cm 220 completa <i>Window handle 'espagnolettes' with bars - complete</i>	4 220000 61,50	4 220001 58,10
SPAGNOLET CM240 Spagnoletta da cm. 221 a cm 240 completa <i>Window handle 'espagnolettes' with bars - complete</i>	4 240000 64,90	4 240001 61,50
SPAGNOLET CM260 Spagnoletta da cm. 241 a cm 260 completa <i>Window handle 'espagnolettes' with bars - complete</i>	4 260000 68,40	4 260001 64,90
8 SPAGNOLET CM120 PARTE SUP Spagnoletta da cm. 101 a cm 120 parte superiore con piramide <i>Window handle 'espagnolettes' with bars - complete</i>	4 120000 44,40	4 120001 41,00
8 SPAGNOLET CM140 PARTE SUP Spagnoletta da cm. 121 a cm 140 parte superiore con piramide <i>Window handle 'espagnolettes' with bars - complete</i>	4 140000 47,80	4 140001 44,40
8 SPAGNOLET CM160 PARTE SUP Spagnoletta da cm. 141 a cm 160 parte superiore con piramide <i>Window handle 'espagnolettes' with bars - complete</i>	4 160000 51,20	4 160001 47,80
ASTA PER SPAG CM160 Solo asta per spagnoletta cm 160 <i>Bar cm. 160</i>	49027160000 27,40	49027160001 27,40
ASTA PER SPAG CM240 Solo asta per spagnoletta cm 240 <i>Bar cm. 240</i>	49027240000 41,00	49027240001 41,00
1 MANIGLIA GRAN SPAG Centrale con maniglia grande (85 mm.) per spagnoletta <i>Main handle</i>	49027900000 12,30	49027900001 12,30
1 MANIGLIA PICC SPAG Centrale con maniglia piccola (50 mm.) per spagnoletta <i>Small handle</i>	49027901000 12,30	49027901001 12,30
2 INCONTRO CENT SPAGN Incontro centrale per spagnoletta <i>Central hook</i>	49027910000 1,75	49027910001 1,75
9 GANCIO SPAG DX Estremità a gancio destro per spagnoletta <i>Terminale hook right</i>	49027920000 2,40	49027920001 2,40
4 GANCIO SPAG SX Estremità a gancio sinistro per spagnoletta <i>Terminale hook left</i>	49027920100 2,40	49027920101 2,40
6 GANCIO PALET SPAG Estremità a paletta per spagnoletta <i>Terminale hook</i>	49027921000 2,40	49027921001 2,40
5 INCONTRO GANC SPAGN Incontro per estremità a gancio <i>Fitting for bar</i>	49027930000 2,40	49027930001 2,40
7 INCONTRO GANC PALET Incontro per estremità a paletta <i>Fitting for bar</i>	49027931000 2,40	49027931001 2,40
3 PASSANTE SPAG Passante per asta spagnoletta <i>Fitting for bar</i>	49027940000 1,40	49027940001 1,40
CHIODINO MM4 SPAG Chiodino mm 4 per spagnoletta <i>Nail mm.4</i>	15455110011 0,30	

PRATICO

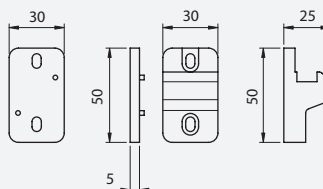
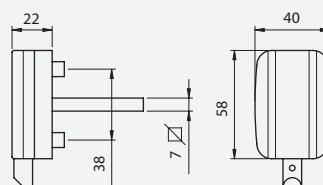
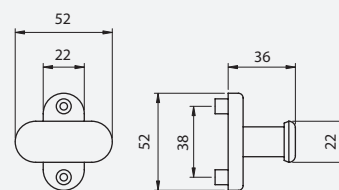
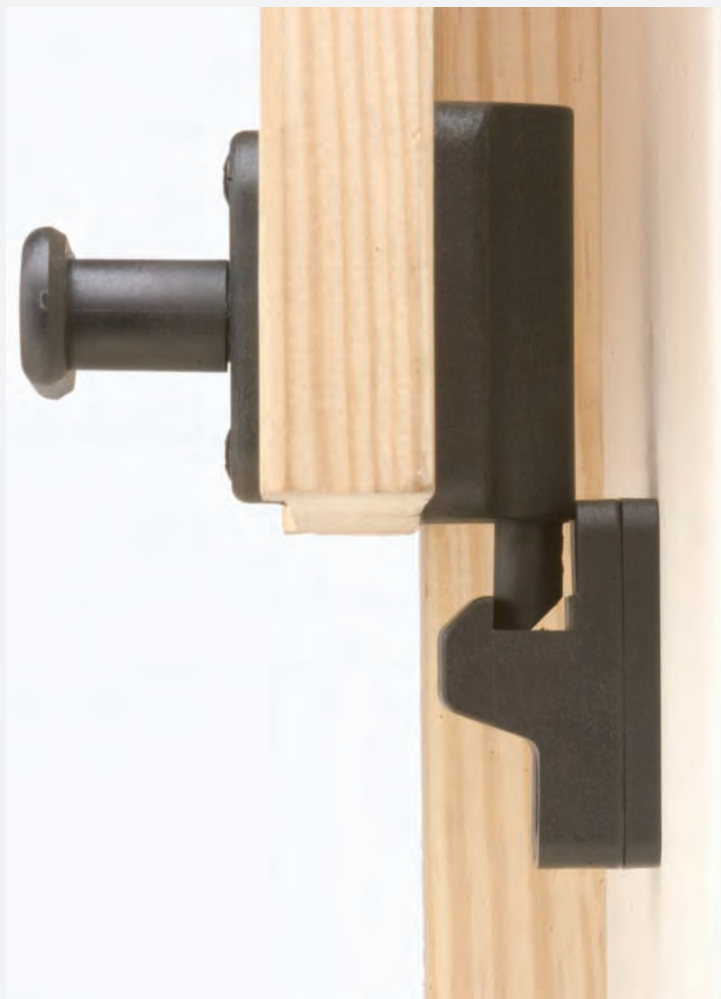

FERMA PERSIANE
Fermo per persiane semi-automatico
Semiautomatic shutter stop

	Conf. pz.
NNE	
89300100005	
8,10	10



ARSENIO

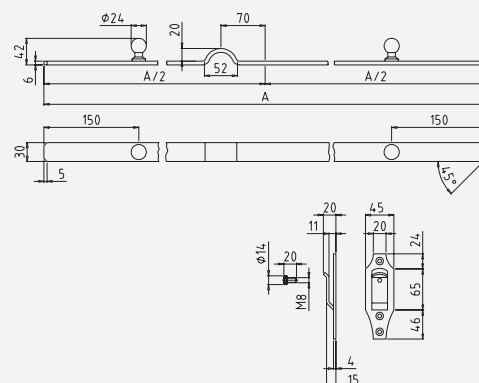

	ZT+N	Conf. pz.
ASTA DI SICUREZZA CM. 60	33182060007	
<i>Safety bar</i>	21,50	10
ASTA DI SICUREZZA CM. 70	33182070007	
<i>Safety bar</i>	21,50	10
ASTA DI SICUREZZA CM. 80	33182080007	
<i>Safety bar</i>	21,50	10
ASTA DI SICUREZZA CM. 90	33182090007	
<i>Safety bar</i>	21,50	10
ASTA DI SICUREZZA CM. 100	33182100007	
<i>Safety bar</i>	22,90	10
ASTA DI SICUREZZA CM. 110	33182110007	
<i>Safety bar</i>	22,90	10
ASTA DI SICUREZZA CM. 120	33182120007	
<i>Safety bar</i>	22,90	10
ASTA DI SICUREZZA CM. 140	33182140007	
<i>Safety bar</i>	23,90	10

	ZT+N	Conf. pz.
ASTA DI SICUREZZA CM. 60 C/INC	33180060007	
<i>Safety bar</i>	32,80	10
ASTA DI SICUREZZA CM. 70 C/INC	33180070007	
<i>Safety bar</i>	32,80	10
ASTA DI SICUREZZA CM. 80 C/INC	33180080007	
<i>Safety bar</i>	32,80	10
ASTA DI SICUREZZA CM. 90 C/INC	33180090007	
<i>Safety bar</i>	32,80	10
ASTA DI SICUREZZA CM. 100 C/INC	33180100007	
<i>Safety bar</i>	34,20	10
ASTA DI SICUREZZA CM. 110 C/INC	33180110007	
<i>Safety bar</i>	34,20	10
ASTA DI SICUREZZA CM. 120 C/INC	33180120007	
<i>Safety bar</i>	34,20	10
ASTA DI SICUREZZA CM. 140 C/INC	33180140007	
<i>Safety bar</i>	35,20	10



	ZT+N	Conf. pz.
INCONTRO CON CHIUSURA	33184500007	
<i>Safety hook</i>	5,70	20

	ZT+N	Conf. pz.
RIALZO PER INCONTRO	33184800007	
	5,70	20

OMETTO SENZA VITE

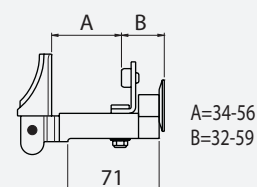

	FZT+N	Conf. pz.
OMETTO BIG S/VITE 2RG Ometto BIG senza vite con 2 regolazioni	33032490107 6,50	20
	FE/ZB	Conf. pz.
KIT 001 1 vite autofil. TE8x250 1 Tass Nylon 10x200	19004800170 4,10	20
KIT 002 1 vite autofil. TE8x180 1 Tass Nylon 10x135	19004800270 2,05	20
KIT 003 1 vite autofil. TE8x100 1 Tass Nylon 12x70	19004800370 2,05	20

PROTEZIONE IN PVC PER TESTA ALTA



	PVC NERO
PROTEZIONE PER TESTA ALTA	18409110005 0,40

OMETTI

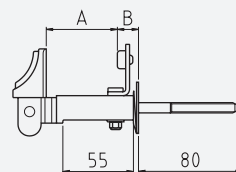

A=32-62
 B=20-55

	FZT	FZT+N	Conf. pz.
OMETTO BIG VITE 2RG Ometto BIG con vite 2 regolazioni <i>Shutter stop</i>	33030290006	33032290007	20
	5,90	4,80	
OMETTO BIG VITE 2RG TESTA ALTA Ometto BIG con vite 2 regolazioni testa alta <i>Shutter stop</i>	33030290106	33032290107	20
	6,30	4,90	

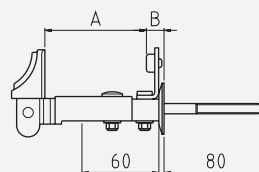

A=70-105
 B=20-45

	FZT	FZT+N	Conf. pz.
OMETTO BIG VITE 2RG SP. ANTA 70 Ometto BIG con vite 2 regolazioni spessore anta mm 70 <i>Shutter stop</i>	33030291006	33032291007	20
	5,90	4,80	
OMETTO BIG VITE 2RG SP. ANTA 70 TESTA ALTA Ometto BIG con vite 2 regolazioni sp. anta mm 70 testa alta <i>Shutter stop</i>	33030291106	33032291107	20
	6,30	4,90	

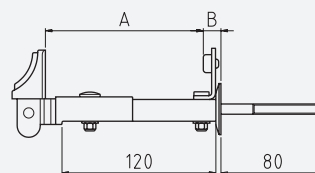

A=70-160
 B=20-105

	FZT	FZT+N	Conf. pz.
OMETTO BIG VITE 2RG DOPPIO Ometto BIG con vite 2 regolazioni doppio <i>Shutter stop</i>	33030295006	33032295007	15
	6,50	5,50	
OMETTO BIG VITE 2RG DOPPIO TESTA ALTA Ometto BIG con vite 2 regolazioni doppio testa alta <i>Shutter stop</i>	33030295106	33032295107	15
	6,90	5,60	

OMETTI

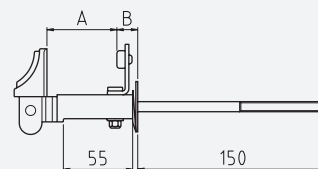

A=32-62
 B=20-55

	FZT	FZT+N	Conf. pz.
OMETTO BIG VITE 150 2RG	33030300006	33032300007	
Ometto BIG con vite mm 150 2 regolazioni			15
<i>Shutter stop</i>	8,00	7,20	
OMETTO BIG VITE 150 2RG TESTA ALTA	33030300106	33032300107	
Ometto BIG con vite mm 150 2 regolazioni testa alta			15
<i>Shutter stop</i>	8,50	7,30	

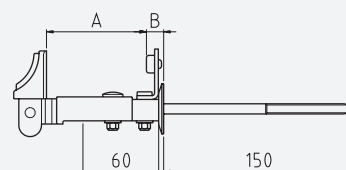

A=70-105
 B=20-45

	FZT	FZT+N	Conf. pz.
OMETTO BIG VITE 150 2RG SP. ANTA 70	33030301006	33032301007	
Ometto BIG con vite mm 150 2 regolazioni spessore anta mm 70			15
<i>Shutter stop</i>	8,90	8,00	
OMETTO BIG VITE 150 2RG SP. ANTA 70 TESTA ALTA	33030301106	33032301107	
Ometto BIG con vite mm 150 2 regolazioni sp. anta mm 70 testa alta			15
<i>Shutter stop</i>	9,20	8,10	

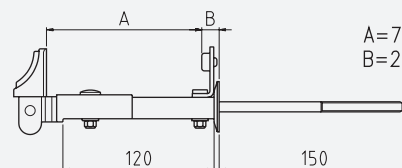

A=70-160
 B=20-105

	FZT	FZT+N	Conf. pz.
OMETTO BIG VITE 150 2RG DOPPIO	33030305006	33032305007	
Ometto BIG con vite mm 150 2 regolazioni doppio			10
<i>Shutter stop</i>	8,90	8,00	
OMETTO BIG VITE 150 2RG DOPPIO TESTA ALTA	33030305106	33032305107	
Ometto BIG con vite mm 150 2 regolazioni doppio testa alta			10
<i>Shutter stop</i>	9,20	8,10	

OMETTI

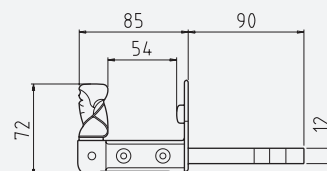
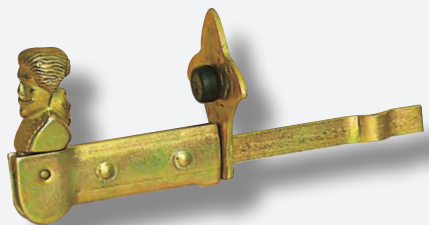

	FN	FZT	FZT+N	Conf. pz.
OMETTO FERMO ZANCA Ometto con fermo e zanca <i>Shutter stop</i>	33030100005	33030100006	33030100007	20
	4,00	4,00	4,40	

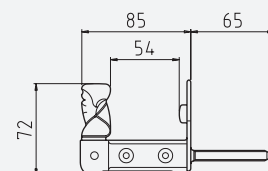
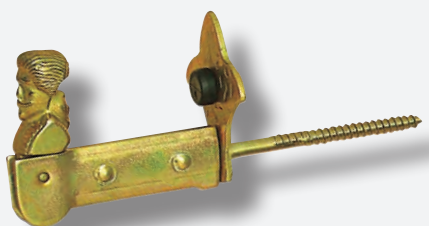

	FN	FZT	FZT+N	Conf. pz.
OMETTO FERMO VITE TAS Ometto con fermo vite e tassello <i>Shutter stop</i>	33030150005	33030150006	33030150007	20
	4,40	4,40	4,80	

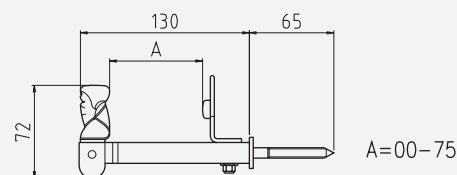
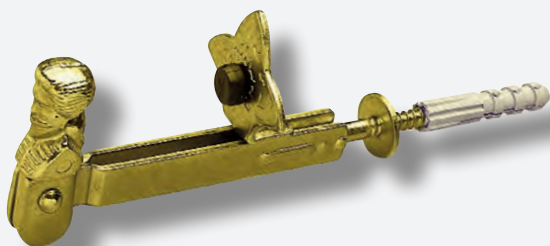

	FN	FZT	FZT+N	Conf. pz.
OMETTO FOGL REGIS VITE Ometto con foglia registrabile e vite <i>Shutter stop</i>	33030170005	33030170006	33030170007	20
	5,80	5,80	6,50	
OMETTO FOGL REGIS ZANCA Ometto con foglia registrabile e zanca <i>Shutter stop</i>	33030120005	33030120006	33030120007	20
	5,70	5,70	6,40	

OMETTI

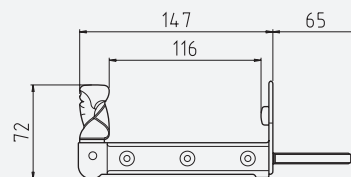
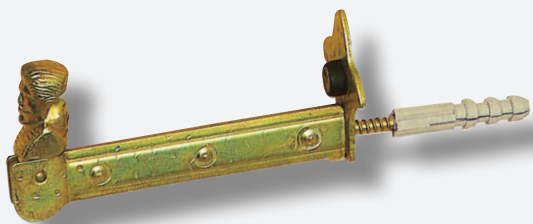

	FN	FZT	FZT+N	Conf. pz.
OMETTO FERMO VITE TAS DOP	33030155005	33030155006	33030155007	
Ometto con fermo vite e tassello doppio				15
<i>Shutter stop</i>	5,50	5,50	5,70	

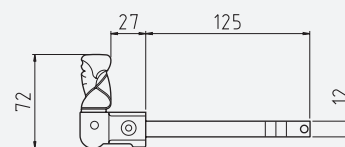

	FN	FZT	Conf. pz.
OMETTO ZANCA	33030000005	33030000006	
Ometto con zanca			30
<i>Shutter stop</i>	3,40	3,40	

OMETTI

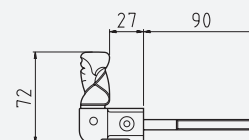

	FN	FZT	Conf. pz.
OMETTO VITE TAS	33030050005	33030050006	
Ometto con vite e tassello			30
<i>Shutter stop</i>	3,50	3,50	

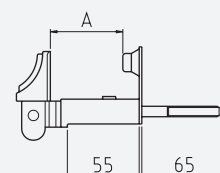

A=55-80

	FZT	FZT+N	Conf. pz.
OMETTO MODER VITE TAS	33030250006	33032250007	
Ometto moderno con vite e tassello			20
<i>Shutter stop</i>	5,80	4,40	

OMETTI

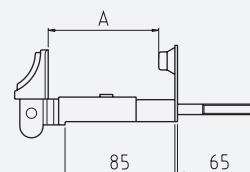

A=85-115

	FZT	FZT+N	Conf. pz.
OMETTO MODER VITE TAS DOP	33030255006	33032255007	
Ometto moderno con vite e tassello doppio			20
<i>Shutter stop</i>	5,80	4,40	

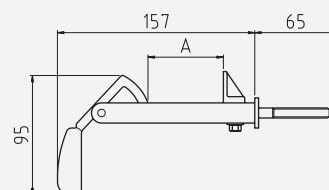

A=60 max

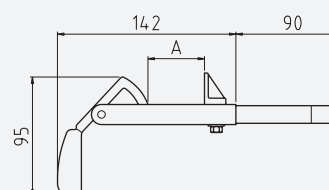

A=45 max

	FN	FZT	Conf. pz.
FERMAIMP VITE REG	33031055005	33031055006	
Fermailposte con vite regolabile			15
<i>Shutter stop</i>	6,20	6,20	
FERMAIMP ZANCA REG	33031005005	33031005006	
Fermailposte con zanca regolabile			15
<i>Shutter stop</i>	6,20	6,20	

	FZT	FZT+N	Conf. pz.
FERMAIMP REG MM.105 VITE C/MOLLA	33031052006	33031052007	
Fermailposte corto con vite regolabile con molla			20
<i>Shutter stop</i>	6,80	7,00	
FERMAIMP REG MM.125 VITE C/MOLLA	33031051006	33031051007	
Fermailposte corto con zanca regolabile con molla			15
<i>Shutter stop</i>	6,80	7,00	

OMETTI

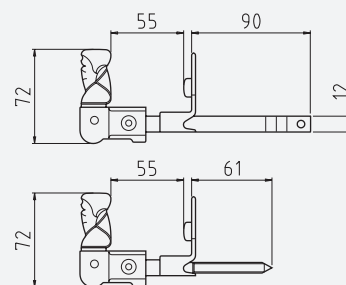
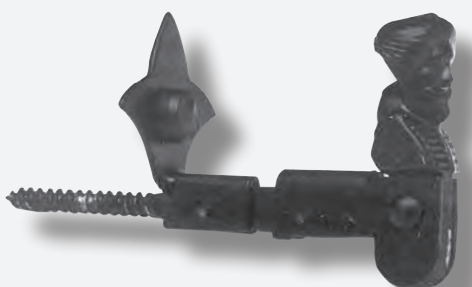

	FN	Conf. pz.
OMETTO FERMO ZANCA EC	33030140005	
Ometto con fermo e zanca economico	4,00	20
<i>Shutter stop</i>		
OMETTO FERMO VITE EC	33030190005	
Ometto con fermo e vite economico	4,10	20
<i>Shutter stop</i>		

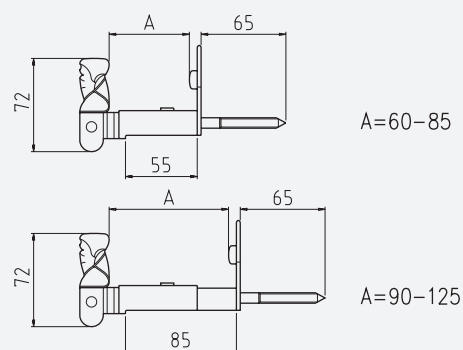
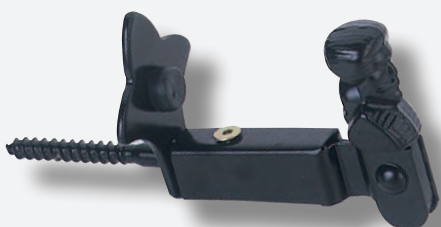

	FZT	FZT+N	Conf. pz.
OMETTO BIG FOGL REG VITE TAS	33030270006	33030270007	
Ometto Big regolabile con foglia vite tassello	5,60	6,00	20
<i>Shutter stop</i>			
OMETTO BIG FOGL REG VITE TAS DOP	33030275006	33030275007	
Ometto Big regolabile con foglia vite e tassello doppio	5,70	6,10	20
<i>Shutter stop</i>			

OMETTI

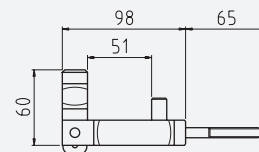
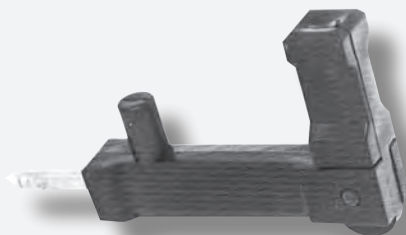

	NBR	NNE	Conf. pz.
OMETTO VITE NYLON	89300050000	89300050005	
Ometto in nylon con vite			40
<i>Shutter stop</i>	1,75	1,75	

METALMEC

MANIGLIE

DOOR HANDLES

CORNO	565
FARFALLA	565
LARA (MANIGLIA)	567
LARA (CREMONESE MP)	566
LARA (MARTELLINA)	567
MILANO	564
OLIMPIA	568
OLIVA (CREMONESE MP)	566
TORCIGLIONE	568
ZAMPA	569

ARTICOLI VARI

MISCELLANEOUS

MANIGLIA DA BLOCCO SAP	570
MANIGLIETTE FISSE	569-570



	ZMC	Conf. pz.
Q6 P70 Guarnitura Q6 placca patent 70 <i>Lever handle Q6 on key plate 70</i>	66802061003 8,10	8
Q8 P90 Guarnitura Q8 placca patent 90 <i>Lever handle Q8 on key plate 90</i>	66802089003 8,10	8
Q8 P70 Guarnitura Q8 placca patent 70 <i>Lever handle Q8 on key plate 70</i>	66802087003 8,10	8
Q8 PY85 Guarnitura Q8 placca yale 85 <i>Lever handle Q8 on cyl. plate 85</i>	66802088503 8,10	8
Q8 RB Guarnitura Q8 ros./bocc. patent <i>Lever handle Q8 on rose-key escutcheon</i>	66802281003 7,80	12
GZ PA Cremonese gioco GRAZ placca alta <i>window handle GRAZ mechanism</i>	66802401003 5,50	12
GZP PA Cremonese gioco GRAZ PERNI placca alta <i>window handle GRAZ PERNI mechanism</i>	66802402003 5,90	12
GZQ7 PA Cremonese gioco GRAZ Q7 placca alta <i>window handle GRAZ Q7 mechanism</i>	66802403003 5,70	12
MART PA Martellina Q7 placca alta <i>Window handle Q7</i>	66802500003 5,30	12
GZ PB Cremonese gioco GRAZ placca bassa <i>window handle GRAZ mechanism</i>	66802411003 5,50	12
GZP PB Cremonese gioco GRAZ PERNI placca bassa <i>window handle GRAZ PERNI mechanism</i>	66802412003 5,90	12
GZQ7 PB Cremonese gioco GRAZ Q7 placca bassa <i>window handle GRAZ Q7 mechanism</i>	66802413003 5,70	12

CORNO



	ZMC	Conf. pz.
Q6 P70 Guarnitura Q6 placca patent 70 <i>Lever handle Q6 on key plate 70</i>	66804061003 7,20	8
Q8 P90 Guarnitura Q8 placca patent 90 <i>Lever handle Q8 on key plate 90</i>	66804089003 7,20	8
Q8 P70 Guarnitura Q8 placca patent 70 <i>Lever handle Q8 on key plate 70</i>	66804087003 7,20	8
Q8 PY85 Guarnitura Q8 placca yale 85 <i>Lever handle Q8 on cyl. plate 85</i>	66804088503 7,20	8
Q6 BIL Bilancino Q6 <i>Pair of lever handle</i>	66804206003 8,10	12
Q8 BIL 1R Bilancino Q8 con 1 rosetta <i>Pair of lever handle with one rose</i>	66804261303 8,10	12
Q8 RB Guarnitura Q8 ros./bocc. patent <i>Lever handle Q8 on rose-key escutcheon</i>	66804281003 6,90	12
GZ PA Cremonese gioco GRAZ placca alta <i>Window handle GRAZ mechanism</i>	66804401003 5,10	12
GZP PA Cremonese gioco GRAZ PERNI placca alta <i>Window handle GRAZ PERNI mechanism</i>	66804402003 5,60	12
GZQ7 PA Cremonese gioco GRAZ Q7 placca alta <i>Window handle GRAZ Q7</i>	66804403003 5,40	12
MART PA Martellina Q7 placca alta <i>Window handle Q7</i>	66804500003 4,90	12
GZ PB Cremonese gioco GRAZ placca bassa <i>Window handle GRAZ mechanism</i>	66804411003 5,10	12
GZP PB Cremonese gioco GRAZ PERNI placca bassa <i>Window handle GRAZ PERNI mechanism</i>	66804412003 5,60	12
GZQ7 PB Cremonese gioco GRAZ Q7 placca bassa <i>Window handle GRAZ Q7</i>	66804413003 5,40	12

FARFALLA



	ZMC	Conf. pz.
Q6 P70 Guarnitura Q6 placca patent 70 <i>Lever handle Q6 on key plate 70</i>	66808061003 7,60	8
Q8 P90 Guarnitura Q8 placca patent 90 <i>Lever handle Q8 on key plate 90</i>	66808089003 7,60	8
Q8 P70 Guarnitura Q8 placca patent 70 <i>Lever handle Q8 on key plate 70</i>	66808087003 7,60	8
Q8 PY85 Guarnitura Q8 placca yale 85 <i>Lever handle Q8 on cyl. plate 85</i>	66808088503 7,60	8
Q8 RB Guarnitura Q8 ros./bocc. patent <i>Lever handle Q8 on rose-key escutcheon</i>	66808281003 7,10	12
GZ PA Cremonese gioco GRAZ placca alta <i>Window handle GRAZ mechanism</i>	66808401003 5,00	12
GZP PA Cremonese gioco GRAZ PERNI placca alta <i>Window handle GRAZ PERNI mechanism</i>	66808402003 5,50	12
GZQ7 PA Cremonese gioco GRAZ Q7 placca alta <i>Window handle GRAZ Q7 mechanism</i>	66808403003 5,30	12
MART PA Martellina Q7 placca alta <i>Window handle Q7</i>	66808500003 4,80	12
GZ PB Cremonese gioco GRAZ placca bassa <i>Window handle GRAZ mechanism</i>	66808411003 5,00	12
GZP PB Cremonese gioco GRAZ PERNI placca bassa <i>Window handle GRAZ PERNI mechanism</i>	66808412003 5,50	12
GZQ7 PB Cremonese gioco GRAZ Q7 placca bassa <i>Window handle GRAZ Q7 mechanism</i>	66808413003 5,30	12

LARA



	ZMC	ZMN	Conf. pz.
MPE + P + F	66820429003	66820429016	
Cremonese MP con passanti e finali			12
<i>Window handle MP</i>	5,90	5,80	

OLIVA



	ZMC	ZMN	Conf. pz.
MPE + P + F	66834429003	66834429016	
Cremonese MP con passanti e finali			12
<i>Window handle MP</i>	7,80	7,40	

LARA



	ZMC	ZMN	Conf. pz.
Q8 MM25 C/V Guarnitura Q8x25 con vite in testa <i>Door handle Q8X25</i>	66970000003	66970000016	12
Q8 MM35 C/V Guarnitura Q8x35 con vite in testa <i>Door handle Q8X35</i>	66970035003	66970035016	12
Q8 MM40 C/V Guarnitura Q8x40 con vite in testa <i>Door handle Q8 X 40</i>	66970040003	66970040016	12
Q8 MM45 C/V Guarnitura Q8x45 con vite in testa <i>Door handle Q8 X 45</i>	66970045003	66970045016	12
Q8 MM50 C/V Guarnitura Q8x50 con vite in testa <i>Door handle Q8X50</i>	66970050003	66970050016	12
Q8 MM60 C/V Guarnitura Q8x60 con vite in testa <i>Door handle Q8 X 60</i>	66970060003	66970060016	12
Q8 MM70 C/V Guarnitura Q8x70 con vite in testa <i>Door handle Q8 X70</i>	66970070003	66970070016	12
Q8 MM80 C/V Guarnitura Q8x80 con vite in testa <i>Door handle Q8 X 80</i>	66970080003	66970080016	12



	ZMC	ZMN	Conf. pz.
MART Q8 C/V Martellina Q8 x 15 con vite <i>Window handle Q8 X15 with screw</i>	66971000003	66971000016	12

TORCIGLIONE



	ZMN	Conf. pz.
Q8 C/V	66974000016	
Guarnitura Q8 con vite in testa		10
<i>Door handle Q8</i>	11,40	

OLIMPIA



	ZMC	ZMN	Conf. pz.
Q8 RP GRANO	66978000003	66978000016	
Guarnitura Q8 rosetta piccola con grano			12
<i>Door handle with small rose</i>	8,90	8,50	



	ZMN	Conf. pz.
Q8 PY42 BASCULANTE	66978842016	
Guarnitura Q8 placca Yale 42 per basculanti		8
<i>Door handle Q8 on plate cyl. 42mm</i>	16,30	

ZAMPA



	OLV	ZMN	Conf. pz.
Q8 RP SPINATA	49986000001	66982000016	
Guarnitura Q8 rosetta piccola spinata	11,00	8,00	10
<i>Door handle Q8 with small rose</i>			

MANIGLIETTE FISSE



	ZMC	Conf. pz.
MAN FISSA SCANN MM100	66912010003	
Maniglia fissa scannellata mm 100	2,40	50
<i>Fixed handle mm.100</i>		
MAN FISSA SCANN MM120	66912012003	
Maniglia fissa scannellata mm 120	3,05	50
<i>Fixed handle mm.120</i>		
MAN FISSA SCANN MM140	66912014003	
Maniglia fissa scannellata mm 140	3,30	50
<i>Fixed handle mm.140</i>		
MAN FISSA SCANN MM160	66912016003	
Maniglia fissa scannellata mm 160	4,10	50
<i>Fixed handle mm.160</i>		

MANIGLIETTE FISSE



	ZMN	Conf. pz.
MAN FISSA SAG MM150 Maniglia fissa sagomata mm 150 <i>Fixed handle mm.150</i>	66912150016	
	2,40	40

SAP



	ZTR	ZMN	Conf. pz.
MAN BLOCCO Maniglia da blocco <i>Safety lever handle</i>	66900000006	66900000016	
	10,80	10,80	12

ACCESSORI - SCHEMI DI MONTAGGIO *ACCESSORIES - ASSEMBLY INSTRUCTIONS*

GIOCHI CREMONESI	572
GIOCHI DK	573
MAGGIORAZIONI Q6, Q7, Q8	574
FERRI QUADRI Q6, Q7, Q8	574
FERRI QUADRI AD ESPANSIONE	575
FERRI QUADRI CON NIPLEX FOLLE	575
FERRI QUADRI CON PIASTRINA FOLLE	576
PIASTRINE	576
VITI	577
SCHEMI DI MONTAGGIO	578-579-580

GIOCHI PER CREMONESI



Fig. 1



Fig. 2



Fig. 3



Fig. 4



Fig. 5



Fig. 6



Fig. 7



Fig. 8



Fig. 9



Fig. 10



Fig. 11



Fig. 12



Fig. 13



Fig. 14

		Conf. pz.
Fig. 1	GIOCO MARTELLINA Q.7	13350000070
	<i>Mechanism for window handle spindle 7 mm</i>	3,90
Fig. 2	GIOCO EZ	13340600070
	<i>Mechanism for window handle spindle 7 mm</i>	3,90
Fig. 3	GIOCO EZ Q.7	13340700070
	<i>Mechanism for window handle spindle 7 mm</i>	4,30
Fig. 4	GIOCO GRAZ PERNI	13340200070
	<i>Mechanism for window handle spindle 7 mm</i>	4,30
Fig. 5	GIOCO GRAZ PERNI Q.7	13340900070
	<i>Mechanism for window handle spindle 7 mm</i>	4,70
Fig. 6	GIOCO MP	13340400070
	<i>Mechanism for window handle spindle 7 mm</i>	4,30
Fig. 7	GIOCO MP Q.7	13340500070
	<i>Mechanism for window handle spindle 7 mm</i>	4,70
Fig. 8	GIOCO GOLA LUPO CENTRALE	13340800070
	<i>Mechanism for window handle spindle 7 mm</i>	6,50
Fig. 9	GIOCO GOLA LUPO LATERALE	13340850070
	<i>Mechanism for window handle spindle 7 mm</i>	6,50
Fig. 10	GIOCO TIPO TOSCANO	13341500070
	<i>Mechanism for window handle spindle 7 mm</i>	3,90
Fig. 11	GIOCO CON ALETTE 14x20	13342400070
	<i>Mechanism for window handle spindle 7 mm</i>	4,30
Fig. 12	GIOCO CON ALETTE 11x33	13342400170
	<i>Mechanism for window handle spindle 7 mm</i>	4,30
Fig. 13	GIOCO GRAZ JOLLY DA APPLICARE	13341005070
	<i>Mechanism for window handle spindle 7 mm</i>	2,65
Fig. 14	GIOCO EZ JOLLY DA APPLICARE	13341105070
	<i>Mechanism for window handle spindle 7 mm</i>	3,05

GIOCHI DK

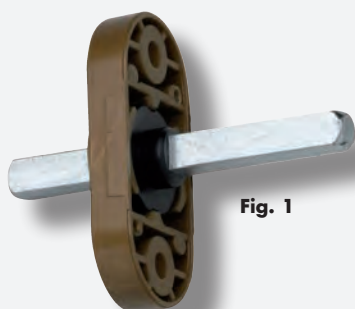

Fig. 1

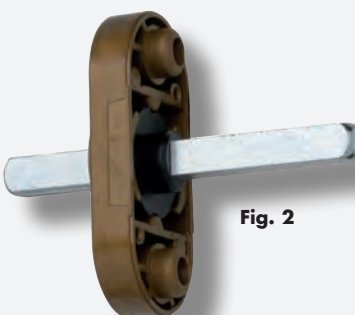

Fig. 2



Fig. 3



Fig. 4

	NOR	NAR
Fig. GIOCO DK Q7x30 OVALE 1 <i>Mechanism DK for window handle spindle 7 mm.</i>	18340000114	18340000115
	3,70	3,70
Fig. GIOCO DK Q7x33 OVALE 1 <i>Mechanism DK for window handle spindle 7 mm.</i>	18340000214	18340000215
	3,70	3,70
Fig. GIOCO DK Q7x40 OVALE 1 <i>Mechanism DK for window handle spindle 7 mm.</i>	18340000414	18340000415
	3,70	3,70
Fig. GIOCO DK Q7x45 OVALE 1 <i>Mechanism DK for window handle spindle 7 mm.</i>	18340000514	18340000515
	3,70	3,70

Fig. GIOCO DK Q7x30 OVALE C/BUSSOLE D.9,5 2 <i>Mechanism DK for window handle spindle 7 mm.</i>	18340100114	18340100115
	3,70	3,70
Fig. GIOCO DK Q7x33 OVALE C/BUSSOLE D.9,5 2 <i>Mechanism DK for window handle spindle 7 mm.</i>	18340100214	18340100215
	3,70	3,70
Fig. GIOCO DK Q7x40 OVALE C/BUSSOLE D.9,5 2 <i>Mechanism DK for window handle spindle 7 mm.</i>	18340100414	18340100415
	3,70	3,70
Fig. GIOCO DK Q7x45 OVALE C/BUSSOLE D.9,5 2 <i>Mechanism DK for window handle spindle 7 mm.</i>	18340100514	18340100515
	3,70	3,70

Fig. MAGGIORAZIONE PER BUSSOLE D.9,5-11,5 3 Conf. Pz. 500 <i>Special part for diam.of pin form 9.5 to 11.5 conf.</i>	18400820007
	0,25

Fig. GIOCO DK NYLON PER MARTELLINE 4 CON FORO Q7 PASSANTE <i>Mechanism DK for window handle spindle 7 mm.</i>	18342500011
	2,65



Fig. 1



Fig. 2



Fig. 3



Fig. 4



Fig. 5

FERRI

Fig. 1	MAGGIORAZIONE 6x7x20 FERRO <i>Adaptor spindle 6x7x20</i>	1328000011 0,50
Fig. 1	MAGGIORAZIONE 6x8x20 FERRO <i>Adaptor spindle 6x8x20</i>	13280100011 0,50
Fig. 1	MAGGIORAZIONE 7x8x20 FERRO <i>Adaptor spindle 7x8x20</i>	13280200011 0,50
Fig. 2	FERRO Q6x120 SENZA TAGLI <i>Spindle Q6x120 without cutting</i>	13210012070 0,95
Fig. 3	FERRO Q7x 65 SENZA TAGLI <i>Spindle Q7x65 without cutting</i>	13220006570 0,80
Fig. 3	FERRO Q7x 70 SENZA TAGLI <i>Spindle Q7x70 without cutting</i>	13220007070 0,80
Fig. 3	FERRO Q7x 75 SENZA TAGLI <i>Spindle Q7x75 without cutting</i>	13220007570 0,80
Fig. 4	FERRO Q7x59 (DK FISSO SPORG.30) <i>Spindle DK</i>	13225006170 0,65
Fig. 4	FERRO Q7x62 (DK FISSO SPORG.33) <i>Spindle DK</i>	13225000170 0,75
Fig. 4	FERRO Q7x64 (DK FISSO SPORG.35-30) <i>Spindle DK</i>	13225006670 0,80
Fig. 4	FERRO Q7x69 (DK FISSO SPORG.40-35) <i>Spindle DK</i>	13225007170 0,85
Fig. 4	FERRO Q7x74 (DK FISSO SPORG.45-40) <i>Spindle DK</i>	13225007670 0,90
Fig. 5	FERRO Q8x100 2 TAGLI + FRESATURA <i>Spindle Q8 X100</i>	13230410070 1,10
Fig. 5	FERRO Q8x120 2 TAGLI + FRESATURA <i>Spindle Q8X120</i>	13230412070 1,10
Fig. 5	FERRO Q8x140 2 TAGLI + FRESATURA <i>Spindle Q8X140</i>	13230414070 1,10
Fig. 5	FERRO Q8x160 2 TAGLI + FRESATURA <i>Spindle Q8X160</i>	13230416070 1,10
	FERRO Q6x1000 (VERGA) <i>Spindle Q6x1000 (rod)</i>	13175610011 3,60
	FERRO Q7x1000 (VERGA) <i>Spindle Q7x1000 (rod)</i>	13175710011 3,60
	FERRO Q8x1000 (VERGA) <i>Spindle Q8x1000 (rod)</i>	13175810011 3,60



FERRI

FERRO Q8x43 AD ESPANSIONE	13230500006
<i>Special spindle Q8x43</i>	2,65
FERRO Q8x55 AD ESPANSIONE	13230500106
<i>Special spindle Q8x55</i>	2,80
FERRO Q8x65 AD ESPANSIONE	13230500206
<i>Special spindle Q8x65</i>	2,80
FERRO Q8x80 AD ESPANSIONE	13230500306
<i>Special spindle Q8x80</i>	2,95

FERRO Q8x 95 CON NIPLEX M10 FOLLE	13233609570
<i>Spindle Q8x95 with nipler M10 free</i>	2,20
FERRO Q8x100 CON NIPLEX M10 FOLLE	13233600170
<i>Spindle Q8x100 with nipler M10 free</i>	2,20
FERRO Q8x105 CON NIPLEX M10 FOLLE	13233610570
<i>Spindle Q8x105 with nipler M10 free</i>	2,20
FERRO Q8x110 CON NIPLEX M10 FOLLE	13233600270
<i>Spindle Q8x110 with nipler M10 free</i>	2,20
FERRO Q8x115 CON NIPLEX M10 FOLLE	13233611570
<i>Spindle Q8x115 with nipler M10 free</i>	2,20
FERRO Q8x120 CON NIPLEX M10 FOLLE	13233612070
<i>Spindle Q8x120 with nipler M10 free</i>	2,20
FERRO Q8x130 CON NIPLEX M10 FOLLE	13233613070
<i>Spindle Q8x130 with nipler M10 free</i>	2,20

DISPONIBILI FINO AD ESAURIMENTO SCORTE

FERRO Q8x 95 CON NIPLEX MB 14 FOLLE	13230600070
<i>Spindle Q8x95 with nipler MB 14 free</i>	2,20
FERRO Q8x100 CON NIPLEX MB 14 FOLLE	13230600170
<i>Spindle Q8x100 with nipler MB 14 free</i>	2,20
FERRO Q8x105 CON NIPLEX MB 14 FOLLE	13230600270
<i>Spindle Q8x105 with nipler MB 14 free</i>	2,20
FERRO Q8x110 CON NIPLEX MB 14 FOLLE	13230600370
<i>Spindle Q8x110 with nipler MB 14 free</i>	2,20
FERRO Q8x115 CON NIPLEX MB 14 FOLLE	13230600670
<i>Spindle Q8x115 with nipler MB 14 free</i>	2,20
FERRO Q8x120 CON NIPLEX MB 14 FOLLE	13230600470
<i>Spindle Q8x120 with nipler MB 14 free</i>	2,20
FERRO Q8x130 CON NIPLEX MB 14 FOLLE	13230600570
<i>Spindle Q8x130 with nipler MB 14 free</i>	2,20

FERRI CON PIASTRINE



FERRO Q8x100 CON PIASTRINA Q8x30 FOLLE	13230800070
<i>Special spindle</i>	2,95
FERRO Q8x 85 CON PIASTRINA Q8x30 FOLLE	13230800170
<i>Special spindle</i>	2,95
FERRO Q8x 70 CON PIASTRINA Q8x30 FOLLE	13230800270
<i>Special spindle</i>	2,95

PIASTRINE

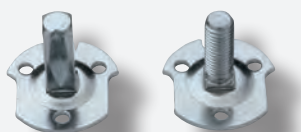

PIASTRINA D.32 Q8x25	13320010270
<i>Item for fixing lever handle or knob</i>	2,40
PIASTRINA D.32 C/VITE M8x25	13320110070
<i>Item for fixing lever handle or knob</i>	2,70

VITI



CONF. 10 VITI TP+3X16 E 2 GRANI M6X6 PER QUARNITURE SU ROSETTA 19000005006
0,30



CONF. 4 VITI TGS+3,5X25 OTTONE E 2 GRANI M6X6 PER QUARNITURE SU PLACCA 19000005101
0,35

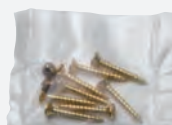

CONF. 8 VITI TGS+3,5X25 OTTONE E 2 GRANI M6X6 PER QUARNITURE SU PLACCA 19000005201
0,40



CONF. 2 VITI TP+M5X35 PER DK 19000006770
0,25

CONF. 2 VITI TP+M5X40 PER DK 19000001770
0,25

CONF. 2 VITI TP+M5X45 PER DK 19000004870
0,25

CONF. 2 VITI TP+M5X50 PER DK 19000008570
0,30

CONF. 500 VITI TP+M5X35 PER DK 19000005670
26,70

CONF. 500 VITI TP+M5X40 PER DK 19000005370
28,60

CONF. 500 VITI TP+M5X45 PER DK 19000005470
33,90

CONF. 500 VITI TP+M5X50 PER DK 19000005570
43,80

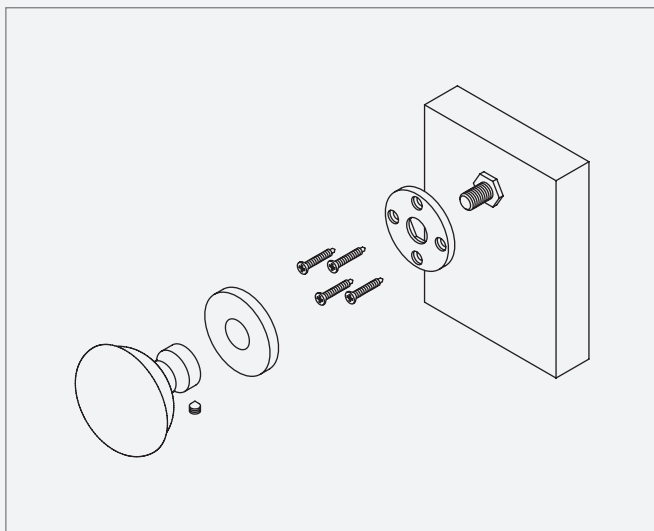

Pomolo centroporta

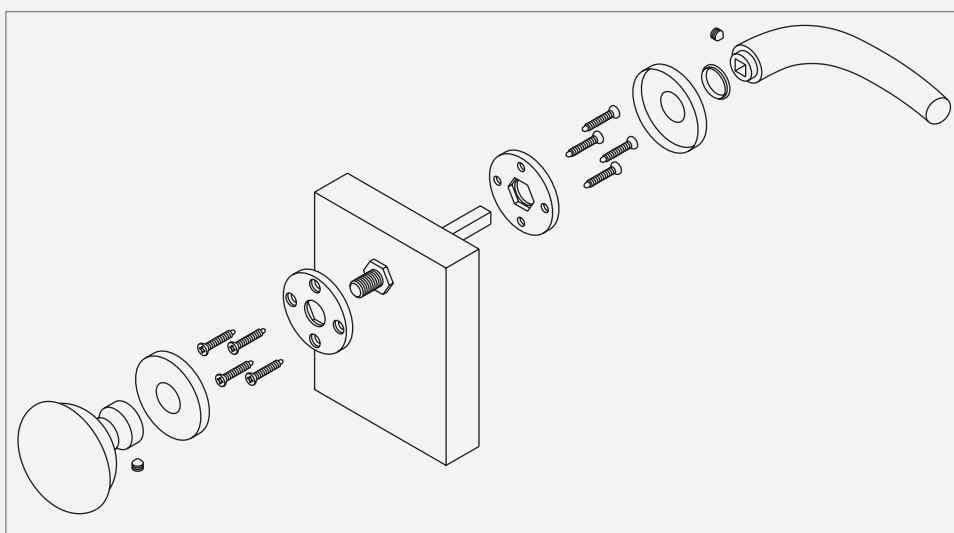

Pomolo fisso +
maniglia girevole
per porta blindata

Guarnitura Hotel su placca con
viti passanti

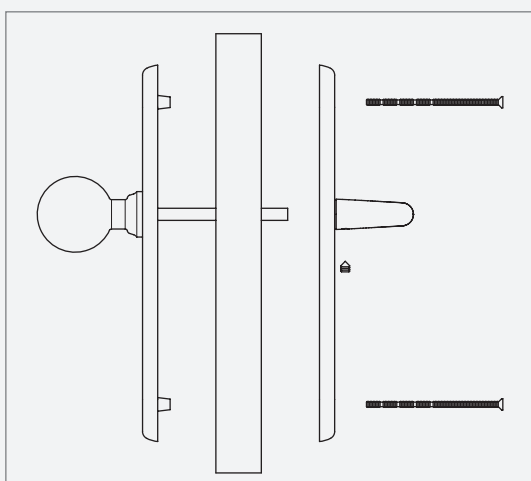

Guarnitura Hotel su rosetta/bocchetta

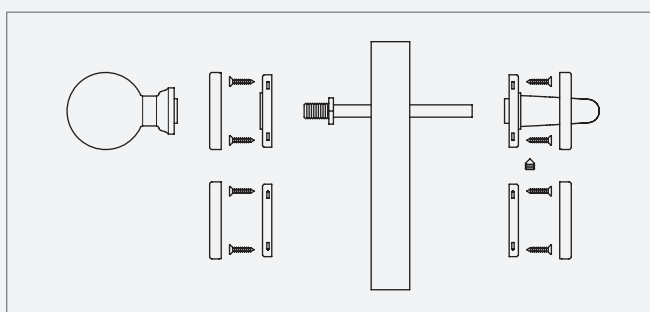

SCHEMI DI MONTAGGIO

Maniglione senza rosette singolo

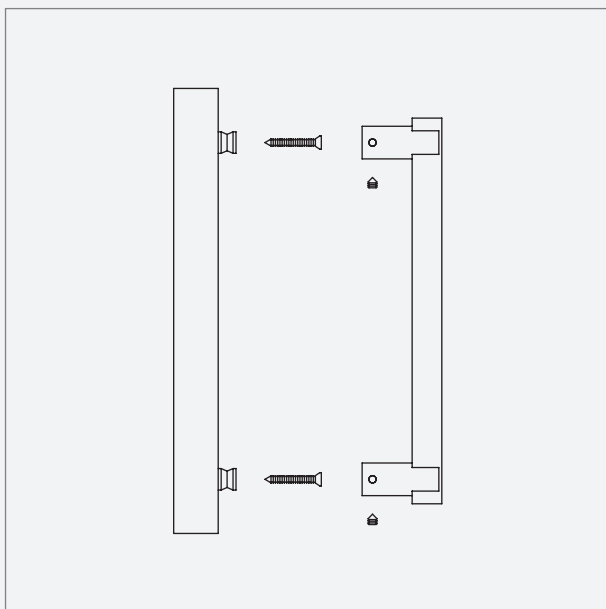

Coppia maniglioni senza rosette per vetro, legno, alluminio

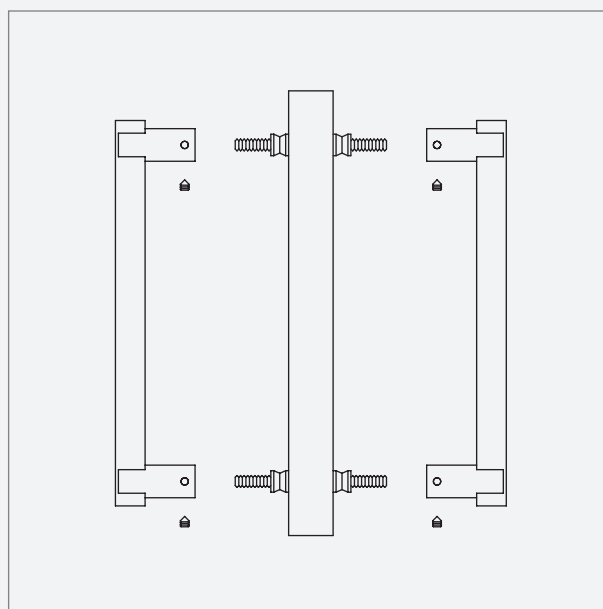

Maniglione con rosette singolo

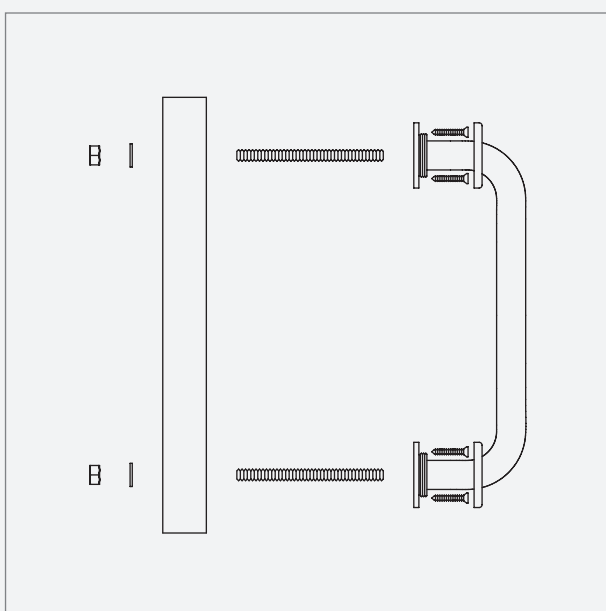

Coppia maniglioni con rosette per vetro, legno, alluminio

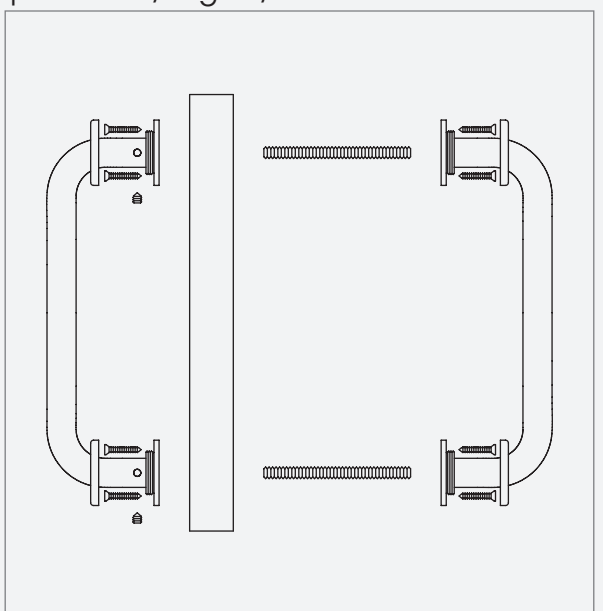

SCHEMI DI MONTAGGIO

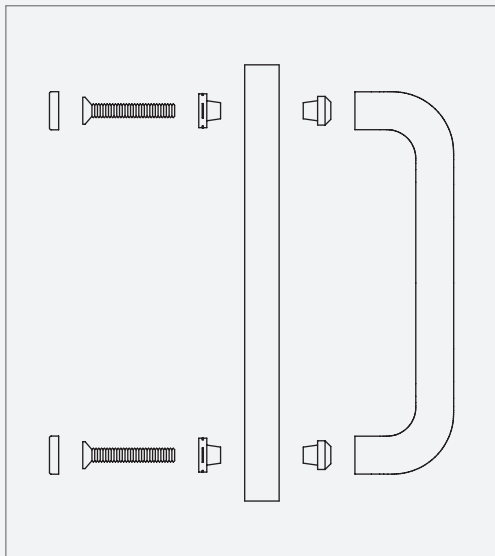

Maniglione LIA singolo

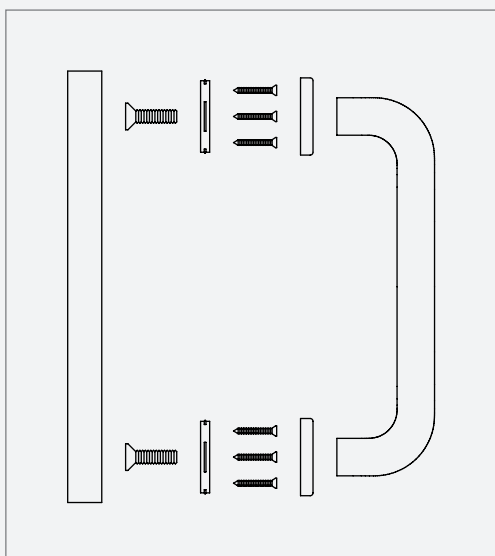

Maniglione LIA singolo con rosone

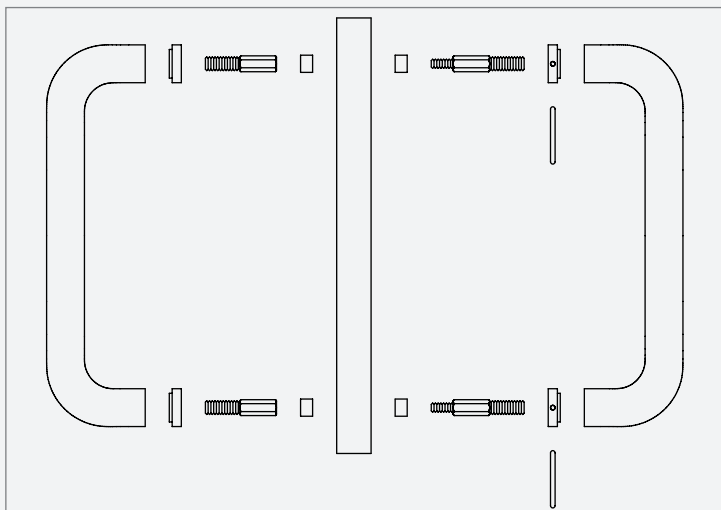

Coppia maniglione LIA per vetro,
legno, alluminio

ESPOSITORI

DISPLAYS FOR SAMPLES



**ESPOSITORE A PAVIMENTO MOD.2007
CON 10 PANNELLI CM 21,5X31,5 INTERCAMBIABILI**

19005500200	Base cm.	Altezza cm.
1.323,00	Ø 50	220

Disponibile a richiesta con
pannelli cm 21,5x10,5
intercambiabili

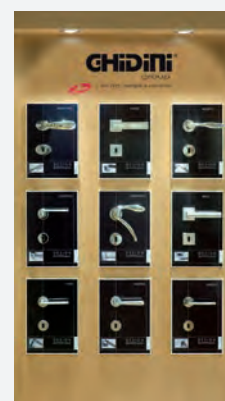

**MODULO PER ESPOSIZIONE CON 9 PANNELLI
CM 21,5X31,5 INTERCAMBIABILI**

19005500100

1.190,70

Base
cm.

90

Altezza
cm.

210

Disponibile a richiesta con
pannelli intercambiabili
con grafica DESIGN



Fig. 1



Fig. 2

Fig. 1	ESPOSITORE DA BANCO DESIGN CON 8 MODELLI FISSI	19005700200	Base cm.	Altezza cm.
		136,50	30	41
Fig. 2	ESPOSITORE DA BANCO CLASSICO CON 8 MODELLI FISSI	19005700300	Base cm.	Altezza cm.
		136,50	30	41
	ESPOSITORE DA BANCO DESIGN/CLASSICO CON 8 MODELLI FISSI	19005700400	Base cm.	Altezza cm.
		136,50	30	41



ESPOSITORE A PARETE 6 MODELLI FISSI

19005300600	Base cm.	Altezza cm.
136,70	47	93



PANNELLO ESPOSITIVO BIANCO	19005401000	Base cm.	Altezza cm.
		21,5	10,5



PANNELLO ESPOSITIVO BIANCO	19005401500	Base cm.	Altezza cm.
		21,5	31,5



PANNELLO ESPOSITIVO DESIGN	19005402000	Base cm.	Altezza cm.
		21,5	31,5



ESPOSITORE DA BANCO CON GRAFICA DESIGN E PLEXIGLASS	19005700010
--	--------------------



ESPOSITORE "MORFEO" CON PANNELLO CM 21,5X31,5	19005800000
--	--------------------



**ESPOSITORE VETRINETTA COLLEZIONE
DE VENIERI**

19005700900

Base
cm.

Altezza
cm.

Profondità
cm.

52

30

14



CONDIZIONI GENERALI DI VENDITA

PREZZI:

Il prezzo di listino è riferito a N°1 pezzo dell'articolo con codice ad esso riferito IVA esclusa con resa franco partenza e imballo quantificato nella misura del 1% dell'imponibile in fattura.

SPEDIZIONI:

La merce viaggia in ogni caso a rischio e pericolo del committente.

In assenza di precise istruzioni circa il mezzo di inoltro della merce le spedizioni sono eseguite nel modo ritenuto più idoneo ed economico senza nessuna responsabilità della Casa.

PAGAMENTI:

Devono essere effettuati direttamente al domicilio della nostra sede o mediante estinzione di nostre ricevute bancarie entro la scadenza concordata. Eventuali ritardi comportano il conteggio degli interessi di mora.

ORDINI:

Tutti gli ordini devono essere inoltrati ai nostri agenti di zona utilizzando codici e descrizioni corrette di quanto richiesto.

Eventuali ordini inviati direttamente alla nostra sede sono accettati solo se trasmessi a mezzo telefax e completi di codici e descrizioni corretti di quanto richiesto.

Ogni articolo richiesto in quantità inferiore al numero di pezzi previsti nella confezione standard subirà un aumento prezzo del 10%.

Tutti gli ordini, in ogni caso, sono subordinati all'approvazione della Casa.

FATTURAZIONE:

Il minimo importo netto merce fatturabile è di € 150,00.

TERMINI DI CONSEGNA:

Il termine di consegna e di spedizione, anche se confermato, costituisce una semplice previsione ed ha perciò un valore indicativo, quindi non comporta nessuna garanzia e nessun indennizzo è dovuto per la mancata consegna nel termine previsto.

ARTICOLI:

Tutti gli articoli presentati con il precedente Listino Illustrato 2012, ma non citati in questa edizione sono usciti di produzione, pertanto eventuali ordini in corso saranno evasi fino ad esaurimento delle scorte.

Ogni variante rispetto agli articoli a listino è da considerarsi prodotto speciale per il quale, di volta in volta, è necessario richiedere fattibilità, quantità minima, prezzo.

La fornitura di prodotti speciali a richiesta è subordinata all'accettazione da parte del committente della relativa conferma d'ordine.

La Casa si riserva il diritto di approvare modifiche agli articoli e variazione dei prezzi senza preavviso.



CONDIZIONI GENERALI DI VENDITA

RESI:

Non si accettano resi di merce standard, se non espressamente autorizzati dalla Casa.

Le contestazioni, comunque, devono essere fatte entro 8 giorni dal ricevimento della merce.

Le richieste di reso devono pervenire a mezzo fax, verranno analizzate ed eventualmente autorizzate mediante apposita "**Scheda di Autorizzazione Reso**" indicante tutte le modalità e condizioni alle quali verrà accettato il reso. Qualsiasi reso pervenuto senza preavviso ed autorizzazione verrà respinto al mittente.

Per prodotti speciali approntati a richiesta non si accettano resi per alcun motivo.

Per qualsiasi controversia è competente il Foro di Brescia.



GENERAL TERMS AND CONDITIONS OF SALE

ORDERS:

All direct and indirect Orders are subject to our approval and cannot be revoked by the Buyer.

DELIVERIES:

The delivery terms are approximate. In case of delays in the execution of an Order or partial shipments, the Seller will not be liable for damages.

SHIPMENTS:

Even if the goods are supplied free destination, they are forwarded at the exclusive risk of the Buyer who is obliged to collect them. In case of non-collection the damages ensuing from this will be entirely at the Buyer's expense.

CLAIMS:

No claims can be considered unless made within seven days of delivery of the goods. In case of a recognized imperfection of the product, it will be replaced, on the understanding that it has not been put into use.

PAYMENTS:

All payments must be made within the terms agreed upon and exclusively to our domicile. In case of delays the Seller will be entitled to a Credit Surcharge of three percent above the official interest rate.

Discounts or deductions are not accepted, unless previously authorized.

JURISDICTION:

For any controversy the only competent instance is the Court of Justice of Brescia.